



S-Class Operator's Manual



Mercedes-Benz

S 430

S 430 4MATIC

S 500

S 500 4MATIC

S 55 AMG

S 600

Our company and staff congratulate you on the purchase of your new Mercedes-Benz.

Your selection of our product is a demonstration of your trust in our company name. Furthermore, it exemplifies your desire to own an automobile that will be as easy as possible to operate and provide years of service.

Your Mercedes-Benz represents the efforts of many skilled engineers and craftsmen. To help assure your driving pleasure, and also the safety of you and your passengers, we ask you to make a small investment of time:

- Please read this manual carefully, then return it to your vehicle where it will be handy for your reference.
- Please follow the recommendations contained in this manual. They are designed to acquaint you with the operation of your Mercedes-Benz.
- Please pay attention to the warnings and cautions contained in this manual. They are designed to help improve the safety of the vehicle operator and occupants.

We extend our best wishes for many miles of safe, pleasurable driving.

Mercedes-Benz USA, LLC  
A DaimlerChrysler Company

## Contents

<b>Introduction</b> .....	9	<b>At a glance</b> .....	19	<b>Getting started</b> .....	29
Product information .....	9	Cockpit .....	20	Unlocking .....	30
Operator's Manual .....	10	Instrument cluster .....	22	Unlocking with the SmartKey .....	30
Service and warranty information ..	10	Multifunction steering wheel .....	24	Unlocking with KEYLESS-GO* .....	32
Important notice for California		Center console .....	25	Adjusting .....	34
retail buyers and lessees of		Upper part .....	25	Seats .....	34
Mercedes-Benz automobiles .....	11	Lower part .....	26	Steering wheel .....	37
Maintenance .....	12	Overhead control panel .....	27	Mirrors .....	38
Roadside Assistance .....	12	Door control panel .....	28	Driving .....	40
Change of address or ownership....	12			Fastening the seat belts .....	40
Operating your vehicle outside				Starting the engine .....	43
the USA or Canada .....	13			Switching on headlamps .....	47
Where to find it .....	14			Turn signals and high beam .....	47
Symbols .....	15			Windshield wipers .....	48
Operating safety .....	16			Problems while driving .....	50
Proper use of the vehicle .....	16			Parking and locking .....	51
Problems with your vehicle .....	17			Parking brake .....	52
Reporting safety defects .....	18			Switching off headlamps .....	53
Reporting safety defects .....	18			Turning off the engine .....	53

## Contents

<b>Safety and Security</b> .....	57	<b>Controls in detail</b> .....	87	Rear seat head restraints.....	110
Occupant safety.....	58	Locking and unlocking.....	88	Lumbar support .....	112
Airbags.....	59	SmartKey .....	88	Multicontour backrest* .....	112
Seat belts.....	64	SmartKey with KEYLESS-GO* .....	91	Drive-dynamic seat* .....	113
Preventive occupant safety (PRE-SAFE).....	68	Opening the doors from the inside.	96	Seat heating* .....	114
Children in the vehicle.....	69	Opening the trunk lid from the outside .....	97	Seat ventilation* .....	117
Override switch for rear passenger compartment.....	74	Opening the trunk lid from the inside .....	97	Rear seats.....	118
Panic alarm.....	76	Closing the trunk lid.....	98	Memory function .....	121
Activating .....	76	Trunk lid opening/closing system* .....	99	Storing positions into memory .....	122
Deactivating .....	76	Trunk lid emergency release .....	104	Recalling positions from memory.....	122
Driving safety systems.....	77	Separately locking the trunk lid ...	105	Storing exterior rear view mirror parking position .....	122
ABS .....	77	Separately unlocking the trunk lid	105	Lighting .....	124
BAS .....	78	Power closing assist for doors and trunk lid.....	106	Exterior lamp switch .....	124
ESP.....	79	Automatic central locking .....	106	Combination switch .....	128
Four wheel electronic traction system (4MATIC) with the ESP .....	82	Locking and unlocking from the inside .....	107	Hazard warning flasher .....	128
Anti-theft systems.....	83	Seats .....	108	Interior lighting .....	129
Immobilizer.....	83	Easy-entry/exit feature .....	108	Courtesy lighting.....	130
Anti-theft alarm system.....	83	Removing and installing front seat head restraints.....	109	Instrument cluster .....	131
Tow-away alarm .....	85			Instrument cluster illumination ....	131
				Coolant temperature gauge .....	132
				Trip odometer .....	132
				Tachometer.....	133
				Outside temperature indicator .....	133

## Contents

Control system .....	134	Good visibility .....	174	Ventilated storage compartment (except S 55 AMG) .....	192
Multifunction display.....	134	Rear view mirror .....	174	Rear passenger compartment adjustable air vents .....	192
Multifunction steering wheel.....	135	Electrically folding exterior rear view mirrors .....	176	Rear passenger compartment climate control* .....	193
Menus .....	137	Windshield wipers .....	177	Power windows .....	195
Standard display menu .....	139	Headlamp cleaning system* (Standard on S 500, S 600, S 55 AMG) .....	177	Opening and closing the windows	195
AUDIO menu .....	139	Sun visors .....	178	Synchronizing the power windows	198
CD changer* operating mode .....	142	Rear window sunshade* .....	179	Sliding/pop-up roof.....	199
TEL menu* .....	144	Rear door window sunshade* .....	179	Opening and closing the sliding/pop-up roof.....	199
NAVI menu.....	147	Automatic climate control .....	180	Synchronizing the sliding / pop-up roof.....	202
Distronic* menu.....	147	Setting the temperature.....	183	Driving systems.....	203
Trip computer menu.....	148	Adjusting air distribution.....	184	Cruise control .....	203
Malfunction memory menu .....	150	Adjusting air volume .....	186	Distronic* .....	206
Settings menu.....	151	Maximum cooling MAXCOOL.....	186	AIRMATIC .....	218
Automatic transmission.....	164	Defrosting .....	187	Active Body Control (ABC)* .....	220
One-touch gearshifting.....	165	Air recirculation mode .....	187	Parktronic* (Parking assist) .....	224
Gear ranges .....	166	Charcoal filter .....	188	Loading .....	229
Gear selector lever position .....	167	Rear window defroster .....	189	Roof rack* .....	229
Steering wheel gearshift control (Speedshift) S 55 AMG.....	168	Deactivating the climate control system .....	190	Loading instructions .....	229
Program mode selector switch.....	170	Air conditioning.....	190	Cargo tie-down hooks.....	230
Accelerator position.....	170	Residual heat and ventilation.....	191		
Manual shift program S 55 AMG..	171				
Emergency operation (Limp home mode).....	173				

## Contents

Useful features .....	231		
Storage compartments.....	231		
Ashtrays .....	238		
Cigarette lighters.....	239		
Heated steering wheel* .....	240		
Telephone* .....	241		
Tele Aid .....	242		
Garage door opener .....	250		
Infrared reflecting windshield.....	256		
		<b>Operation .....</b>	<b>257</b>
		The first 1000 miles (1500 km) .....	258
		Driving instructions.....	259
		Drive sensibly – save fuel.....	259
		Drinking and driving .....	259
		Pedals .....	259
		Power assistance .....	259
		Brakes.....	260
		Driving off .....	261
		Parking.....	261
		Tires .....	262
		Hydroplaning.....	263
		Tire traction.....	263
		Tire speed rating .....	263
		Winter driving instructions .....	264
		Standing water .....	265
		Passenger compartment .....	266
		Driving abroad.....	266
		Control and operation of radio	
		transmitters .....	266
		Catalytic converter.....	267
		Emission control .....	267
		Coolant temperature.....	268
		At the gas station .....	269
		Refueling.....	269
		Check regularly and before a	
		long trip .....	270
		Engine compartment .....	272
		Hood .....	272
		Engine oil .....	273
		Transmission fluid level.....	278
		Active Body Control* (ABC*)	
		fluid level .....	278
		Coolant .....	278
		Battery .....	280
		Windshield washer system and	
		headlamp cleaning system* .....	281
		Tires and wheels.....	282
		Important guidelines .....	282
		Life of tires.....	283
		Direction of rotation.....	283
		Checking tire inflation pressure ...	283
		Rotating wheels .....	291
		Winter driving .....	292
		Winter tires .....	292
		Block heater (Canada only).....	293
		Snow chains.....	293





## Contents

<b>Technical data</b> .....	377	Fuels, coolants, lubricants, etc. ....	391	<b>Technical terms</b> .....	401
Spare parts service .....	378	Capacities .....	391		
Warranty coverage.....	379	Engine oils.....	393		
Loss of Service and Warranty		Engine oil additives .....	393	<b>Index</b> .....	407
Information Booklet.....	379	Air conditioning refrigerant .....	393		
Identification labels.....	380	Brake fluid.....	394		
Layout of poly-V-belt drive .....	381	Premium unleaded gasoline .....	394		
S 430 / S 500 (all models).....	381	Fuel requirements .....	394		
S 55 AMG.....	381	Gasoline additives .....	395		
S 600 .....	381	Coolants.....	395		
Engine.....	382	Windshield and headlamp washer			
Rims and tires.....	384	system .....	398		
Same size tires.....	385	Consumer information .....	399		
Mixed size tires .....	387	Uniform tire quality grading .....	399		
Spare wheel .....	388				
Electrical system.....	389				
Main dimensions and weights.....	390				
Main dimensions .....	390				
Weights .....	390				

▼ **Product information**

Please observe the following in your own best interest:

We recommend using genuine Mercedes-Benz parts as well as conversion parts and accessories explicitly approved by us for your vehicle model.

We have tested these parts to determine their reliability, safety and special suitability for Mercedes-Benz vehicles.

We are unable to make an assessment for other products and therefore cannot be held responsible for them, even if in individual cases an official approval or authorization by governmental or other agencies should exist. Use of such parts and accessories could adversely affect the safety, performance or reliability of your vehicle. Please do not use them.

Genuine Mercedes-Benz parts as well as conversion parts and accessories approved by us are available at your authorized Mercedes-Benz Center where you will receive comprehensive information, also on permissible technical modifications, and where proper installation will be performed.

## Introduction

### Operator's Manual

#### ▼ Operator's Manual

This Operator's Manual contains a great deal of useful information. We urge you to read it carefully and familiarize yourself with the vehicle before driving.

For your own safety and longer service life of the vehicle, we urge you to follow the instructions and warnings contained in this manual. Ignoring them could result in damage to the vehicle or personal injury to you or others. Vehicle damage caused by failure to follow instructions is not covered by the Mercedes-Benz Limited Warranty.

Your vehicle may have some or all of the equipment described in this manual. Therefore, you may find explanations for optional equipment not installed in your vehicle. If you have any questions about the operation of any equipment, your authorized Mercedes-Benz Center will be glad to demonstrate the proper procedures.

We continuously strive to improve our product, and ask for your understanding that we reserve the right to make changes in design and equipment. Therefore, information, illustrations and descriptions in this Operator's Manual might differ from your vehicle.

Optional equipment is also described in this manual, including operating instructions wherever necessary. Since they are special-order items, the descriptions and illustrations herein may vary slightly from the actual equipment of your vehicle.

If there are any equipment details that are not shown or described in this Operator's Manual, your authorized Mercedes-Benz Center will be glad to inform you of correct care and operating procedures.

The Operator's Manual and Service Booklet are important documents and should be kept with the vehicle.

#### Service and warranty information

The Service and Warranty Information Booklet contains detailed information about the warranties covering your Mercedes-Benz, including:

- New Car Limited Warranty
- Emission System Warranty
- Emission Performance Warranty
- California, Maine, Massachusetts, and Vermont Emission Control System Warranty (California, Maine, Massachusetts, and Vermont only)
- State Warranty Enforcement Laws (Lemon Laws)

**Important notice for California retail buyers and lessees of Mercedes-Benz automobiles**

Under California law you may be entitled to a replacement of your vehicle or a refund of the purchase price or lease price, if Mercedes-Benz USA, LLC and / or its authorized repair or service facilities fail to fix one or more substantial defects or malfunctions in the vehicle that are covered by its express warranty after a reasonable number of repair attempts. During the period of 18 months from original delivery of the vehicle or the accumulation of 18 000 miles (approx. 29 000 km) on the odometer of the vehicle, whichever occurs first, a reasonable number of repair attempts is presumed for a retail buyer or lessee if one or more of the following occurs:

- (1) the same substantial defect or malfunction results in a condition that is likely to cause death or serious bodily injury if the vehicle is driven, that defect or malfunction has been subject to repair two or more times, and you have directly notified Mercedes-Benz USA, LLC in writing of the need for its repair,
- (2) the same substantial defect or malfunction of a less serious nature than category (1) has been subject to repair four or more times and you have directly notified us in writing of the need for its repair, or
- (3) the vehicle is out of service by reason of repair of the same or different substantial defects or malfunctions for a cumulative total of more than 30 calendar days. Written notification should be sent to us, not a dealer, at Mercedes-Benz USA, LLC, Customer Assistance Center, One Mercedes Drive, Montvale, NJ 07645-0350.

## Introduction

### Operator's Manual

#### Maintenance

---

The Service Booklet describes all the necessary maintenance work which should be performed at regular intervals.

Always have the Service Booklet with you when you take the vehicle to your authorized Mercedes-Benz Center for service. The service advisor will record each service in the booklet for you.

#### Roadside Assistance

---

The Mercedes-Benz Roadside Assistance Program provides factory trained technical help in the event of a breakdown. Calls to the toll-free Roadside Assistance number

**1-800-FOR-MERCEdes (in the USA)**  
**1-800-387-0100 (in Canada)**

will be answered by Mercedes-Benz Customer Assistance Representatives 24 hours a day, 365 days a year.

For additional information refer to the Mercedes-Benz Roadside Assistance Program Brochure in your glove box.

#### Change of address or ownership

---

If you change your address, be sure to send in the "Change of Address Notice" found in the Service and Warranty Information Booklet, or simply call the Mercedes-Benz Customer Assistance Center (in the USA) at 1-800-FOR-MERCEdes, or Customer Service (in Canada) at 1-800-387-0100. It is in your own interest that we can contact you should the need arise.

If you sell your Mercedes, please leave all literature with the vehicle to make it available to the next operator.

If you bought this vehicle used, be sure to send in the "Notice of Purchase of Used Car" found in the Service and Warranty Information Booklet, or call the Mercedes-Benz Customer Assistance Center (in the USA) at 1-800-FOR-MERCEdes, or Customer Service (in Canada) at 1-800-387-0100.

### Operating your vehicle outside the USA or Canada

---

If you plan to operate your vehicle in foreign countries, please be aware that:

- service facilities or replacement parts may not be readily available,
- unleaded gasoline for vehicles with catalytic converters may not be available; the use of leaded fuels will damage the catalysts,
- gasoline may have a considerably lower octane rating, and improper fuel can cause engine damage.

Certain Mercedes-Benz models are available for delivery in Europe under our European Delivery Program. For details, consult your authorized Mercedes-Benz Center or write to:

In the USA:

Mercedes-Benz USA, LLC  
European Delivery Department  
One Mercedes Drive  
Montvale, NJ 07645-0350

In Canada:

Mercedes-Benz Canada, Inc.  
European Delivery Department  
98 Vanderhoof Avenue  
Toronto, Ontario M4G 4C9

## Introduction

### Where to find it

#### ▼ Where to find it

This Operator's Manual is designed to provide comprehensive support information for you, the vehicle operator. For you to find information quickly each section has its own reference color:

#### At a glance

Here you will find an overview of all the controls that can be operated from the driver's seat.

#### Getting started

Here you will find all the information you need for your first drive. You should read this section first if this is your first Mercedes-Benz vehicle or if you are renting or borrowing this vehicle.

#### Safety and Security

Here you will find descriptions of the safety features of your vehicle.

#### Controls in detail

Here you will find detailed information about the equipment installed in your vehicle. This section expands on the "Getting started" section and also describes technical innovations. If you are already familiar with the basic functions of your vehicle, this section will be of particular interest to you.

#### Operation

Here you will find all the information you need for the proper operation of your vehicle.

#### Practical hints

This section provides fast assistance for dealing with problems you may encounter.

#### Technical data

All important technical data for your vehicle can be found in this section.

#### Indexes

The glossary provides explanations of the most important technical terms.

The table of contents and the index are designed to help you find information quickly and easily.

The following publications are part of your vehicle documentation:

- this Operator's Manual
- the Service Booklet

Separate operating instructions will be provided as required depending on the equipment options installed in your vehicle.

## ▼ Symbols

The following symbols are found in this Operator's Manual:

- \* Optional equipment is identified with an asterisk. Since standard equipment varies between models, the descriptions and illustrations in this manual may differ slightly from the actual equipment of your vehicle.

### Warning!



Warning notices draw your attention to hazards that may endanger your health or life, or the health or life of others.



Highlights hazards that may result in damage to your vehicle.



Helpful hints or further information you may find useful.

- ▶ This symbol points to instructions for you to follow.
- ▶ A number of these symbols appearing in succession indicates a multiple-step procedure.
- ▷ Page This symbol tells you where to look for further information on a topic.
- ▷▷ This continuation symbol marks an interrupted procedure which will be continued on the next page.
- > In the glossary of technical terms, this symbol is used to indicate cross-references to term definitions.
- DISPLAY Words appearing in the multi-function display are printed in the type shown here.



## Introduction

### Operating safety

#### ▼ Operating safety

##### Warning!



Work improperly carried out on electronic components and associated software could cause them to cease functioning. Because the vehicle's electronic components are interconnected, any modifications made may produce an undesired effect on other systems. Electronic malfunctions could seriously impair the operating safety of your vehicle.

See an authorized Mercedes-Benz Center for repairs or modifications to electronic components.

Other improper work or modifications on the vehicle could also have a negative impact on the operating safety of the vehicle.

Some safety systems only function while the engine is running. You should therefore never turn off the engine while driving.

##### Warning!



Heavy blows against the vehicle underbody or tires / wheels, for example when running over an obstacle, road debris or a pothole, may cause serious damage and impair the operating safety of your vehicle. If you feel a sudden significant vibration or ride disturbance, or you suspect that damage to your vehicle has occurred, you should turn on your hazard warning flashers, carefully slow down, and drive with caution to an area which is a safe distance from the road.

Inspect the vehicle underbody and tires / wheels for possible damage. If the vehicle appears unsafe, have it towed to the nearest authorized Mercedes-Benz Center or other qualified maintenance or repair facility for further inspection or repairs.

#### Proper use of the vehicle

Proper use of the vehicle requires that you are familiar with the following information and rules:

- the safety precautions in this manual
- the “Technical data” section in this manual
- traffic rules and regulations
- motor vehicle laws and safety standards

##### Warning!



Various warning labels are attached to your vehicle. These warning labels are intended to make you and others aware of various risks. You should not remove any of these warning labels unless explicitly instructed to do so by information on the label itself. Removal of any of these labels may cause you and others to be unaware of certain risks which may result in an accident and/or personal injury.

▼ **Problems with your vehicle**

If you should experience a problem with your vehicle, particularly one that you believe may affect its safe operation, we urge you to immediately contact an authorized Mercedes-Benz Center to have the problem diagnosed and corrected if required. If the matter is not handled to your satisfaction, please discuss the problem with the Mercedes-Benz Center management, or if necessary contact us at one of the following addresses:

In the USA:

Customer Assistance Center  
Mercedes-Benz USA, LLC  
One Mercedes Drive  
Montvale, NJ 07645-0350

In Canada:

Customer Relations Department  
Mercedes-Benz Canada, Inc.  
98 Vanderhoof Avenue  
Toronto, Ontario, M4G 4C9

## Introduction

### Reporting safety defects

#### ▼ Reporting safety defects

For the USA only:

The following text is published as required of manufacturers under Title 49, Code of U.S. Federal Regulations, Part 575 pursuant to the “National Traffic and Motor Vehicle Safety Act of 1966.”

#### Reporting safety defects

---

If you believe that your vehicle has a defect which could cause a crash or could cause injury or death, you should immediately inform the National Highway Traffic Safety Administration (NHTSA) in addition to notifying Mercedes-Benz USA, LLC.

If NHTSA receives similar complaints, it may open an investigation, and if it finds that a safety defect exists in a group of vehicles, it may order a recall and remedy campaign. However, NHTSA cannot become involved in individual problems between you, your dealer, or Mercedes-Benz USA, LLC.

To contact NHTSA, you may either call the Auto Safety Hotline toll-free at 1-888-327-4236 (or 366-0123 in Washington, D.C. area) or write to: NHTSA, U.S. Department of Transportation, Washington, D.C. 20590. You can also obtain other information about motor vehicle safety from the Hotline.



## At a glance

Cockpit

Instrument cluster

Multifunction steering wheel

Center console

Overhead control panel

Door control panel

## At a glance

### Cockpit

#### ▼ Cockpit

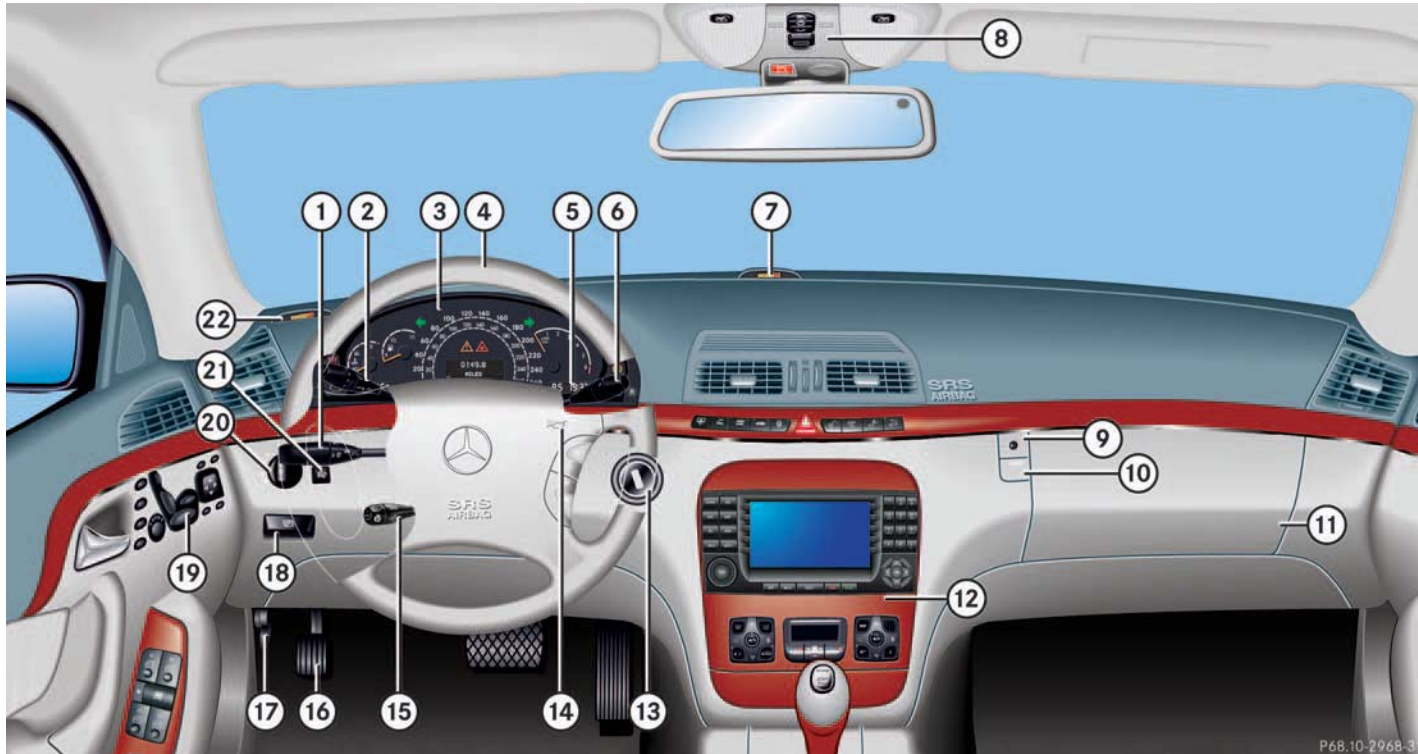

P68.10-2968-31

## At a glance

### Cockpit

	Item	Page
①	Combination switch	
	• Turn signals	47
	• Windshield wipers	48
	• High beam	128
②	Cruise control lever	210
	• Cruise control	203
	• Distronic*	206
③	Instrument cluster	22
④	Multifunction steering wheel	24
⑤	Gear range indicator, clock	22
⑥	Lever for voice control system*, see separate operating instructions	

	Item	Page
⑦	Front Parktronic* (Parking assist) warning indicator for right front area	226
⑧	Overhead control panel	27
⑨	Glove box lock	231
⑩	Glove box lid release	231
⑪	Glove box	231
⑫	Center console	25
⑬	Starter switch	31
⑭	Horn	
⑮	Steering wheel adjustment stalk	37
	Heated steering wheel*	240

	Item	Page
⑯	Parking brake pedal	45
⑰	Hood lock release	272
⑱	Parking brake release	45
⑲	Door control panel	28
⑳	Exterior lamp switch	124
㉑	Headlamp washer button*	177
㉒	Front Parktronic* (Parking assist) warning indicator for left front area	226

## At a glance

### Instrument cluster



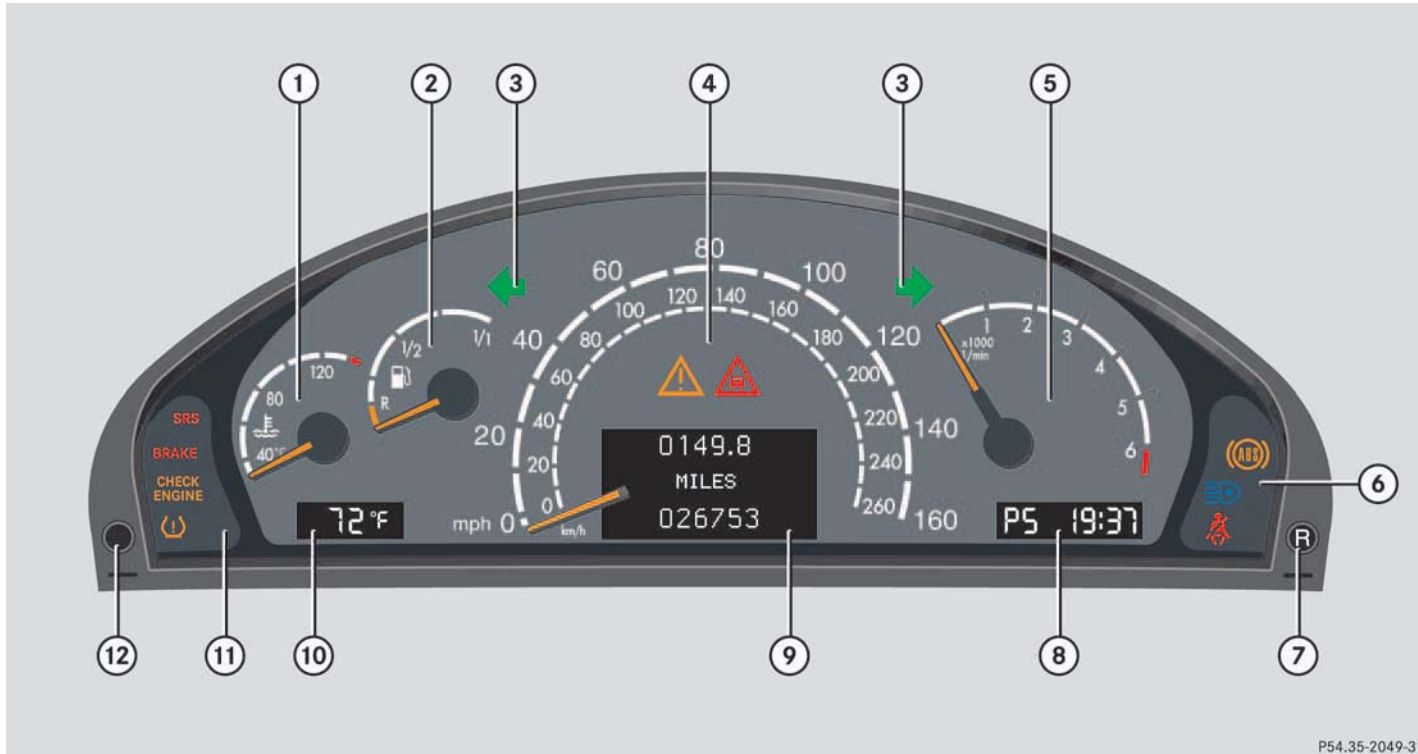

#### ▼ Instrument cluster











P54.35-2049-31

## At a glance

### Instrument cluster

	Item	Page
①	Coolant temperature gauge	132
②	<b>Fuel gauge with:</b>	
	Fuel reserve warning lamp	308
③	 Left turn signal indicator lamp	47
	 Right turn signal indicator lamp	
④	<b>Speedometer with:</b>	
	 ESP warning lamp	308
	 Distance warning lamp	307
	Vehicles without Distronic*: Warning lamp without function. It illuminates when the ignition is on. It should go out when the engine is running.	
⑤	Tachometer	133
⑥	<b>Right display with:</b>	
	 Seat belt telltale	308

	Item	Page
	 High beam headlamp indicator	48
	 Antilock Brake System (ABS) warning lamp	304
⑦	Reset button	131
⑧	<b>Display with:</b>	
	• Program mode	170
	• Gear range indicator	166
	• Digital clock (see COMAND operating instructions)	
⑨	<b>Multifunction display with:</b>	
	• Trip odometer	132
	• Main odometer	132
	Stored speed for:	
	• Cruise control	203
	• Distronic*	206

	Item	Page
⑩	Outside temperature indicator	133
⑪	<b>Left display with:</b>	
	 Supplemental restraint system indicator lamp	310
	 Brake warning lamp, USA only	305
	 Brake warning lamp, Canada only	
	 Engine malfunction indicator lamp, USA only	306
	 Engine malfunction indicator lamp, Canada only	
	 Tire pressure warning lamp	287, 309
⑫	Knob for instrument cluster illumination	131









## At a glance

### Multifunction steering wheel

#### ▼ Multifunction steering wheel



	Item	Page
①	Multifunction display	134
	<b>Operating control system</b>	134
②	Selecting the submenu or setting the volume	135
	<b>+</b> up / to increase	
	<b>-</b> down / to decrease	
③	Telephone*: Press button	144
	 to take a call to dial a call	
	 to end a call to reject an incoming call	

	Item	Page
④	Menu systems: Press button	135
	 for next system	
	 for previous system	
⑤	Moving within a menu: Press button	135
	 for next display	
	 for previous display	

## At a glance

### Center console

#### ▼ Center console

##### Upper part



Item	Page
① Switch for rear window sunshade	179
② Parking assist (Parktronic* system) deactivation switch	227
③ Airmatic or ABC* switch	220
④ Level control switch	222
⑤ Central locking switch	107
Anti-theft alarm system indicator lamp	84
⑥ Hazard warning flasher on/off switch	128
⑦ Central unlocking switch	107
⑧ ESP control switch	80

Item	Page
⑨ Rear seat head restraints, switch for folding down	110
⑩ Tow-away alarm switch	85
⑪ COMAND system (see separate operating instructions)	
⑫ Automatic climate control	194
⑬ Ashtray	238
Lighter	239

## At a glance

### Center console

#### Lower part

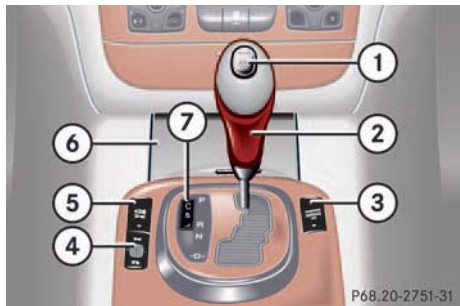

	Item	Page
①	KEYLESS-GO* start / stop button	33
②	Gear selector lever for automatic transmission	43
③	PASSENGER AIRBAG OFF indicator lamp	71
④	Thumbwheel for setting distance in DISTRONIC*	213
⑤	Distance warning function* on / off switch	213
⑥	Lower storage compartments	232
⑦	Program mode selector for automatic transmission	170

▼ Overhead control panel

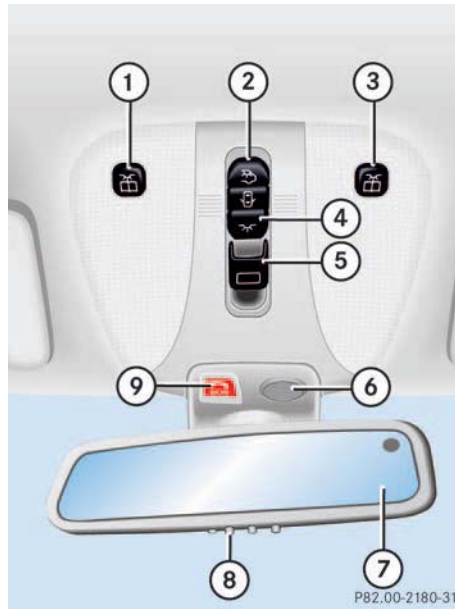

Item	Page
① Left reading lamp on/off	130
② Rear interior lighting on/off	130
③ Right reading lamp on/off	130
④ Interior lighting control	129
⑤ Sliding/pop-up roof	199
⑥ Hands-free microphone for Tele Aid (emergency call system), telephone*, and voice control system* (see separate operating instructions)	242
⑦ Rear view mirror	38
⑧ Garage door opener	250
⑨ Tele Aid (emergency call system) button	245

## At a glance

### Door control panel

#### ▼ Door control panel

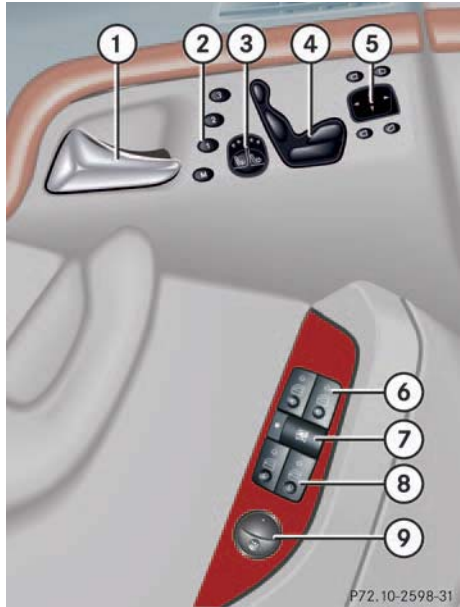

	Item	Page
①	Door handle	96
②	Memory function (for storing seat, exterior mirror, and steering wheel settings)	121
③	Seat heating*	114
	Seat ventilation*	117
④	Seat adjustment	35
⑤	Exterior mirror adjustment	38, 174
⑥	Switches for opening/closing front door windows	195

	Item	Page
⑦	Rear passenger compartment override switch	74
⑧	Switches for opening/closing rear windows	195
⑨	Remote trunk lid release switch	97
	Trunk lid opening/closing system* switch	99

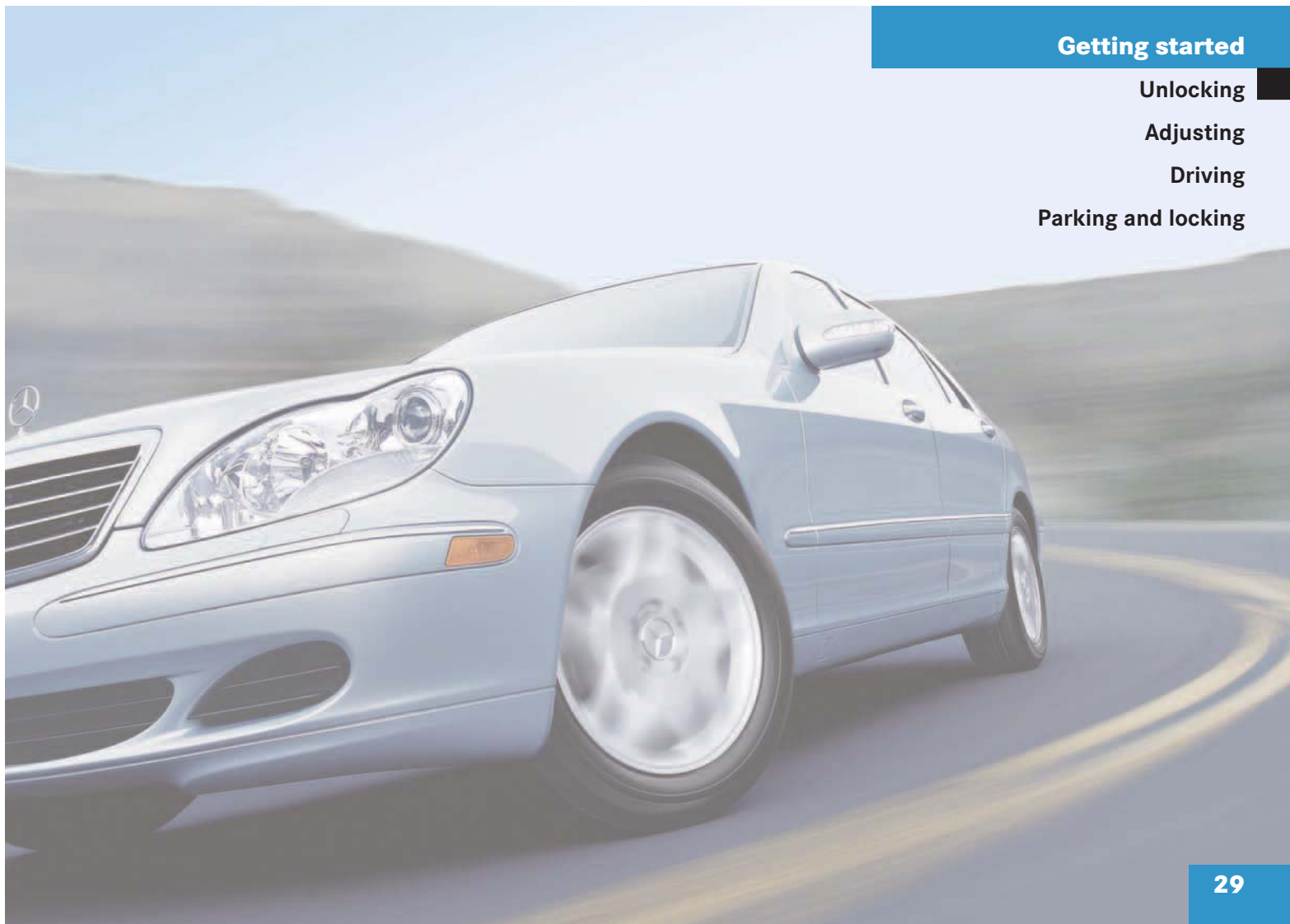

## Getting started

Unlocking

Adjusting

Driving

Parking and locking

## Getting started

### Unlocking

The “Getting started” section provides an overview of the vehicle’s most basic functions. First-time Mercedes-Benz owners should pay special attention to the information given here.



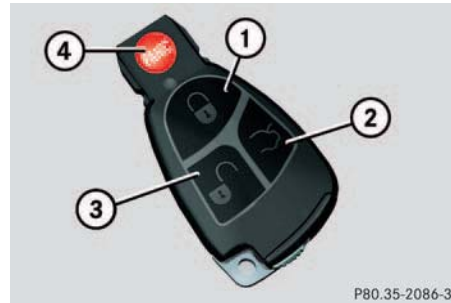

If you are already familiar with the basic functions described here, the “Controls in detail” section will provide you with further information. The corresponding page references are located at the end of each segment.

### ▼ Unlocking

#### Unlocking with the SmartKey



#### SmartKey with remote control

- ①  Lock button
- ②  Unlock button for trunk lid
- ③  Unlock button
- ④  PANIC Panic button

- ▶ Press unlock button  on the SmartKey.

All turn signal lamps flash once. The locking knobs in the doors move up.

- ▶ Get in the vehicle and insert the SmartKey in the starter switch.

For more information, see “Locking and unlocking” (> page 88).

#### Starter switch positions

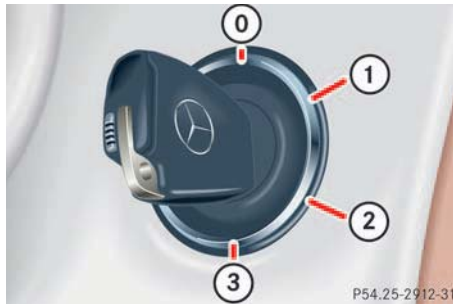

#### Starter switch

- 0** For removing SmartKey
- 1** Power supply to some electrical consumers, such as seat adjustment
- 2** Ignition (power supply for all electrical consumers) and driving position
- 3** Starting position

#### Warning!



When leaving the vehicle, always remove the SmartKey from the starter switch, take the SmartKey with KEYLESS-GO\* with you and lock your vehicle. Do not leave children unattended in the vehicle, or with access to an unlocked vehicle. Unsupervised use of vehicle equipment may cause an accident and/or serious personal injury.



The SmartKey can only be removed from the starter switch with the gear selector lever in position **P**.



If the SmartKey cannot be turned in the starter switch, the battery may not be sufficiently charged.

- ▶ Check the battery and charge it if necessary (▷ page 366).
- ▶ Get a jump start (▷ page 369).

To prevent accelerated battery discharge or a completely discharged battery, always remove the SmartKey from the starter switch when the engine is not in operation.



## Getting started

### Unlocking

#### Unlocking with KEYLESS-GO\*

If your vehicle is equipped with the KEYLESS-GO function, your vehicle checks whether the SmartKey with KEYLESS-GO is valid when you grasp the door handle. If your SmartKey with KEYLESS-GO is valid, the doors will unlock, and you can open them.

The function of the SmartKey overrides the KEYLESS-GO function.



To unlock the vehicle, the SmartKey with KEYLESS-GO must be outside the vehicle, no further than approximately 3 feet (1 meter) away from the door.

- ▶ Grasp the outside door handle.  
All turn signal lamps flash once. The locking knobs in the doors move up.

If the SmartKey is inside the vehicle, pressing the KEYLESS-GO start/stop button on the gear selector lever corresponds to turning the SmartKey to the various starter switch positions.

#### Warning!



When leaving the vehicle, always remove the SmartKey from the starter switch, take the SmartKey with KEYLESS-GO with you and lock your vehicle. Do not leave children unattended in the vehicle, or with access to an unlocked vehicle. Unsupervised use of vehicle equipment may cause an accident and/or serious personal injury.

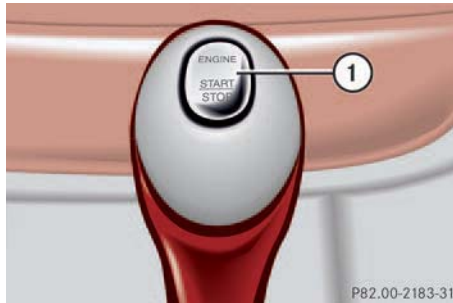

#### ① KEYLESS-GO start/stop button

Before you press the KEYLESS-GO start/stop button ①, the vehicle's on-board electronics have status **0** (as with SmartKey removed).

The SmartKey with KEYLESS-GO must be located in the vehicle.

- ▶ Make sure the gear selector lever is set to **P**.
- ▶ Do not depress the brake pedal.

#### Position 1

- ▶ Press the KEYLESS-GO start/stop button ① once.

This supplies power to some electrical consumers, such as seat adjustment.



If you now press the KEYLESS-GO start/stop button

- once again, the ignition (position **2**) is switched on
- twice, the power supply is again switched off

#### Ignition (or position 2)

- ▶ Press the KEYLESS-GO start/stop button ① twice.

This supplies power to all electrical consumers. All the lamps in the instrument cluster come on.



If you now press the KEYLESS-GO start/stop button once, the power supply is again switched off.

For more information, see “SmartKey with KEYLESS-GO\*” (▷ page 91).

For information on starting the engine using the KEYLESS-GO start/stop button, see “Starting with KEYLESS-GO\*” (▷ page 44).

## Getting started

### Adjusting

#### ▼ Adjusting

##### Warning!



All seat, head restraint, steering wheel, and rear view mirror adjustments, as well as fastening of seat belts, must be done before the vehicle is put into motion.

#### Seats

##### Warning!



Do not adjust the driver's seat while driving. Adjusting the seat while driving could cause the driver to lose control of the vehicle.

Never ride in a moving vehicle with the seat back in an excessively reclined position as this can be dangerous. You could slide under the seat belt in a collision. If you slide under it, the belt would apply force at the abdomen or neck. That could cause serious or fatal injuries. The seat backrest and seat belts provide the best restraint when the wearer is in a nearly upright position and belts are properly positioned on the body.

Your seat must be adjusted so that you can correctly fasten your seat belt (▷ page 40).

Never place hands under the seat or near any moving parts while a seat is being adjusted.

##### Warning!



When leaving the vehicle, always remove the SmartKey from the starter switch, take the SmartKey with KEYLESS-GO\* with you, and lock your vehicle.

Even with the SmartKey removed from the starter switch or the SmartKey with KEYLESS-GO\* removed from the vehicle, the power seats can be operated when the respective door is open. Therefore, do not leave children unattended in the vehicle, or with access to an unlocked vehicle. Unsupervised use of vehicle equipment may cause an accident and/or serious personal injury.

##### Warning!



Children 12 years old and under must never ride in the front seat, except in a Mercedes-Benz authorized BabySmart™ compatible child seat, which operates with the BabySmart™ system installed in the vehicle to deactivate the passenger front airbag when it is properly installed. Otherwise they will be struck by the airbag when it inflates in a crash. If this happens, serious or fatal injury will result.

According to accident statistics, children are safer when properly restrained in the rear seating positions than in the front seating positions. Infants and small children must ride in back seats and be seated in an appropriate infant or child restraint system, which is properly secured with the vehicle's seat belt and top tether strap, or secured via lower anchors and top tether strap, fully in accordance with the child seat manufacturer's instructions.

A child's risk of serious or fatal injuries is significantly increased if the child restraints are not properly secured in the vehicle and the child is not properly secured in the child restraint.

### Seat adjustment

The seat adjustment switches are located on the front doors.

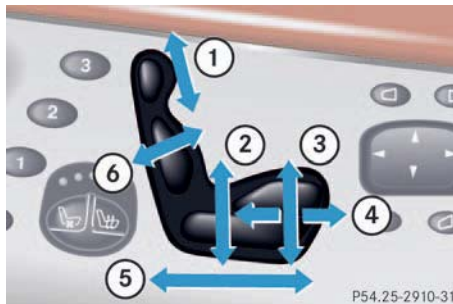

- ① Head restraint height
- ② Seat height
- ③ Seat cushion tilt
- ④ Seat cushion depth
- ⑤ Seat fore and aft adjustment
- ⑥ Seat backrest tilt

- ▶ Switch on ignition.
- or
- ▶ Open the respective door.

### Seat fore and aft adjustment

- ▶ Press the switch forward or backward in the direction of arrow ⑤.

Adjust seat to a comfortable seating position that still allows you to reach the accelerator / brake pedal safely. The position should be as far to the rear as possible, consistent with ability to properly operate controls.



When moving the seat, make sure there are no items in the footwell or behind the seats. Otherwise you could damage the seats.

The memory function (▷ page 121) lets you store the setting for the seat position together with the settings for the steering wheel and the exterior rear view mirrors.

### Seat cushion tilt

- ▶ Press the switch up or down in the direction of arrow ③ until your upper legs are lightly supported.

### Seat cushion depth

- ▶ Press the switch forward or backward in the direction of arrow ④ until your legs are supported comfortably.

### Seat backrest tilt

- ▶ Press the switch forward or backward in the direction of arrow ⑥ until your arms are slightly angled when holding the steering wheel.

### Seat height

- ▶ Press the switch up or down in the direction of arrow ②.

## Getting started

### Adjusting

#### Head restraint height

- ▶ Press the switch up or down in the direction of arrow ①.

#### Warning!



For your protection, drive only with properly positioned head restraints.

Adjust head restraint so that the center of the head restraint supports the back of the head at eye level. This will reduce the potential for injury to the head and neck in the event of an accident or similar situation.

Do not drive the vehicle without the seat head restraints. Head restraints are intended to help reduce injuries during an accident.

#### Head restraint tilt



Manually adjust the angle of the head restraint.

- ▶ Push or pull on the lower edge of the head restraint cushion.



The feature below is deactivated at the factory. If you wish to have it activated, contact an authorized Mercedes-Benz Center:

The front passenger seat head restraint automatically lowers after a few seconds when the front passenger seat is not occupied. This improves the driver's outward view as well as the forward view from the rear passenger compartment.

When the front passenger seat is occupied again, the front passenger seat head restraint returns to the last set position within a few seconds.

If the front passenger seat was moved fore or aft while not being occupied, the front passenger seat head restraint returns to a position that corresponds best with the seat's axial position when the seat is occupied again.

For more information, see "Seats" (▷ page 108).

## Steering wheel

### Warning!



Do not adjust the steering wheel while driving. Adjusting the steering wheel while driving could cause the driver to lose control of the vehicle.

When leaving the vehicle, always remove the SmartKey from the starter switch, take the SmartKey with KEYLESS-GO\* with you and lock your vehicle.

Even with the SmartKey removed from the starter switch or the SmartKey with KEYLESS-GO\* removed from the vehicle, the steering wheel adjustment feature can be operated when the driver's door is open. Therefore, do not leave children unattended in the vehicle, or with access to an unlocked vehicle. Unsupervised use of vehicle equipment may cause an accident and/or serious personal injury.

## Steering wheel adjustment

The stalk for steering wheel adjustment is located on the steering column (lower left).



- ① Adjusting steering column, in or out
- ② Adjusting steering column, up or down

- ▶ Switch on ignition.
- or
- ▶ Open the driver's door.

## Getting started

### Adjusting

#### Adjusting steering column in or out

- ▶ Move stalk forward or back in the direction of arrow ① until a comfortable steering wheel position is reached with your arms slightly bent at the elbow.

#### Adjusting steering column up or down

- ▶ Move the stalk up or down in the direction of arrow ②.

Make sure your legs can move freely and all the displays (incl. malfunction and indicator lamps) on the instrument cluster are clearly visible.



The memory function (▷ page 121) lets you store settings for the steering wheel together with the settings for the exterior rear view mirrors and the seat position.

For more information, see “Heated steering wheel\*” (▷ page 240).

## Getting started

### Adjusting

#### Mirrors

Adjust the interior and exterior rear view mirrors before driving so that you have a good view of the road and traffic conditions.

#### Warning!



In the case of an accident, liquid electrolyte may escape the mirror housing if the mirror glass breaks.

Electrolyte has an irritating effect. Do not allow the liquid to come into contact with eyes, skin, clothing, or respiratory system. In case it does, immediately flush affected area with water, and seek medical help if necessary.

#### Interior rear view mirror

- ▶ Manually adjust the interior rear view mirror.



Electrolyte drops coming into contact with the vehicle paint finish can only be completely removed while in their liquid state and by applying plenty of water.

For more information, see “Rear view mirror” (▷ page 174).

#### Exterior rear view mirror

#### Warning!



Exercise care when using the passenger side exterior rear view mirror. The mirror surface is convex (outwardly curved surface for a wider field of view). Objects in mirror are closer than they appear. Check your interior rear view mirror or glance over your shoulder before changing lanes.

The buttons are located on the driver's door.

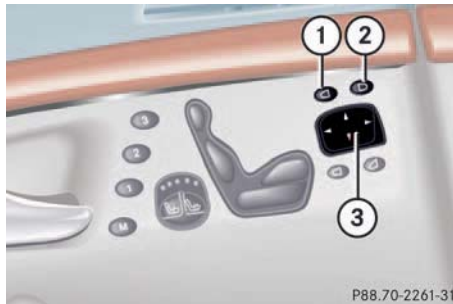

- ① Driver's side exterior rear view mirror button
- ② Passenger-side exterior rear view mirror button
- ③ Adjustment button

- ▶ Switch on ignition.
- ▶ Press button ① for the left mirror or button ② for the right mirror.
- ▶ Push adjustment button ③ up, down, left, or right according to the desired setting.



For information on how to reposition the exterior mirror housing when it was forcibly pushed forward (hit from the rear) or forcibly pushed rearward (hit from the front), see "Folding the exterior mirrors in and out manually" (> page 176).



The memory function (> page 121) lets you store the setting for the exterior rear view mirrors together with the setting for the steering wheel and the seat position.

At low ambient temperatures, the mirrors will be heated automatically.

For more information, see "Folding the exterior mirrors in and out automatically" (> page 176).



## Getting started

### Driving

#### ▼ Driving

##### Warning!



Do not lay any objects in the driver's footwell. Be careful that floor mats or carpets in the driver's footwell have sufficient clearance for the pedals.

During sudden driving or braking maneuvers the objects could get caught between the pedals. You could then no longer brake or accelerate.

#### Fastening the seat belts

##### Warning!



Always fasten your seat belt before driving off. Always make sure your passengers are properly restrained, even those sitting in the rear and pregnant women.

Failure to wear and properly fasten and position your seat belt greatly increases your risk of injuries and their likely severity in an accident. You and your passengers should always wear seat belts.

If you are ever in an accident, your injuries can be considerably more severe without your seat belt properly buckled. Without your seat belt buckled, you are much more likely to hit the interior of the vehicle or be ejected from it. You can be seriously injured or killed.

In the same crash, the possibility of injury or death is lessened if you are wearing your seat belt. The airbags can only provide the protection they were designed to afford if the occupants are using their seat belts (▷ page 58).

##### Warning!



Children 12 years old and under must never ride in the front seat, except in a Mercedes-Benz authorized BabySmart<sup>TM</sup><sup>1</sup> compatible child seat, which operates with the BabySmart<sup>TM</sup> system installed in the vehicle to deactivate the passenger front airbag when it is properly installed. Otherwise they will be struck by the airbag when it inflates in a crash. If this happens, serious or fatal injury will result.

<sup>1</sup> BabySmart<sup>TM</sup> is a trademark of Siemens Automotive Corp.

According to accident statistics, children are safer when properly restrained in the rear seating positions than in the front seating positions. Infants and small children must ride in back seats and be seated in an appropriate infant or child restraint system, which is properly secured with the vehicle's seat belt and top tether strap, or secured via lower anchors and top tether strap, fully in accordance with the child seat manufacturer's instructions.

A child's risk of serious or fatal injuries is significantly increased if the child restraints are not properly secured in the vehicle and the child is not properly secured in the child restraint.

**Warning!**



Never let more people ride in the vehicle than there are seat belts available. Be sure everyone riding in the vehicle is correctly restrained with a separate seat belt. Never use a seat belt for more than one person at a time.

**Warning!**



Never ride in a moving vehicle with the seat backrest in an excessively reclined position as this can be dangerous. You could slide under the seat belt in a collision. If you slide under it, the belt would apply force at the abdomen or neck. That could cause serious or even fatal injuries. The seat backrest and seat belt provide the best restraint when the wearer is in a nearly upright position and the belt is properly positioned on the body.

## Getting started

### Driving

**Warning!**



Read and observe the additional warning notices printed in the "Safety and Security" section (▷ page 62).

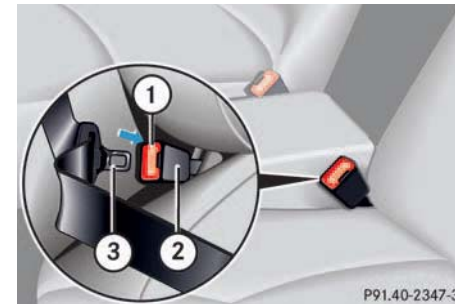

- ① Release button
- ② Buckle
- ③ Latch plate

- ▶ Pull the seat belt smoothly from the seat belt outlet.



## Getting started

### Driving

- ▷▷▶ Place the shoulder portion of the belt across the top of your shoulder and the lap portion across your hips.
- ▶ Push latch plate ③ into buckle ② until it clicks.
- ▶ If necessary, tighten the lap portion to a snug fit by pulling shoulder portion up.

#### Proper use of seat belts

- Do not twist the belt when fastening.
- Adjust seat belt so that the shoulder portion is located as close as possible to the middle of the shoulder (it should not touch the neck). Never pass the shoulder portion of the belt under your arm.
- Position the lap belt as low as possible on your hips (over hip joint) and not across the abdomen.
- Place the seat backrest in a nearly upright position.
- Never use a seat belt for more than one person at a time.
- Do not fasten a seat belt around a person and another object at the same time.
- Check your seat belt during travel to make sure that it is properly positioned.
- Make sure that the seat belt is always fitted snugly. Take special care of this when wearing loose clothing.

#### Warning!



Do not pass belts over sharp edges. They could tear.

Do not allow the belt to get caught in the door or in the seat adjustment mechanism. This could damage the belt.

Never attempt to make modifications to seat belts. This could impair the effectiveness of the belts.

Do not bleach or dye seat belts as this may severely weaken them. In a crash, they may not be able to provide adequate protection.

Damaged seat belts or belts that were highly stressed in an accident must be replaced. Contact an authorized Mercedes-Benz Center.

## Starting the engine

### Warning!



Inhalation of exhaust gas is hazardous to your health. All exhaust gas contains carbon monoxide, and inhaling it can cause unconsciousness and lead to death.

Do not run the engine in confined areas (such as a garage) which are not properly ventilated. If you think that exhaust gas fumes are entering the vehicle while driving, have the cause determined and corrected immediately. If you must drive under these conditions, drive with at least one window fully open.

## Automatic transmission

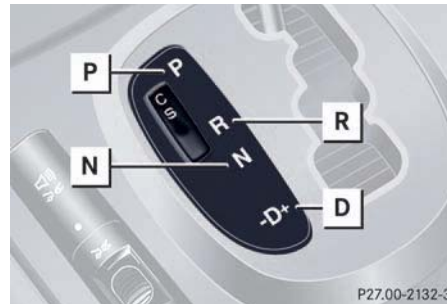

### Gearshift pattern for automatic transmission

- P** Park position with gear selector lever lock
- R** Reverse gear
- N** Neutral
- D** Drive position

For more information, see the “Controls in detail” section (▷ page 164).

## Starting with the SmartKey

- ▶ Make sure the gear selector lever is set to **P**.
- ▶ Do not depress accelerator.
- ▶ Turn the SmartKey in the starter switch to position **3** and hold until the engine starts (▷ page 31).



You can also use the “touch-start” function. Turn the SmartKey to position **3** and release it again immediately. The engine then starts automatically.

- ▶ Depress the brake pedal.

The gear selector lever lock is released.

For information on turning off the engine with the SmartKey, see “Turning off with the SmartKey” (▷ page 53).

## Getting started

### Driving

#### Starting with KEYLESS-GO\*

You can start your vehicle without the SmartKey in the starter switch using the KEYLESS-GO start/stop button on the gear selector lever.

The SmartKey with KEYLESS-GO must be located in the vehicle.

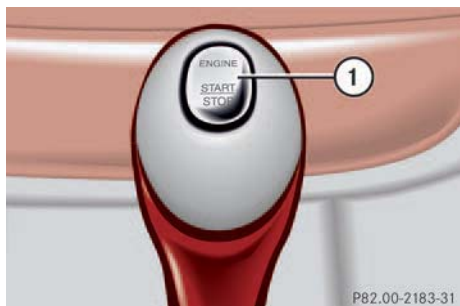

① KEYLESS-GO start/stop button

- ▶ Make sure the gear selector lever is set to **P**.
- ▶ Depress the brake pedal during the starting procedure. Do not depress accelerator.

The gear selector lever lock is released.

- ▶ Press KEYLESS-GO start/stop button ① once.

The engine starts automatically if the SmartKey with KEYLESS-GO is in the vehicle .

For information on turning off the engine with KEYLESS-GO, see “Turning off the engine with KEYLESS-GO\*” (▷ page 54).

#### Starting difficulties

If the engine does not start as described, carry out the following steps:

- ▶ If you are starting the engine with the SmartKey, turn SmartKey in starter switch to position **0** and repeat starting procedure.
- ▶ If you are starting the engine with KEYLESS-GO: Close any doors that may be open to allow for better detection of the SmartKey with KEYLESS-GO.  
or:  
Start the engine with the SmartKey as radio signals from another source may be interfering with the SmartKey with KEYLESS-GO.

- ▶ Repeat the starting procedure (▷ page 43). Remember that extended starting attempts can drain the battery.

- ▶ Get a jump start (▷ page 369).

If the engine does not start after several starting attempts, there could be a malfunction in the engine electronics or in the fuel supply system.

- ▶ Notify an authorized Mercedes-Benz Center.

#### Parking brake



- ① Parking brake pedal
- ② Parking brake release handle

## Getting started

### Driving

#### Warning!



When leaving the vehicle, always remove the SmartKey from the starter switch, take the SmartKey with KEYLESS-GO\* with you and lock your vehicle. Do not leave children unattended in the vehicle, or with access to an unlocked vehicle. Children could release the parking brake, which could result in an accident and/or serious injury.

- ▶ Release the parking brake by pulling handle ②.

The indicator lamp **BRAKE** (USA only) or **(P)** (Canada only) in the instrument cluster goes out.

## Getting started

### Driving

#### Driving

- ▶ Depress the brake pedal.
- ▶ Move gear selector lever to position **D** or **R**.

#### Warning!



It is dangerous to shift the gear selector lever out of **P** or **N** if the engine speed is higher than idle speed. If your foot is not firmly on the brake pedal, the vehicle could accelerate quickly forward or in reverse. You could lose control of the vehicle and hit someone or something. Only shift into gear when the engine is idling normally and when your right foot is firmly on the brake pedal.

#### Warning!



On slippery road surfaces, never downshift in order to obtain braking action. This could result in drive wheel slip and reduced vehicle control. Your vehicle's ABS will not prevent this type of loss of control.



In order to avoid damaging the transmission,

- wait for the gear selection process to complete before setting the vehicle in motion.
  - place the gear selector lever in position **R** only when the vehicle is stopped.
- ▶ Release the brake pedal.
  - ▶ Carefully depress the accelerator pedal.

Once the vehicle is in motion, the automatic central locking system engages and the locking knobs drop down.



If you hear a warning signal and a message appears in the multifunction display when driving off, you have forgotten to release the parking brake.

Release the parking brake.

After a cold start, the automatic transmission shifts at a higher engine revolution. This allows the catalytic converter to reach its operating temperature earlier.



Do not run cold engine at high engine speeds. Running a cold engine at high engine speeds may shorten the service life of the engine.



Simultaneously depressing the accelerator pedal and applying the brake reduces engine performance and causes premature brake and drivetrain wear.



You can open a locked door from the inside. Open doors only when conditions are safe to do so.

You can deactivate the automatic locking using the control system (▷ page 159).

For more information, see “Driving instructions” (▷ page 259).

### Switching on headlamps



#### Exterior lamp switch

- ① Off
- ② Low beam headlamps on

► Turn the switch to .

For more information, see “Exterior lamp switch” (▷ page 124).

## Getting started

### Driving

### Turn signals and high beam

The combination switch is located on the left of the steering column.



#### Combination switch

- ① Turn signals, right
- ② Turn signals, left

► Press the combination switch up ① or down ②.



To signal minor directional changes, move combination switch to point of resistance only and release. The turn signal flashes three times.



## Getting started

### Driving

#### High beam

- ▶ Push the combination switch forward.  
The high beam headlamps are switched on.  
The high beam headlamp indicator  in the tachometer comes on.

For more information, see “High beam flasher” (▶ page 128).

#### Windshield wipers

The combination switch is located on the left of the steering column.



#### Combination switch

- ① Single wipe
  - ② Switching on windshield wipers
- ▶ Make sure the ignition is switched on.  
All the lamps in the instrument cluster come on.

#### Switching on windshield wipers

- ▶ Turn the combination switch to the desired position depending on the intensity of the rain.

- 0 Windshield wipers off
- I Intermittent wiping (interval dependent on wetness of windshield)
- II Normal wiper speed
- III Fast wiper speed

#### i

The intermittent wiping interval is dependent on wetness of windshield. Wiping will not occur with a door open.



Do not leave windshield wipers in intermittent setting when vehicle is taken to an automatic car wash or during windshield cleaning. Wipers will operate in the presence of water sprayed on the windshield, and wipers may be damaged as a result.

The switch should not be left in intermittent setting as the wipers will wipe the windshield once every time the engine is started. Dust that accumulates on the windshield might scratch the glass and/or damage the wiper blades when wiping occurs on a dry windshield.

#### Single wipe

- ▶ Press switch briefly in the direction of arrow ①.

The windshield wipers wipe one time without washer fluid.

#### Wiping with windshield washer fluid

- ▶ Press switch in the direction of arrow ① past the resistance point. The windshield wiper operates with washer fluid.

For information on filling up the washer reservoir, see “Windshield washer system and headlamp cleaning system\*” (▷ page 281).



If anything blocks the windshield wipers (leaves, snow, etc.), switch them off immediately.

- For safety reasons,
  - turn off the engine by turning the SmartKey to position **0** and withdraw SmartKey from starter switch

or

- turn off the engine by pressing the KEYLESS-GO\* start/stop button and open the driver’s door (with the driver’s door open, starter switch is in position **0**, same as with SmartKey removed from starter switch)

before attempting to remove any blockage.

- Remove blockage.
- Turn the windshield wipers on again.

If windshield wipers fail to function at all in switch position **I**,

- set the combination switch to the next highest wiper speed
- have the windshield wipers checked at the nearest authorized Mercedes-Benz Center

## Getting started

### Driving

#### Problems while driving

##### The engine runs erratically and misfires

- An ignition cable may be damaged.
- The engine electronics may not be operating properly.
- Unburned gasoline may have entered the catalytic converter and damaged it.
- ▶ Give very little gas.
- ▶ Have the problem repaired by an authorized Mercedes-Benz Center as soon as possible.

##### The coolant temperature is above 248°F (120°C)

The coolant is too hot and is no longer cooling the engine.

- ▶ Stop the vehicle as soon as possible and turn off the engine. Allow engine and coolant to cool.
- ▶ Check the coolant level and add coolant if necessary (▷ page 278).



Excessive coolant temperatures trigger a warning message in the multifunction display (▷ page 323).

##### In case of accident

If the vehicle is leaking gasoline:

- ▶ Do not start the engine under any circumstances.
- ▶ Notify local fire and/or police authorities.

If the extent of the damage cannot be determined:

- ▶ Notify an authorized Mercedes-Benz Center.

If no damage can be determined on the

- major assemblies
- fuel system
- engine mount:
- ▶ Start the engine in the usual manner.

## ▼ Parking and locking

You have now completed your first drive. You have properly stopped and parked your vehicle. End your drive as follows.

### Warning!



Wait until the vehicle is stationary before removing the SmartKey from the starter switch. The vehicle cannot be steered when the SmartKey is removed.

### Warning!



With the engine not running, there is no power assistance for the brake and the steering systems. In this case, it is important to keep in mind that a considerably higher degree of effort is necessary to brake and steer the vehicle.

### Warning!



Do not park this vehicle in areas where combustible materials such as grass, hay, or leaves can come into contact with the hot exhaust system, as these materials could be ignited and cause a vehicle fire.

To reduce the risk of personal injury as a result of vehicle movement, before turning off the engine and leaving the vehicle always:

- Keep right foot on brake pedal.
- Firmly depress parking brake pedal.
- Move the gear selector lever to position **P**.
- Slowly release brake pedal.
- When parked on an incline, turn front wheel towards the road curb.

## Getting started

### Parking and locking

- Turn the SmartKey to starter switch position **0** and remove, or press start / stop button (vehicles with KEYLESS-GO\*).
- Take the SmartKey or the SmartKey with KEYLESS-GO\* and lock vehicle when leaving.

## Getting started

### Parking and locking

#### Parking brake



- ① Parking brake
- ② Release handle

- ▶ Step firmly on parking brake ①.

When the engine is running, the indicator lamp **BRAKE** (USA only) or **(P)** (Canada only) in the instrument cluster illuminates.

#### Warning!



When leaving the vehicle, always remove the SmartKey from the starter switch, take the SmartKey with KEYLESS-GO\* with you and lock your vehicle. Do not leave children unattended in the vehicle, or with access to an unlocked vehicle. Children could release the parking brake and/or move the gear selector lever from position **P**, either of which could result in an accident and/or serious injury.

#### Warning!



Getting out of your vehicle with the gear selector lever not fully engaged in position **P** is dangerous. Also, when parked on an incline, position **P** alone may not prevent your vehicle from moving, possibly hitting people or objects.

Always set the parking brake in addition to shifting to position **P** (▷ page 166).

When parked on an incline, turn front wheels towards the road curb.

### Switching off headlamps

- ▶ Turn the exterior lamp switch to **0**.  
For more information, see “Lighting” (▷ page 124).

### Turning off the engine

- ▶ Place the gear selector lever in position **P**.



Always set the parking brake in addition to shifting to position **P**.  
On steep slopes, turn the front wheels towards the curb.

### Turning off with the SmartKey

- ▶ Turn the SmartKey in the starter switch (▷ page 31) to position **0** and remove it.  
The immobilizer is activated.



The SmartKey can only be removed from the starter switch with the gear selector lever in position **P**.

- ▶ Press the seat belt release button (▷ page 41).

Allow the retractor to completely re-wind the seat belt by guiding the latch plate.



With the SmartKey removed and the driver’s door open, a warning sounds if the vehicle’s exterior lamps are not switched off.

## Getting started

### Parking and locking

#### Warning!



To prevent possible personal injury, always keep hands and fingers away from the door openings when closing the doors. Be especially careful when small children are around.

Before closing doors, make sure there is no possibility of someone getting caught in a door during closing.

- ▶ After exiting the vehicle press the lock button  on the SmartKey (▷ page 30).

All turn signal lamps flash three times. The locking knobs on the doors move down.

## Getting started

### Parking and locking

#### Warning!



When leaving the vehicle, always remove the SmartKey from the starter switch and lock your vehicle. Do not leave children unattended in the vehicle, or with access to an unlocked vehicle. Unsupervised use of vehicle equipment may cause an accident and/or serious injury.

For more information, see “Locking and unlocking” (▷ page 88).

#### Turning off the engine with KEYLESS-GO\*

- ▶ Place the gear selector lever in position **P**.
- ▶ Press the KEYLESS-GO start/stop button to shut off the engine.

With the driver's door closed, the starter switch is now in position **1**. With the driver's door opened, the starter switch is set to position **0**, same as SmartKey removed from starter switch (▷ page 31).

- ▶ Press the seat belt release button (▷ page 41).

Allow the retractor to completely rewind the seat belt by guiding the latch plate.



If you hear a warning signal, you have either

- forgotten to turn off the lights before opening the driver's door
- or
- tried to turn off the engine while the gear selector lever is not in **P**.

Turn off the lights or place the gear selector lever in **P**.

#### Warning!



To prevent possible personal injury, always keep hands and fingers away from the door openings when closing the doors. Be especially careful when small children are around.

Before closing doors, make sure there is no possibility of someone getting caught in a door during closing.

## Getting started

### Parking and locking

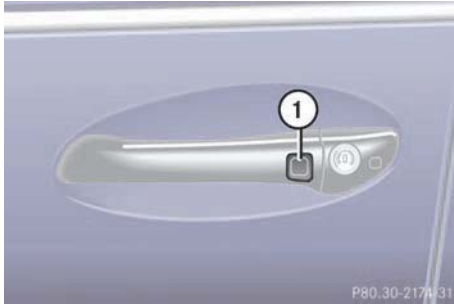

① Lock button on the door handle

- ▶ After exiting the vehicle, press lock button ① on the door handle or on the trunk lid.

All turn signal lamps flash three times. The locking knobs on the doors move down.

#### Warning!



When leaving the vehicle, always remove the SmartKey from the starter switch, take the SmartKey with KEYLESS-GO\* with you, and lock your vehicle. Do not leave children unattended in the vehicle, or with access to an unlocked vehicle. Unsupervised use of vehicle equipment may cause an accident and/or serious personal injury.

For more information, see “Locking and unlocking” (▷ page 88).





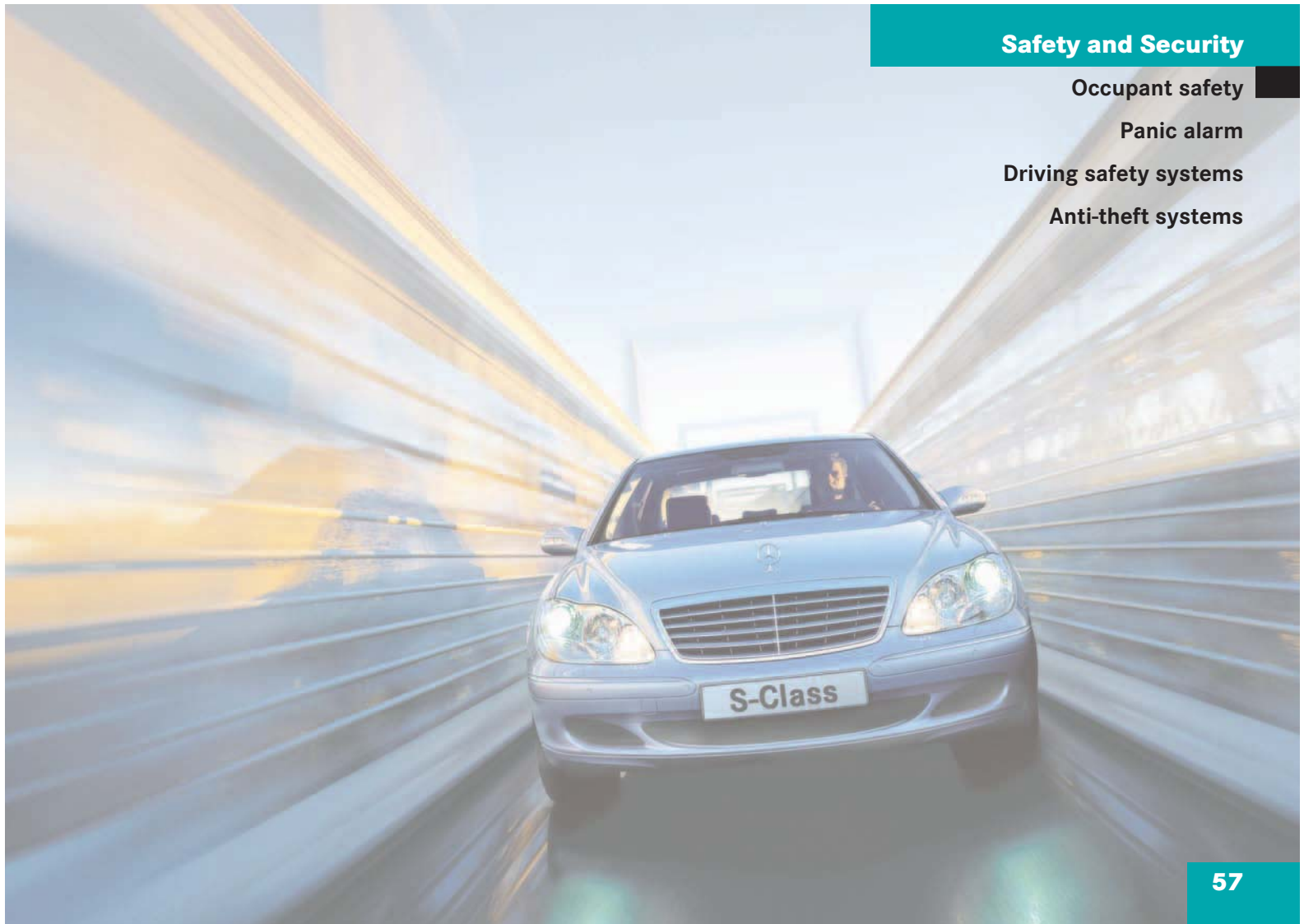

## **Safety and Security**

**Occupant safety**

**Panic alarm**

**Driving safety systems**

**Anti-theft systems**

## Safety and Security

### Occupant safety

#### ▼ Occupant safety

In this section you will learn the most important facts about the restraint systems of the vehicle.

The restraint systems are:

- Seat belts
- Emergency tensioning device
- Airbags
- Child seats
- Child seat recognition
- Lower anchors and tethers for children (LATCH)

As independent systems, their protective effects work in conjunction with each other.



For information on infants and children traveling with you in the vehicle and restraint systems for infants and children, see “Children in the vehicle” (▷ page 69).

The **SRS** indicator lamp in the instrument cluster comes on

- for about four seconds when you turn the SmartKey in the starter switch to position **1** or press the KEYLESS-GO\* start/stop button once. It then goes out briefly, comes on again and remains lit until you start the engine.
- for about four seconds when you start the engine by turning the SmartKey or pressing the KEYLESS-GO\* start/stop button.



The **SRS** indicator lamp remains lit if the SmartKey is turned to position **2** and left there or the KEYLESS-GO\* start/stop button is pressed twice. The indicator lamp will go out when you start the engine.

The restraint systems are fully operational if the **SRS** indicator lamp is not lit when the engine is running.

A malfunction in the system has been detected if the **SRS** indicator lamp:

- fails to extinguish after approximately four seconds.
- does not come on at all.
- comes on after the engine was started or while driving.

For safety reasons, we strongly recommend that you visit an authorized Mercedes-Benz Center immediately to have the system checked.

For more information, see “Practical hints” (▷ page 303).

#### Warning!



In the event that the **SRS** indicator lamp comes on during driving or does not come on at all, the SRS self-check has detected a malfunction. For your safety, we strongly recommend that you visit an authorized Mercedes-Benz Center immediately to have the system checked; otherwise the SRS may not be activated when needed in an accident, which could result in serious or fatal injury, or it might deploy unexpectedly and unnecessarily which could also result in injury.

In addition, improper repair work on the SRS creates a risk of rendering the SRS inoperative or causing unintended airbag deployment. Work on the SRS must therefore only be performed by qualified technicians. Contact an authorized Mercedes-Benz Center.

#### Airbags

#### Warning!



Airbags are designed to reduce the potential of injury and fatality in certain frontal impacts (front airbags), side impacts (side impact airbags and head protection window curtain airbags) or rollovers (head protection window curtain airbags). However, no system available today can totally eliminate injuries and fatalities.

The activation of the airbags temporarily releases a small amount of dust from the airbags. This dust, however, is neither injurious to your health, nor does it indicate a fire in the vehicle. The dust might cause some temporary breathing difficulty for people with asthma or other breathing trouble. To avoid this, you may wish to get out of the vehicle as soon as it is safe to do so. If you have any breathing difficulty but cannot get out of the vehicle after the airbag inflates, then get fresh air by opening a window or door.

#### Warning!



To reduce the risk of injury when the front airbags inflate, it is very important for the driver and passenger front to always be in a properly seated position and to wear your seat belts.

For maximum protection in the event of a collision always be in normal seated position with your back against the seat backrest. Fasten your seat belt and ensure that it is properly positioned on your body.

Since the airbag inflates with considerable speed and force, a proper seating and hands on steering wheel position will help to keep you at a safe distance from the airbag. Occupants who are unbelted, out of position or too close to the airbag can be seriously injured by an airbag as it inflates with great force in the blink of an eye:

- Sit properly belted in a nearly upright position with your back against the seat backrest.



## Safety and Security

### Occupant safety



- Adjust the driver seat as far as possible rearward, still permitting proper operation of vehicle controls. The distance from the center of the driver's breastbone to the center of the airbag cover on the steering wheel must be at least 10 in (25 cm) or more. You should be able to accomplish this by a combination of adjustments to the seat and steering wheel. If you have any problems, please see an authorized Mercedes-Benz Center.
- Do not lean with your head or chest close to the steering wheel or dashboard.
- Keep hands on the outside of steering wheel rim. Placing hands and arms inside the rim can increase the risk and potential severity of hand/arm injury when driver front airbag inflates.
- Adjust the front passenger seat as far as possible rearward from the dashboard when the seat is occupied.
- Occupants, especially children, should never lean their heads in the area of the door where the side airbag inflates.

This could result in serious injuries or death should the airbag be triggered. Always sit nearly upright, properly use the seat belts and appropriate size infant or child restraint system.

- Children 12 years old and under must never ride in the front seat, except in a Mercedes-Benz authorized BabySmart™ compatible child seat, which operates with the BabySmart™ system installed in the vehicle to deactivate the passenger front airbag when it is properly installed. Otherwise they will be struck by the airbag when it inflates in a crash. If this happens, serious or fatal injury will result.

Failure to follow these instructions can result in severe injuries to you or other occupants.

If you sell your vehicle, it is extremely important that you make the buyer aware of this safety information. Be sure to give the buyer this Operator's Manual.

### Warning!



Accident research shows that the safest place for children in an automobile is in the rear seat. Should you choose to place a child 12 years old or under in the front passenger seat of your vehicle, you must properly use a BabySmart™ child restraint which will turn off the passenger front airbag. BabySmart™ will not, however, turn off any side impact airbag.

It should be noted that with respect to both front and rear side impact airbags there is a possibility for a side airbag related injury if occupants, especially children, are not properly seated or restrained when next to a side airbag which needs to deploy rapidly in a side impact in order to do its job.

To help avoid the possibility of injury, please follow these guidelines:

- (1) Occupants, especially children, should never place their bodies or lean their heads in the area of the door where the side airbag inflates. This could result in

## Safety and Security

### Occupant safety

serious injuries or death should the side airbag be activated.

- (2) Always sit nearly upright, properly use the seat belts and use an appropriately sized infant or child restraint system for all children 12 years old or under.
- (3) Always wear seat belts properly.

If you believe that, even with the use of these guidelines, it would be safer for your rear seat occupants to have the rear mounted side airbags deactivated, then deactivation can be accomplished upon your written request to do so at your authorized Mercedes-Benz Center at an additional cost.

Please contact your local authorized Mercedes-Benz Center or call our Customer Assistance Center at 1-800-FOR-MERCEdes (1-800-367-6372) for details.



Airbags are designed to activate only in certain frontal (front airbags) impacts, side impacts (side impact and head protection window curtain airbags) which exceed preset thresholds, and in certain rollovers (head protection window curtain airbags). Only during these events will they provide their supplemental protection.

The driver and passengers should always wear their seat belts. Otherwise it is not possible for airbags to provide their supplemental protection.

In case of other types of impacts and impacts below airbag deployment thresholds, airbags will not be activated. The driver and passengers will then be protected to the extent possible by a properly fastened seat belt. A properly fastened seat belt is also needed to provide the best possible protection in a rollover.

We caution you not to rely on the presence of the airbags in order to avoid wearing your seat belt.

Your vehicle was originally equipped with airbags that are designed to activate in certain impacts exceeding a preset threshold to reduce the potential and severity of injury. It is important for your safety and that of your passengers that you replace deployed airbags and repair any malfunctioning airbags to ensure that the vehicle will continue to provide supplemental crash protection for occupants.

## Safety and Security

### Occupant safety

#### Safety guidelines for the seat belt, emergency tensioning device and airbag

##### Warning!



- Damaged seat belts or belts that were highly stressed in an accident must be replaced and their anchoring points must also be checked. Use only belts installed or supplied by an authorized Mercedes-Benz Center.
- Airbags and pyrotechnic emergency tensioning devices (ETDs) are designed to function on a one-time only basis. An airbag or ETD that was activated must be replaced. PRE-SAFE has electrically operated reversible pre-tensioners in addition to the pyrotechnic ETDs.
- No modifications of any kind may be made to any components or wiring of the SRS. This includes changing or removing any component or part of the SRS, the installation of additional trim material, badges, etc. over the steering wheel hub, passenger front airbag

cover, door trim panels, or door frame trims, and installation of additional electrical/electronic equipment on or near SRS components and wiring. Keep area between airbags and occupants free from objects (e.g. packages, purses, umbrellas, etc.).

- Do not pass belts over sharp edges. They could tear.
  - Do not make any modification that could change the effectiveness of the belts.
  - Do not bleach or dye seat belts as this may severely weaken them. In a crash they may not be able to provide adequate protection.
  - Do not hang items such as coat hangers from the coat hooks or handles over the door. These items may turn into projectiles and cause head and other injuries when curtain airbag is deployed.
  - Never place your feet on the instrument panel, dashboard, or on the seat. Always keep both feet on the floor in front of the seat.
- An airbag system component within the steering wheel gets hot after the airbag has inflated. Do not touch.
  - In addition, improper repair work on the SRS creates a risk of rendering the SRS inoperative or causing unintended airbag deployment. Work on the SRS must therefore only be performed by qualified technicians. Contact an authorized Mercedes-Benz Center.
  - For your protection and the protection of others, when scrapping the airbag unit or emergency tensioning device, our safety instructions must be followed. These instructions are available from your authorized Mercedes-Benz Center.
  - Given the considerable deployment speed and the textile structure of the airbags, there is the possibility of abrasions or other injuries resulting from airbag deployment.

## Safety and Security

### Occupant safety

When you sell your vehicle we strongly urge you to give notice to the subsequent owner that it is equipped with an SRS by alerting them to the applicable section in the Operator's Manual.

#### Front airbags



- ① Driver airbag
- ② Passenger front airbag

Driver and passenger front airbags are deployed:

- in the event of a frontal impact
- if impact exceeds a preset deployment threshold
- independently of the side impact airbags

The airbags will not deploy in impacts which do not exceed the system's deployment thresholds. You will then be protected by the fastened seat belts.

The passenger front airbag will only be deployed if:

- the front passenger seat is occupied
- the PASSENGER AIRBAG OFF indicator lamp in the center console is not lit (▷ page 71)
- the impact exceeds a preset deployment threshold



Do not place objects heavier than 20 lbs (9 kg) on the front passenger seat. This could cause the front or side impact airbag on the front passenger side to deploy in a crash which exceeds the system's deployment threshold.

#### Side impact airbags, window curtain airbags

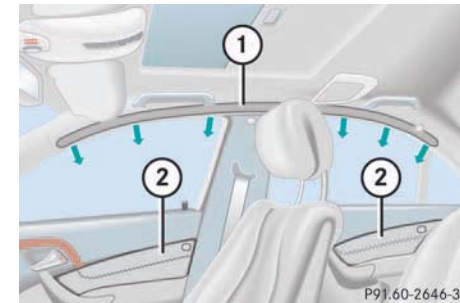

- ① Window curtain airbag
- ② Side impact airbags



## Safety and Security

### Occupant safety

The side impact airbags and window curtain airbags are deployed:

- on the impacted side of the vehicle
- in impacts exceeding a preset deployment threshold
- independently of the front airbags



In addition, the window curtain airbags are deployed:

- in certain vehicle rollovers

The side impact airbags and window curtain airbags are not deployed in impacts which do not exceed the system's deployment threshold.

The front passenger side impact airbag will only deploy if the system senses that the front passenger seat is occupied.

### Seat belts

When the engine is started, the seat belt telltale  illuminates to remind you and your passengers to fasten your seat belts. If the driver's seat belt is not fastened before the engine is started, the seat belt telltale  illuminates and a warning chime sounds for approximately six seconds when the engine is started.

The use of seat belts and infant and child restraint systems is required by law in all 50 states, the District of Columbia, the U.S. territories and all Canadian provinces. Even where this is not the case, all vehicle occupants should have their seat belts fastened whenever the vehicle is in motion.

For more information, see "Fastening the seat belts" (▷ page 40).



For information on infants and children traveling with you in the vehicle and restraint systems for infants and children, see "Children in the vehicle" (▷ page 69).

### Warning!



Always fasten your seat belt before driving off. Always make sure your passengers are properly restrained, even those sitting in the rear and pregnant women.

Failure to wear and properly fasten and position your seat belt greatly increases your risk of injuries and their likely severity in an accident. You and your passengers should always wear seat belts.

## Safety and Security

### Occupant safety

If you are ever in an accident, your injuries can be considerably more severe without your seat belt properly buckled. Without your seat belt buckled, you are much more likely to hit the interior of the vehicle or be ejected from it. You can be seriously injured or killed.

In the same crash, the possibility of injury or death is lessened if you are properly wearing your seat belt. Airbags can only protect as they are designed if the occupants are properly wearing their seat belts.

#### Warning!



Never ride in a moving vehicle with the seat backrest in an excessively reclined position as this can be dangerous. You could slide under the seat belt in a collision. If you slide under it, the belt would apply force at the abdomen or neck. That could cause serious or even fatal injuries. The seat backrest and seat belt provide the best restraint when the wearer is in a nearly upright position and the belt is properly positioned on the body.

#### Warning!



Never let more people ride in the vehicle than there are seat belts available. Be sure everyone riding in the vehicle is correctly restrained with a separate seat belt. Never use a seat belt for more than one person at a time.

#### Warning!



Damaged seat belts or belts that were highly stressed in an accident must be replaced and their anchoring points must also be checked.

Only use seat belts which have been approved by Mercedes-Benz.

Do not make any modifications to the seat belts. This can lead to unintended activation or to failure.

Do not bleach or dye seat belts as this may severely weaken them. In a crash, they may not be able to provide adequate protection.

Have all work carried out only by qualified technicians. Contact an authorized Mercedes-Benz Center.

## Safety and Security

### Occupant safety

#### Warning!



#### USE SEAT BELTS PROPERLY

- Seat belts can only work when used properly. Never wear seat belts in any other way than as described in this section, as that could result in serious injuries in case of an accident.
- Each occupant should wear their seat belt at all times, because seat belts help reduce the likelihood of and potential severity of injuries in accidents, including rollovers. The integrated restraint system includes SRS (driver airbag, passenger front airbag, side impact airbags, head protection window curtain airbags for side windows), ETD (seat belt emergency tensioning device), and front seat knee bolsters. The system is designed to enhance the protection offered to properly belted occupants in certain frontal (front airbags and ETD) and side (side impact, window curtain airbags and ETD) impacts which exceed preset deployment thresholds and in certain

rollovers (window curtain airbags and ETD).

- Never wear the shoulder belt under your arm, against your neck or off your shoulder. In a crash, your body would move too far forward. That would increase the chance of head and neck injuries. The belt would also apply too much force to the ribs or abdomen, which could severely injure internal organs such as your liver or spleen.
  - Never wear belts over rigid or breakable objects in or on your clothing, such as eyeglasses, pens, keys, etc., as these might cause injuries.
  - Position the lap belt as low as possible on your hips and not across the abdomen. If the belt is positioned across your abdomen, it could cause serious injuries in a crash.
  - Never use a seat belt for more than one person at a time. Do not fasten a seat belt around a person and another person or other objects.
- Belts should not be worn twisted. In a crash, you wouldn't have the full width of the belt to manage impact forces. The twisted belt against your body could cause injuries.
  - Pregnant women should also use a lap-shoulder belt. The lap belt portion should be positioned as low as possible on the hips to avoid any possible pressure on the abdomen.
  - Never place your feet on the instrument panel, dashboard or on the seat. Always keep both feet on the floor in front of the seat.

## Safety and Security

### Occupant safety

#### Emergency tensioning device (ETD), seat belt force limiter

The seat belts for the front and rear outer seats are equipped with emergency tensioning devices and belt force limiters.

The ETD is designed to activate in the following cases:

- in frontal or rear-end impact exceeding a preset severity level
- in certain vehicle rollovers
- if the restraint systems are operational and functioning correctly, see **SRS** indicator lamp (▷ page 58)



The ETDs for the front seats will only activate if the respective front seat belt is fastened (latch plate properly inserted into buckle).

The ETDs for the rear outer seats will activate with or without the respective seat belt fastened.

In an impact, emergency tensioning devices remove slack from the belts in such a way that the seat belts fit more snugly against the body. Belt force limiters reduce the force exerted by the seat belts on occupants during a crash.

#### Warning!



A pyrotechnic emergency tensioning device (ETD) that was activated must be replaced.

When disposing of the pyrotechnic emergency tensioning device, our safety instructions must be followed. These are available at your authorized Mercedes-Benz Center.

PRE-SAFE has electrically operated reversible pre-tensioners that do not require replacement after activation.



Do not place objects heavier than 20 lbs (9 kg) on the front passenger seat. This could cause the front or side impact airbag on the front passenger side to deploy in a crash which exceeds the system's deployment threshold.

#### Automatic comfort-fit feature seat belt

An automatic comfort-fit feature for front seats and for the rear outer seats (only for vehicles with electrically adjustable rear bench seat\* or with individual seats\* in the rear) reduces the retracting force of the seat belts when they are in normal use.

## Safety and Security

### Occupant safety

#### Preventive occupant safety (PRE-SAFE)

##### Warning



The PRE-SAFE system is intended to reduce the effects of an accident on properly seat belted vehicle occupants. Despite having the PRE-SAFE systems in your car, the possibility of injuries occurring as a result of an accident cannot be totally eliminated. Therefore you should always drive carefully and adjust your driving to the prevailing road, weather, and traffic conditions.

Your vehicle automatically takes preventive measures to better protect the occupants in the following hazardous situations:

- You execute an emergency braking maneuver and the Brake Assist System (▷ page 78) is activated.
- The PRE-SAFE system detects a critical driving dynamics situation.

In such cases, the following systems are automatically activated:

- A front seat belt with the seat belt buckled is pre-tensioned electrically.
- If the occupied front passenger seat or rear seats are in an unfavorable position, they are adjusted to a better position. Rear seat adjustment occurs only in vehicles with individual seats\* in the rear.
- The sliding/pop-up roof closes if the vehicle is in a severe skid or is spinning.



The PRE-SAFE systems are activated in the previously described circumstances only at speeds exceeding 22 mph (35 km/h).

When the driving dynamic situation has passed without an accident occurring, the pre-tensioning on the seat belts is deactivated.

You can then adjust the seats and the sliding sunroof to their previous position.

If the seat belts do not release:

- ▶ Adjust the backrest or seat slightly to the rear until the seat belt tension is diminished.

The locking mechanism releases.

#### Children in the vehicle

If an infant or child is traveling with you in the vehicle:

- Secure the child using an infant or child restraint appropriate for the age and size of the child.
- Make sure the infant or child is properly secured by a belt at all times while the vehicle is in motion.

Infant and child restraint seats and information on choosing an appropriate restraint system can be obtained from any authorized Mercedes-Benz Center.

#### Infant and child restraint systems

Use only a BabySmart<sup>TM1</sup> compatible child restraint for the front passenger seat in this vehicle.

We recommend all infants and children be properly restrained at all times while the vehicle is in motion.

<sup>1</sup> BabySmart<sup>TM</sup> is a trademark of Siemens Automotive Corp.

All lap-shoulder belts except the driver's seat belt have special seat belt retractors for secure fastening of child restraints.

To fasten a child restraint, follow child restraint instructions for mounting. Then pull the shoulder belt out completely and let it retract. During seat belt retraction, a ratcheting sound can be heard to indicate that the special seat belt retractor is activated. The belt is now locked. Push down on child restraint to take up any slack.

To deactivate, release seat belt buckle and let seat belt retract completely. The seat belt can again be used in the usual manner.



For more information on child seats with mounting fittings for tether anchorages, see "Installation of infant and child restraint systems" (▷ page 72).

For information on LATCH-type child seat mounts (▷ page 73).

#### Warning!



Never release the seat belt buckle while the vehicle is in motion, since the special seat belt retractor will be deactivated.



The use of infant or child restraints is required by law in all 50 states, the District of Columbia, the U.S. territories, and all Canadian provinces.

Infants and small children should be seated in an appropriate infant or child restraint system properly secured by a lap-shoulder belt or, if so equipped, a child restraint lower anchorage system that complies with U.S. Federal Motor Vehicle Safety Standards 213 and 225 and Canadian Motor Vehicle Safety Standards 213 and 210.2.

## Safety and Security

### Occupant safety

A statement by the child restraint manufacturer of compliance with this standard can be found on the instruction label on the restraint and in the instruction manual provided with the restraint.

When using any infant or child restraint system, be sure to carefully read and follow all manufacturer's instructions for installation and use.

Please read and observe warning labels affixed to inside of vehicle and to infant or child restraints.

#### Warning!



Children 12 years old and under must never ride in the front seat, except in a Mercedes-Benz authorized BabySmart™ compatible child seat, which operates with the BabySmart™ system installed in the vehicle to deactivate the passenger front airbag when it is properly installed. Otherwise they will be struck by the airbag when it inflates in a crash. If this happens, serious or

fatal injury will result.

According to accident statistics, children are safer when properly restrained in the rear seating positions than in the front seating positions. Infants and small children must ride in back seats and be seated in an appropriate infant or child restraint system, which is properly secured with the vehicle's seat belt and top tether strap, or secured via lower anchors and top tether strap, fully in accordance with the child seat manufacturer's instructions.

Infants and small children should never share a seat belt with another occupant. During an accident, they could be crushed between the occupant and seat belt.

Children too big for child restraint systems must ride in back seats using regular seat belts. Position shoulder belt across chest and shoulder, not face or neck. A booster seat may be necessary to achieve proper belt positioning for children from 41 lbs until they reach a height where a lap/shoulder belt fits properly without a booster.

A child's risk of serious or fatal injuries is significantly increased if the child restraints are not properly secured in the vehicle and the child is not properly secured in the child restraint.

When the child restraint is not in use, remove it from the vehicle or secure it with the seat belt to prevent the child restraint from becoming a projectile in the event of an accident.

Do not leave children, unattended in the vehicle, even if the children are secured in a child restraint system. Unsupervised children in a child restraint system may use vehicle equipment and cause an accident and/or serious personal injury.

#### BabySmart™<sup>1</sup> airbag deactivation system



##### ① Indicator lamp

Special BabySmart™ compatible child seats, designed for use with the Mercedes-Benz system and available at any authorized Mercedes-Benz Center are required for use with the BabySmart™ airbag deactivation system. With the special child seat properly installed, the passenger front airbag will not deploy.

<sup>1</sup> BabySmart™ is a trademark of Siemens Automotive Corp.

The “PASSENGER AIRBAG OFF” indicator lamp ① located in the center console will be illuminated, except with the SmartKey removed or in starter switch position 0.



The system does not deactivate the side impact airbag or the emergency tensioning device.

#### Self-test BabySmart™ without special child seat installed

After turning the SmartKey in the starter switch to position 1 or 2 or pressing the KEYLESS-GO\* start/stop button once or twice, the PASSENGER AIRBAG OFF indicator lamp ① located in the center console comes on for approximately six seconds and then goes out.

If the indicator lamp should not come on or is continuously lit, the system is not functioning. You must see an authorized Mercedes-Benz Center before seating any child on the front passenger seat.

For more information, see “Practical hints” (▷ page 303).

#### Warning!



The BabySmart™ airbag deactivation system will ONLY work with a special child seat designed to operate with it. It will not work with child seats which are not BabySmart™ compatible.

Never place anything between seat cushion and child seat (e.g. pillow), since it reduces the effectiveness of the deactivation system. The bottom of the child seat must make full contact with the passenger seat cushion. An incorrectly mounted child seat could cause injuries to the child in case of an accident, instead of protecting the child.

Follow the manufacturer’s instructions for installation of special child seats.



## Safety and Security

### Occupant safety

#### Warning!



When using a BabySmart™ compatible child seat on the front passenger seat, the passenger front airbag will not deploy only if the PASSENGER AIRBAG OFF indicator lamp remains illuminated.

Make sure to check the indicator every time you use the special system child seat. Should the light go out while the restraint is installed, please check installation. If the light remains out, do not use the BabySmart™ restraint to transport children on the front passenger seat until the system has been repaired.

Do not place powered-on laptops, cell phones and like electronic devices on the front passenger seat. Signals from such devices may interfere with the BabySmart™ system. Such signal interference may cause the PASSENGER AIRBAG OFF indicator lamp not to come on during self-test or be continuously lit, indicating that the system is not functioning.

#### Installation of infant and child restraint systems

This vehicle is equipped with tether anchorages for a top tether strap at each of the rear seating positions.

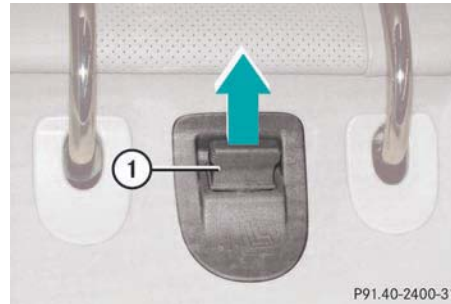

- ① Cover of top anchorage ring
- ▶ Remove cover ① from anchorage ring.
- ▶ Store cover ① in a convenient place (e.g. glove box).
- ▶ Guide tether strap between head restraint and top of seat back.

Head restraints must be positioned such that the top tether strap can pass freely between the head restraint and top of seat back.

Make sure the tether strap is not twisted.

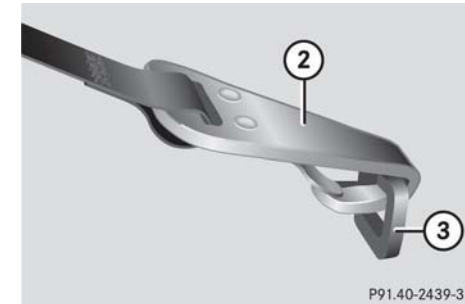

- ② Hook
- ③ Anchorage ring
- ▶ Securely fasten hook ②, which is part of the tether strap, to anchorage ring ③.

#### 1

For safety reasons, make sure the hook has attached to the ring beyond the safety catch, as illustrated.

Once the top tether anchorage hook is attached, the child restraint itself can be secured. Tighten the top tether strap according to the child restraint manufacturer's instructions.

- ▶ Reinstall cover after removing the tether strap.

#### Warning!



Vehicles with adjustable rear seats/bench\*: Never adjust the rear seat position after installing the child restraint. Adjusting the rear seat position after installing the child restraint could damage the child restraint and/or introduce undesirable slack into the webbing and loosen or misposition the child restraint, lessening the effectiveness of the child restraint and thus increasing the chance or severity of injury in an accident.

#### Child seat anchors – LATCH type

This vehicle is equipped with two LATCH (Lower Anchors and Tethers for Children) type anchors (at each of the rear seats) for the installation of a LATCH child seat with the matching anchor fittings.

If you have not installed a child seat, the LATCH anchor fittings are covered with an upholstery blend.

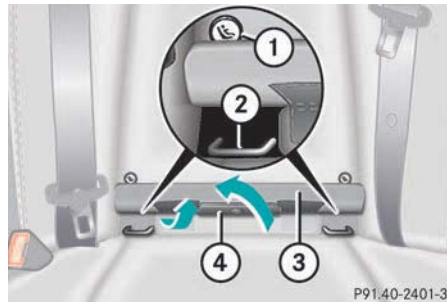

- ① Indicates the position of the anchors
- ② Anchors
- ③ Upholstery blend
- ④ Installation device

- ▶ Move rear power seats\*/bench\* to the rearmost position (▷ page 118).
- ▶ Fold upholstery blend ③ upward.
- ▶ Turn installation device ④ to a vertical position so that upholstery blend ③ does not fold down.
- ▶ Install child seat according to the manufacturer's instructions.

A solid connection is established between the child seat and the body of the vehicle.

Do not adjust rear power seat\*/bench\* position after installing child restraint.

## Safety and Security

### Occupant safety

#### Warning!



Vehicles with adjustable rear seats/bench\*: Never adjust the rear seat position after installing the child restraint. Adjusting the rear seat position after installing the child restraint could damage the child restraint and/or introduce undesirable slack into the webbing and loosen or misposition the child restraint, lessening the effectiveness of the child restraint and thus increasing the chance or severity of injury in an accident.



The child seat must be firmly attached in the right and left side anchor fittings.

Make sure the seat belt for the center seat can operate freely with a child seat installed.

Non-LATCH type child seats may also be used and can be installed using the vehicle's seat belt system. Install child seat according to the manufacturer's instructions.

#### Warning!



Children too big for child restraint systems must ride in back seats using regular seat belts. Position shoulder belt across chest and shoulder, not face or neck. A booster seat may be necessary to achieve proper belt positioning for children from 41 lbs until they reach a height where a lap/shoulder belt fits properly without a booster.

Install child seat according to manufacturer's instructions.

The child seat must be firmly attached in right and left side anchor fittings ②.

An incorrectly mounted child seat may come loose during an accident which could result in serious injury or death to your child.

Damaged or impact damaged child seats or child seat mounting fittings must be replaced.

Do not leave children unattended in the vehicle, even if the children are secured in a child restraint system.

#### Override switch for rear passenger compartment

You can disable select functions in the rear passenger compartment for added safety (for instance when you have children riding in the rear passenger compartment).

You can disable the following functions in the rear passenger compartment:

- rear door window operation (▷ page 195)
- adjustment of front passenger seat from the rear\* (▷ page 119)
- cigarette lighter in rear (▷ page 240)

## Safety and Security

### Occupant safety

The override switch is located on the driver's door.

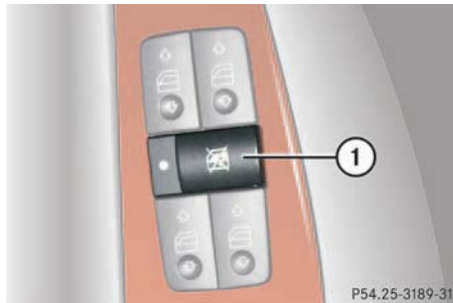

① Override switch

#### Activating override switch

- ▶ Slide override switch ① to the right.

A dot becomes visible. The functions in the rear are disabled.

#### Warning!



Activate the override switch when children are riding in the back seats of the vehicle. The children may otherwise injure themselves, e.g. by becoming trapped in the window opening.

When leaving the vehicle, always remove the SmartKey from the starter switch, take the SmartKey with KEYLESS-GO\* with you, and lock your vehicle. Do not leave children unattended in the vehicle, or with access to an unlocked vehicle. Unsupervised use of vehicle equipment may cause an accident and/or serious personal injury.

#### i

Operation of the rear door windows with the switches located in the driver's door is still possible.

#### Deactivating override switch

- ▶ Slide override switch ① to the left.

The functions in the rear are enabled again.

## Safety and Security

### Panic alarm

#### ▼ Panic alarm

An audible alarm and flashing exterior lamps will operate for approximately 2½ minutes.

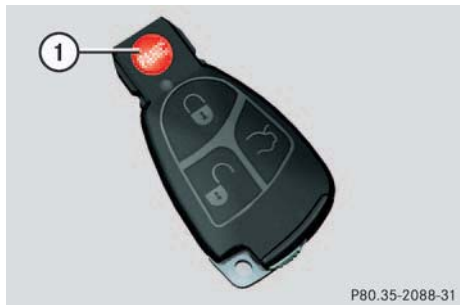

① PANIC button

#### Activating

- ▶ Press and hold button ① for at least one second.

#### Deactivating

- ▶ Press button ① again.
- or
- ▶ Insert SmartKey in starter switch.

#### i

For operation in the USA only: This device complies with Part 15 of the FCC Rules. Operation is subject to the following two conditions:

- This device may not cause harmful interference, and
- this device must accept any interference received, including interference that may cause undesired operation.

Any unauthorized modification to this device could void the user's authority to operate the equipment.

#### ▼ Driving safety systems

In this section you will find information on the following driving safety systems:

- ABS (Antilock Brake System)
- BAS (Brake Assist System)
- ESP (Electronic Stability Program)
- 4MATIC (Four Wheel Electronic Traction System)



In winter operation, the maximum effectiveness of the ABS, ESP, BAS and 4MATIC is only achieved with winter tires (M+S tires) or snow chains as required.

#### Warning!



The following factors increase the risk of accidents:

- Excessive speed, especially in turns
- Wet and slippery road surfaces
- Following another vehicle too closely

The ABS, BAS, ESP, and 4MATIC cannot reduce this risk.

Always adjust your driving style to the prevailing road and weather conditions.

#### ABS

#### Warning!



Do not pump the brake pedal. Use firm, steady brake pedal pressure instead. Pumping the brake pedal defeats the purpose of the ABS and significantly reduces braking effectiveness.

The Antilock Brake System (ABS) regulates the brake pressure so that the wheels do not lock during braking. This allows you to maintain the ability to steer your vehicle.

The ABS is functional above a speed of approximately 5 mph (8 km/h) independent of road surface conditions.

On slippery road surfaces, the ABS will respond even with light brake pressure.

## Safety and Security

### Driving safety systems

The  indicator lamp in the instrument cluster comes on when you turn the SmartKey in the starter switch to position **2** or press the KEYLESS-GO\* start/stop button twice. It goes out when the engine is running.

#### Braking

At the instant one of the wheels is about to lock up, a slight pulsation can be felt in the brake pedal, indicating that the ABS is in the regulating mode.

- ▶ Keep firm and steady pressure on the brake pedal while experiencing the pulsation.

Continuous, steady brake pedal pressure yields the advantages provided by the ABS, namely braking power and the ability to steer the vehicle.

The pulsating brake pedal can be an indication of hazardous road conditions and functions as a reminder to take extra care while driving.

#### Emergency brake maneuver

- ▶ Keep continuous full pressure on the brake pedal.

#### Warning!



The ABS cannot prevent the natural laws of physics from acting on the vehicle, nor can it increase braking or steering efficiency beyond that afforded by the condition of the vehicle brakes and tires or the traction afforded. The ABS cannot prevent accidents, including those resulting from excessive speed in turns, following another vehicle too closely, or hydroplaning. Only a safe, attentive, and skillful driver can prevent accidents. The capabilities of an ABS equipped vehicle must never be exploited in a reckless or dangerous manner which could jeopardize the user's safety or the safety of others.

For more information, see "Practical hints" (▷ page 303).

#### BAS

The Brake Assist System (BAS) operates in emergency situations. If you apply the brakes very quickly, the BAS automatically provides full brake boost, thereby potentially reducing the braking distance. Apply continuous full braking pressure until the emergency braking situation is over. The ABS will prevent the wheels from locking.

When you release the brake pedal, the brakes function again as normal. The BAS is then deactivated.

## Safety and Security

### Driving safety systems

#### Warning!



The BAS cannot prevent the natural laws of physics from acting on the vehicle, nor can it increase braking efficiency beyond that afforded by the condition of the vehicle brakes and tires or the traction. The BAS cannot prevent accidents, including those resulting from excessive speed in turns, following another vehicle too closely, or hydroplaning. Only a safe, attentive, and skillful driver can prevent accidents. The capabilities of a BAS equipped vehicle must never be exploited in a reckless or dangerous manner which could jeopardize the user's safety or the safety of others.

#### ESP

The Electronic Stability Program (ESP) monitors the vehicle's traction (force of adhesive friction between the tires and the road surface) and handling.

The ESP recognizes when a wheel is spinning or if the vehicle starts to skid. By applying brakes to the appropriate wheel and by limiting engine output, the ESP works to stabilize the vehicle. The ESP is especially useful while driving off and on wet or slippery road surfaces.

The ESP warning lamp  in the instrument cluster flashes when the ESP is engaged.

The ESP warning lamp  in the instrument cluster comes on when you turn the SmartKey in the starter switch to position **2** or press the KEYLESS-GO\* start/stop button twice. It goes out when the engine is running.

#### Warning!



Never switch off the ESP when you see the ESP warning lamp  flashing in the instrument cluster. In this case proceed as follows:

- While driving off, apply as little throttle as possible.
- While driving, ease up on the accelerator.
- Adapt your speed and driving style to the prevailing road conditions.

Failure to observe these guidelines could cause the vehicle to skid.

The ESP cannot prevent accidents resulting from excessive speed.



## Safety and Security

### Driving safety systems

#### Warning!



The ESP cannot prevent the natural laws of physics from acting on the vehicle, nor can it increase the traction afforded. The ESP cannot prevent accidents, including those resulting from excessive speed in turns, or hydroplaning. Only a safe, attentive, and skillful driver can prevent accidents. The capabilities of an ESP equipped vehicle must never be exploited in a reckless or dangerous manner which could jeopardize the user's safety or the safety of others.



The ESP will only function properly if you use wheels of the recommended tire size (▷ page 384).



Distronic\* is switched off when ESP is activated.



Vehicles without 4MATIC:  
Because of the ESP's automatic operation, the engine and ignition must be shut off (SmartKey in starter switch position **0** or **1** or KEYLESS-GO start/stop button\* in position **0** or **1**) when:

- the parking brake is being tested on a brake test dynamometer
- the vehicle is being towed with the front/rear axle raised

Active braking action through the ESP may otherwise seriously damage the brake system.

For information on vehicles with 4MATIC, see "Four wheel electronic traction system (4MATIC) with the ESP" (▷ page 82).

For more information, see "Practical hints" (▷ page 303).

### Switching off the ESP

#### Warning!



The ESP should not be switched off during normal driving other than in the circumstances described below. Disabling of the system will reduce vehicle stability in standard driving maneuvers.

To improve the vehicle's traction, turn off the ESP in driving situations where it would be advantageous to have the drive wheels spin and thus cut into surfaces for better grip such as:

- starting out on slippery surfaces and in deep snow in conjunction with snow chains
- in sand or gravel



Distronic\* cannot be activated when the ESP has been deactivated.

## Safety and Security

### Driving safety systems

The switch is located on the center console.



① ESP off / on

- ▶ Press ESP switch ① until the ESP warning lamp  in the speedometer comes on.

The ESP is deactivated.

If one or more wheels are spinning, the ESP warning lamp  in the speedometer flashes, regardless of the speed.

Traction control brakes a spinning wheel even when the ESP is deactivated.

The ESP always operates when you are braking, even when it has been deactivated.



Avoid spinning of a drive wheel for an extended period with the ESP switched off. This may cause serious damage to the drivetrain which is not covered by the Mercedes-Benz Limited Warranty.

#### Warning!



When the ESP warning lamp  is illuminated continuously, the ESP is switched off.

Adapt your speed and driving to the prevailing road conditions and to the non-operating status of the ESP.

#### Switching on the ESP

- ▶ Press the ESP switch ①.

The ESP warning lamp  in the instrument cluster goes out. You are now again in normal driving mode.

## Safety and Security

### Driving safety systems

#### Four wheel electronic traction system (4MATIC) with the ESP

Models with all-wheel drive only:

The 4MATIC improves the vehicle's ability to use available traction, e.g. during winter operation in mountains under snowy conditions, by applying power to all four wheels.

#### Warning!



If you see the ESP warning lamp  flashing in the speedometer dial, proceed as follows:

- While driving off, apply as little throttle as possible.
- While driving, ease up on the accelerator.
- Adapt your speed and driving style to the prevailing road conditions.

Failure to observe these guidelines could cause the vehicle to skid.

The ESP cannot prevent accidents resulting from excessive speed.



Do not tow with one axle raised.

Otherwise the transfer case can be damaged, which is not covered by the Mercedes-Benz Limited Warranty.



Performance testing must only be conducted on a two-axle dynamometer.

Otherwise the transfer case can be damaged, which is not covered by the Mercedes-Benz Limited Warranty.



Because of the ESP's automatic operation, the engine and ignition must be shut off (SmartKey in starter switch position **0** or **1** or KEYLESS-GO start/stop button\* in position **0** or **1**) when the parking brake is being tested on a brake test dynamometer.

Active braking action through the ESP may otherwise seriously damage the front or rear axle brake system.

Operational tests with the engine running can only be conducted on a two-axle dynamometer.

#### ▼ Anti-theft systems

##### Immobilizer

The immobilizer prevents unauthorized persons from starting your vehicle.

##### Activating

- With the SmartKey: Removing the SmartKey from the starter switch activates the immobilizer.
- With KEYLESS-GO\*: Turning off the engine by means of the start/stop button on the gear selector lever activates the immobilizer.

##### Deactivating

- With the SmartKey: Inserting the SmartKey in the starter switch deactivates the immobilizer.
- With KEYLESS-GO\*: Starting the engine by means of the start/stop button on the gear selector lever deactivates the immobilizer.



In case the engine cannot be started (yet the vehicle's battery is charged), the system is not operational. Contact an authorized Mercedes-Benz Center or call 1-800-FOR-MERCEdes (in the USA), or 1-800-387-0100 (in Canada).

##### Anti-theft alarm system

Once the alarm system has been armed, a visual and audible alarm is triggered when someone:

- opens a door
- opens the trunk
- opens the hood

The alarm will stay on even if the activating element (a door, for example) is immediately closed.

The alarm system will also be triggered when

- someone attempts to raise the vehicle
- the vehicle is opened with the mechanical key

## Safety and Security

### Anti-theft systems



If the alarm stays on for more than 20 seconds, an emergency call is initiated automatically by the Tele Aid system (▷ page 242) provided Tele Aid service was subscribed to and properly activated, and that necessary cellular service and GPS coverage are available.

#### Arming the alarm system

The alarm system is armed after locking the vehicle with the SmartKey or KEYLESS-GO\*. The turn signal lamps flash three times to indicate that the alarm system is activated. The indicator lamp in the central locking switch (▷ page 107) will flash after approximately ten seconds when the alarm system is completely armed.



If the turn signal lamps does not flash three times one of the following elements may not be properly closed:

- a door
- the trunk lid
- the hood

Close the respective element and lock the vehicle again.

#### Disarming the alarm system

The alarm system is disarmed when you unlock your vehicle with the SmartKey or KEYLESS-GO\*. The turn signal lamps flash once to indicate that the alarm system is deactivated



#### Canceling the alarm

To cancel the alarm:

##### *With the SmartKey*

- ▶ Insert the SmartKey in the starter switch.

or

- ▶ Press the  or  button on the SmartKey.

##### *With KEYLESS-GO\**

- ▶ Grasp the outside door handle.

or

- ▶ Press the KEYLESS-GO\* start/stop button.

## Safety and Security

### Anti-theft systems

#### Tow-away alarm

Once the tow-away alarm is armed, a visual and audible alarm will be triggered when someone attempts to raise the vehicle.



The tow-away protection alarm is triggered, for example, if the vehicle is lifted on one side.

If the alarm stays on for more than 20 seconds, an emergency call is initiated automatically by the Tele Aid system (▷ page 242) provided Tele Aid service was subscribed to and properly activated and that necessary cellular service and GPS coverage are available.

#### Arming tow-away alarm

When you lock your vehicle, the tow-away alarm is automatically armed after about 30 seconds.

When you unlock your vehicle, the tow-away protection disarms automatically.

#### Disarming tow-away alarm

To prevent triggering the tow-away alarm, switch off the tow-away alarm feature before towing the vehicle, or when parking on a surface subject to movement, such as a ferry or auto train.

The switch is located on the center console.



① Indicator lamp

② Tow-away alarm off switch

- ▶ Switch off the ignition and remove the SmartKey.



You cannot disarm the tow-away alarm if the ignition is switched on. ▷▷

## Safety and Security

### Anti-theft systems

- ▷▷▶ Press switch ②.

The indicator lamp ① in the button comes on briefly.

- ▶ Exit vehicle and lock your vehicle with the SmartKey or (vehicles with KEYLESS-GO\*) the lock button at each door handle.

The tow-away alarm remains disarmed until you lock your vehicle again.



#### Canceling tow-away alarm

To cancel the alarm:

##### *With the SmartKey*

- ▶ Insert the SmartKey in the starter switch.

or

- ▶ Press the  or  button on the SmartKey.

##### *With KEYLESS-GO\**

- ▶ Grasp the outside door handle.
- or
- ▶ Press the KEYLESS-GO\* start/stop button.



## **Controls in detail**

**Locking and unlocking**

**Seats**

**Memory function**

**Lighting**

**Instrument cluster**

**Control system**

**Automatic transmission**

**Good visibility**

**Automatic climate control**

**Power windows**

**Sliding/pop-up roof**

**Driving systems**

**Loading**

**Useful features**



## Controls in detail

### Locking and unlocking

In the “Controls in detail” section you will find detailed information on how to operate the equipment installed in your vehicle. If you are already familiar with the basic functions of your vehicle, this section will be of particular interest to you.

To quickly familiarize yourself with the basic functions of the vehicle, refer to the “Getting started” section of this manual. The corresponding page numbers are given at the beginning of each segment.

### ▼ Locking and unlocking

#### SmartKey

Your vehicle comes supplied with two SmartKeys, each with remote control and a removable mechanical key. The locking tabs for the mechanical key portion of the two SmartKeys are a different color to help distinguish each SmartKey unit.





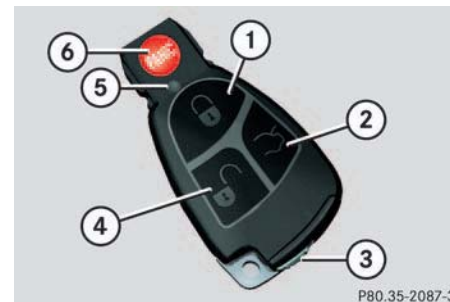

The SmartKey provides an extended operating range. To prevent theft, however, it is advisable to only unlock the vehicle when you are in close proximity to it.

The SmartKey centrally locks and unlocks:

- the doors
- the trunk
- the fuel filler flap



#### SmartKey with remote control

- ①  Lock button
- ②  Unlock button for trunk lid
- ③  Locking tab for mechanical key
- ④  Unlock button
- ⑤  Battery check lamp
- ⑥  PANIC Panic button (▷ page 76)

### Warning!



When leaving the vehicle, always remove the SmartKey from the starter switch, take the SmartKey with KEYLESS-GO\* with you and lock your vehicle. Do not leave children unattended in the vehicle, or with access to an unlocked vehicle. It is possible for children to open a locked door from the inside, which could result in an accident and/or serious personal injury.



To prevent possible malfunction, avoid exposing the SmartKey to high levels of electromagnetic radiation.



You can also open and close the power windows (▷ page 197) and sliding/pop-up roof (▷ page 201) using the SmartKey.

### Factory setting

#### Global unlocking

- ▶ Press button .

All turn signal lamps flash once. The locking knobs in the doors move up.

The vehicle will lock again automatically within approximately 40 seconds of unlocking if:

- neither door nor trunk is opened
- the SmartKey is not inserted in the starter switch
- the central locking switch is not activated

#### Global locking

- ▶ Press button .



All turn signal lamps flash three times. The locking knobs in the doors move down.

## Controls in detail

### Locking and unlocking

#### Selective setting

If you frequently travel alone, you may wish to reprogram the SmartKey so that pressing  only unlocks the driver's door and the fuel filler flap.

- ▶ Press and hold buttons  and  simultaneously for about six seconds until battery check lamp  flashes twice.

The SmartKey will then function as follows:

Unlocking driver's door and fuel filler flap

- ▶ Press button  once.

Global unlocking

- ▶ Press button  twice.



Global locking

- ▶ Press button .

## Controls in detail

### Locking and unlocking

#### Restoring to factory setting

- ▶ Press and hold buttons  and  simultaneously for about six seconds until battery check lamp  flashes twice.



If you can no longer lock or unlock the vehicle with the SmartKey, then the batteries in the SmartKey are discharged, the SmartKey is malfunctioning or the vehicle battery is drained.

- Check the batteries in the SmartKey and replace them if necessary (▷ page 349).
- Use the mechanical key to unlock the doors (▷ page 348) and the trunk lid (▷ page 349) as required.
- Have the vehicle battery and the battery connections checked.

- Use the mechanical key to lock the doors (▷ page 348) and the trunk lid (▷ page 349) as required.

If the SmartKey is malfunctioning, contact an authorized Mercedes-Benz Center.

#### Unlocking and opening the trunk lid

You can unlock and open the trunk lid separately.

A minimum height clearance of 6 ft. (1.85 m) is required to open the trunk lid.

- ▶ Press and hold button  until trunk unlocks and begins to open.



The trunk lid swings open upwards automatically. Always make sure that there is sufficient overhead clearance.

Vehicles with trunk lid opening/closing system: To stop the opening procedure, press button . The trunk lid stops moving.



If the trunk lid does not open, it is still locked separately (if applicable) (▷ page 105).

If the vehicle was previously centrally locked, the trunk lid will lock automatically when closed. The turn signals will flash three times to confirm locking.

The trunk can also be opened from its inside in an emergency, see “Trunk lid emergency release” (▷ page 104).

## Controls in detail

### Locking and unlocking

#### Checking the batteries

- ▶ Press button  or .

Battery check lamp  comes on briefly to indicate that the SmartKey batteries are in order.





If battery check lamp  does not come on briefly during check, then the SmartKey batteries are discharged.

Replace the batteries (▷ page 349).

You can obtain the required batteries at any authorized Mercedes-Benz Center.



If the batteries are checked within signal range of the vehicle, pressing the button  or  will lock or unlock the vehicle accordingly.

#### Loss of SmartKey or mechanical key

If you lose a SmartKey or mechanical key, you should do the following:

- ▶ Have the SmartKey deactivated by an authorized Mercedes-Benz Center.
- ▶ Report the loss of the SmartKey or the mechanical key immediately to your car insurance company.
- ▶ If necessary, have the mechanical lock replaced.

Your authorized Mercedes-Benz Center will be glad to supply you with a replacement.

#### SmartKey with KEYLESS-GO\*

Vehicles equipped with KEYLESS-GO come with two SmartKeys with KEYLESS-GO, each with remote control and a removable mechanical key. The locking tabs for the mechanical key portion of the two SmartKeys are a different color to help distinguish each SmartKey unit.

The KEYLESS-GO function is integrated into the SmartKey. On these vehicles, the validity of the SmartKey with KEYLESS-GO is checked every time you grasp a door handle.

If the SmartKey with KEYLESS-GO is valid, your vehicle unlocks:

- the doors
- the trunk lid
- the fuel filler flap

## Controls in detail

### Locking and unlocking

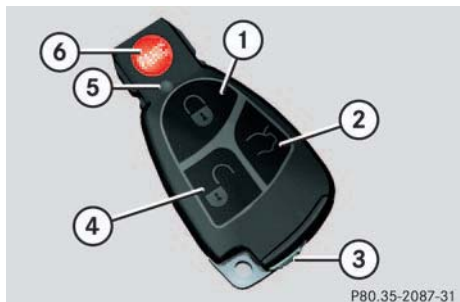

#### SmartKey with KEYLESS-GO

- ① Lock button
- ② Unlock button for trunk lid
- ③ Locking tab for mechanical key
- ④ Unlock button
- ⑤ Battery check lamp
- ⑥ PANIC button (▷ page 76)

For more information on using the SmartKey buttons, see “SmartKey” (▷ page 88).

#### Warning!



When leaving the vehicle, always remove the SmartKey from the starter switch, take the SmartKey with KEYLESS-GO\* with you and lock your vehicle. Do not leave children unattended in the vehicle, or with access to an unlocked vehicle. Unsupervised use of vehicle equipment may cause an accident and/or serious personal injury.



To prevent possible malfunction, avoid exposing the SmartKey with KEYLESS-GO to high levels of electromagnetic radiation.



If the vehicle has been parked for a longer period of time, you must pull the door handle in order to activate the KEYLESS-GO function.

You can also close the power windows (▷ page 198) and sliding/pop-up roof (▷ page 202) using the SmartKey with KEYLESS-GO.

#### Important notes on using KEYLESS-GO

- You can also use the SmartKey with KEYLESS-GO like a normal SmartKey (▷ page 88).
- You can combine KEYLESS-GO functions with normal SmartKey functions (e.g. unlocking with KEYLESS-GO and locking with the remote control).
- Always carry the SmartKey with KEYLESS-GO with you.

## Controls in detail

### Locking and unlocking

- Never store the SmartKey with KEYLESS-GO together with:
  - Electronic items such as a cellular phone or another SmartKey with KEYLESS-GO
  - Metallic objects such as coins or metal foilDoing so could impair the function of the KEYLESS-GO system.
- To lock or unlock the vehicle, the SmartKey with KEYLESS-GO must be located outside the vehicle within approximately 3 ft. (1 m) of a door or the trunk.
- In order to start the engine with the SmartKey with KEYLESS-GO:
  - The SmartKey with KEYLESS-GO must be located in the vehicle.
  - All doors must be closed.
  - The brake pedal must be firmly depressed. Do not depress the accelerator.
- If you have started the engine with the KEYLESS-GO start/stop button, you can only turn it off again with this button, even if you have put the SmartKey in the starter switch in the meantime.
- This does not apply if, after starting, the gear selector lever is still in position **P** and the SmartKey is then inserted in the starter switch. The SmartKey will then have priority over the SmartKey with KEYLESS-GO and the vehicle's electrical system will operate according to the position of the SmartKey in the starter switch, even stopping the engine.
- If the SmartKey with KEYLESS-GO is positioned farther away from the vehicle, the system may no longer recognize the SmartKey with KEYLESS-GO. The vehicle then cannot be locked or the engine started via the KEYLESS-GO system.
- If the SmartKey with KEYLESS-GO is removed from the vehicle while the engine is switched on (e.g. if passenger exits the vehicle with the SmartKey with KEYLESS-GO), the message **KEY NOT RECOGNIZED!** will appear in the multifunction display.

Find the SmartKey or change its present location immediately (e.g. place it on the front passenger seat or insert it in shirt pocket).
- Remember that the engine can be started by anyone with a SmartKey with KEYLESS-GO that is left inside the vehicle. If you leave the SmartKey with KEYLESS-GO behind when exiting and locking the vehicle, the message **KEY DETECTED IN VEHICLE!** will appear in the multifunction display.

## Controls in detail

### Locking and unlocking

#### Factory setting

##### *Global unlocking*

- ▶ Grasp the door handle.

The vehicle will lock again automatically within approximately 40 seconds of unlocking if neither door nor trunk is opened.



The vehicle could inadvertently be unlocked if the SmartKey with KEYLESS-GO is within 3 ft. (1 m) of the vehicle and:

- the door handle is splashed with water, or
- you attempt to clean the door handle

##### *Global locking*

- ▶ Press lock button at door handle (▷ page 55) or trunk (▷ page 95).

#### Selective setting

If you frequently travel alone, you may wish to reprogram the SmartKey with KEYLESS-GO so when you, grasp the driver's door handle only the driver's door and the fuel filler flap unlocks.

- ▶ Press and hold buttons and simultaneously for about six seconds until battery check lamp flashes twice.

The SmartKey with KEYLESS-GO will then function as follows:

Unlocking the driver's door

- ▶ Grasp the driver's door handle.

Global unlocking

- ▶ Grasp the door handle on the passenger side.

Global locking

- ▶ Press lock button at door handle or trunk lid.

#### Restoring to factory setting

- ▶ Press and hold buttons and simultaneously for about six seconds until battery check lamp flashes twice.



If you can not lock or unlock the vehicle with the SmartKey with KEYLESS-GO, then the battery in the SmartKey is discharged, the SmartKey with KEYLESS-GO is malfunctioning or the vehicle battery is drained.

- Check the battery in the SmartKey with KEYLESS-GO and replace them if necessary (▷ page 349).
- Use the mechanical key to unlock the doors (▷ page 348) and the trunk lid (if applicable) (▷ page 349) as required.
- Have the vehicle battery and the battery connections checked.

- Use the mechanical key to lock the doors (▷ page 348) and the trunk lid (▷ page 349) as required.

If the SmartKey with KEYLESS-GO is malfunctioning, contact an authorized Mercedes-Benz Center.

### Locking the vehicle

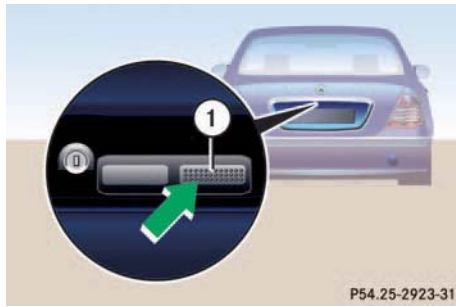

① Vehicle lock button

- ▶ Press vehicle lock button ①.
- or
- ▶ Press the lock button at the outside door handle (▷ page 55).
- or
- ▶ Vehicles with trunk lid opening/closing system\*, press the KEYLESS-GO locking/closing switch at the trunk (▷ page 103).

The vehicle locks. The turn signals flashes three times to confirm locking.

## Controls in detail

### Locking and unlocking

#### Checking the battery

- ▶ Press button or .

Battery check lamp ⑤ comes on briefly to indicate that the SmartKey battery is in order.



If battery check lamp ⑤ does not come on briefly during check, the SmartKey battery is discharged.

Replace the battery (▷ page 349).

You can obtain the required battery at any authorized Mercedes-Benz Center.



If the battery is checked within signal range of the vehicle, pressing the button or will lock or unlock the vehicle accordingly.



## Controls in detail

### Locking and unlocking

#### Loss of the SmartKey with KEYLESS-GO

If you lose your SmartKey with KEYLESS-GO or mechanical key, you should do the following:

- ▶ Have the SmartKey with KEYLESS-GO deactivated by an authorized Mercedes-Benz Center.
- ▶ Report the loss of the SmartKey with KEYLESS-GO or the mechanical key immediately to your car insurance company.
- ▶ Have the mechanical lock replaced if necessary.

Your authorized Mercedes-Benz Center will be glad to supply you with a replacement.

#### Opening the doors from the inside

You can open a locked door from the inside. Open door only when conditions are safe to do so.

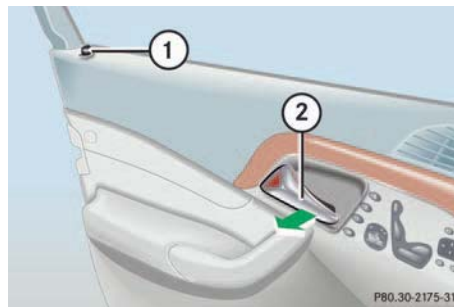

- ① Locking knob
- ② Inside door handle

- ▶ Pull on door handle ②.



If door was locked, locking knob ① will move up.

#### i

If the vehicle has previously been locked from the outside with the SmartKey, opening a door from the inside will trigger the anti-theft alarm system.

To cancel the alarm, do one of the following:

With the SmartKey

- Insert the SmartKey in the starter switch.
- Press button  or  on the SmartKey.

With KEYLESS-GO\*

- Grasp the outside door handle.
- Press the KEYLESS-GO\* start/stop button.

## Controls in detail

### Locking and unlocking

#### Opening the trunk lid from the outside

A minimum height clearance of 6 ft. (1.85 m) is required to open the trunk lid.

The trunk lid lock button is located in the rear license plate recess.

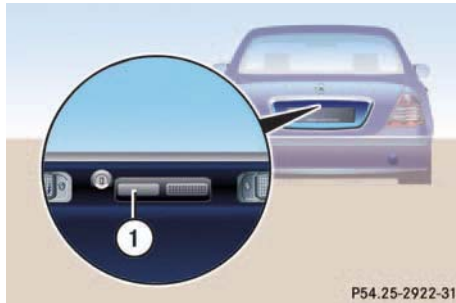

① Trunk lid lock button

- ▶ Press the outer left-hand side of trunk lid button ①.

The trunk lid opens.



The trunk lid swings open upwards automatically. Always make sure that there is sufficient overhead clearance.

Vehicles with trunk lid opening/closing system\*: To stop the opening procedure, press button . The trunk lid stops moving.



If the trunk lid does not open, it is still locked separately (if applicable) (▷ page 349).

Vehicles without KEYLESS-GO\*: The vehicle must be unlocked (▷ page 88).

Vehicles with KEYLESS-GO\*: If the vehicle was previously centrally locked, the trunk lid will lock automatically after closing it (▷ page 98). The turn signals will flash three times to confirm locking.

The trunk can also be opened using the SmartKey (▷ page 90) or from its inside in an emergency, see “Trunk lid emergency release” (▷ page 104).

#### Opening the trunk lid from the inside

You can open the trunk from the inside if the vehicle is stationary.

A minimum height clearance of 6 ft. (1.85 m) is required to open the trunk lid.

The switch is located on the driver's door.



① Indicator lamp

② Remote trunk lid release switch

- ▶ Pull remote trunk lid switch ② until trunk begins to open.

The trunk lid opens. The indicator lamp ① comes on and remains lit until the trunk is closed.

## Controls in detail

### Locking and unlocking



The trunk lid swings open upwards automatically. Always make sure that there is sufficient overhead clearance.



If the trunk lid does not open, it is still locked separately (if applicable) (▷ page 349).

If the vehicle was previously centrally locked, the trunk lid will lock automatically when closed (▷ page 98). The turn signals will flash three times to confirm locking.

The trunk can also be opened using the SmartKey (▷ page 90) or from its inside in an emergency, see “Trunk lid emergency release” (▷ page 104).

#### Closing the trunk lid



P88.50-2423-31

① Handle

- ▶ Lower trunk lid by pulling firmly on handle ①.

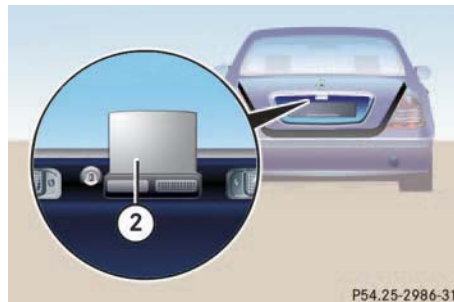

P54.25-2986-31

② Extending handle

- ▶ Push the trunk lid down gently at the extending handle ② until it engages into the lock.

The extending handle ② is retracted after a few seconds.

The power closing assist automatically ensures that the lid is pulled closed completely (▷ page 106).

#### Warning!



To prevent possible personal injury, always keep hands and fingers away from the trunk lid opening when closing the trunk. Be especially careful when small children are around.

### Warning!



Only drive with the trunk closed as, among other dangers such as visibility blockage, exhaust fumes may enter the vehicle interior.



Do not place the SmartKey in the open trunk. You may lock yourself out.

Vehicles with KEYLESS-GO\*: To prevent a possible inadvertent lockout, the trunk lid will open automatically if a SmartKey with KEYLESS-GO is recognized inside the vehicle or in the trunk.

### Trunk lid opening/closing system\*

You can open or close the trunk lid from the inside if the vehicle is stationary.

#### Opening from the inside

A minimum height clearance of 6 ft. (1.85 m) is required to open the trunk lid.

The switch for opening and closing the trunk is located on the driver's door.

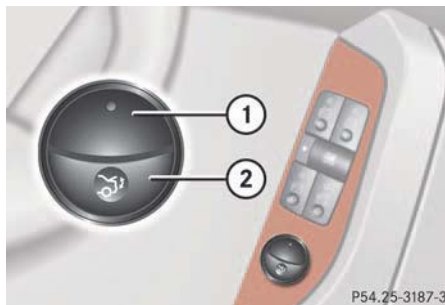

- ① Indicator lamp
- ② Remote trunk lid switch

## Controls in detail

### Locking and unlocking

- ▶ Pull remote trunk lid switch ② until trunk begins to open.

The trunk lid opens. The indicator lamp ① comes and remains lit until the trunk is closed.



The trunk lid swings open upwards automatically. Always make sure that there is sufficient overhead clearance. To stop the opening procedure, press or pull the remote trunk lid switch.



If the trunk lid does not open, it is still locked separately (if applicable) (▷ page 349).

If the vehicle was previously centrally locked, the trunk lid will lock automatically when closed (▷ page 98). The turn signals will flash three times to confirm locking.

## Controls in detail

### Locking and unlocking

The trunk can also be opened using the SmartKey (▷ page 90) or from its inside in an emergency, see “Trunk lid emergency release” (▷ page 104).

#### *Limiting opening height of trunk lid*

The trunk lid opening height can be limited when transporting goods on a roof rack (e.g. presence of an MB sport luggage container\*). When activated, the trunk lid opens to approximately the height of the roof edge.

You can activate the limiting opening height of trunk lid using the control system (▷ page 159).

#### Closing from the inside

- ▶ Press remote trunk lid switch ② (▷ page 99) until the indicator lamp ① goes out and trunk lid is closed.

To interrupt the closing procedure:

- ▶ Release remote trunk lid switch ②.

#### Warning!



Maintain sight of trunk area while operating door mounted switch. Monitor the closing procedure carefully to ensure that no one is in danger of being injured.

To interrupt the closing procedure, release the door mounted remote trunk lid switch.

Even with the SmartKey removed from the starter switch or the SmartKey with KEYLESS-GO\* removed from the vehicle, the remote trunk lid switch can be operated. Therefore, do not leave children unattended in the vehicle, or with access to an unlocked vehicle. Unsupervised use of vehicle equipment may cause an accident and/or serious personal injury.

If the trunk lid comes into contact with an object while closing (e.g. luggage that has been piled too high) in the upper motion sequence, the closing procedure is stopped and the trunk reopens slightly.

### Closing the trunk lid from the outside (vehicles without KEYLESS-GO\*)

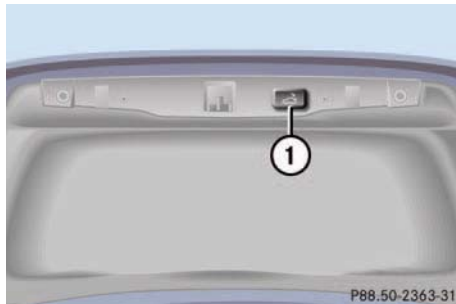

① Trunk lid closing switch

- ▶ Press trunk lid closing switch ① briefly.

The trunk lid closes.

If the trunk lid comes into contact with an object while closing (e.g. luggage that has been piled too high), the closing procedure is stopped and the trunk reopens slightly.

#### Warning!



Monitor the closing procedure carefully to ensure that no one is in danger of being injured. To prevent possible personal injury, always keep hands and fingers away from the trunk opening when closing the trunk. Be especially careful when small children are around. To stop the closing procedure, press the remote trunk lid switch (on the driver's door), the trunk lid closing switch ①, or the  button on the SmartKey.

When leaving the vehicle, always remove the SmartKey from the starter switch, take the SmartKey with you and lock your vehicle. Do not leave children unattended in the vehicle, or with access to an unlocked vehicle. Unsupervised use of vehicle equipment may cause an accident and/or serious personal injury.

## Controls in detail

### Locking and unlocking

#### Warning!



Only drive with the trunk closed as, among other dangers such as visibility blockage, exhaust fumes may enter the vehicle interior.



Do not place the SmartKey in the open trunk. You may lock yourself out.

## Controls in detail

### Locking and unlocking

#### Closing the trunk lid from the outside (vehicles with KEYLESS-GO\*)

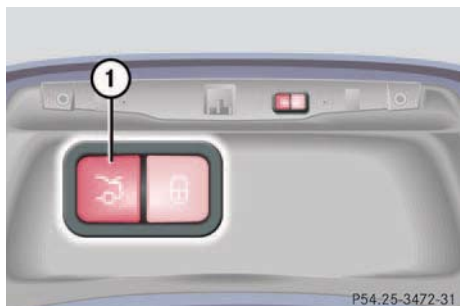

#### ① Trunk lid closing switch

- ▶ Make sure you have the SmartKey with KEYLESS-GO with you.
- ▶ Press trunk lid closing switch ① briefly.

The trunk lid closes.

If the trunk lid comes into contact with an object while closing (e.g. luggage that has been piled too high), the closing procedure is stopped and the trunk reopens slightly.

#### Warning!



Monitor the closing procedure carefully to ensure that no one is in danger of being injured. To prevent possible personal injury, always keep hands and fingers away from the trunk opening when closing the trunk. Be especially careful when small children are around. To stop the closing procedure, press the trunk lid closing switch (on the driver's door), the trunk lid closing switch ① or the  button on the SmartKey.

When leaving the vehicle, always remove the SmartKey from the starter switch, take the SmartKey with KEYLESS-GO\* with you, and lock your vehicle. Do not leave children unattended in the vehicle, or with access to an unlocked vehicle. Unsupervised use of vehicle equipment may cause an accident and/or serious personal injury.

#### Warning!



Only drive with the trunk closed as, among other dangers such as visibility blockage, exhaust fumes may enter the vehicle interior.

#### ①

To prevent a possible inadvertent lock-out, the trunk lid will open automatically if a SmartKey with KEYLESS-GO is recognized inside the vehicle or in the trunk.

### Closing the trunk lid and locking the vehicle from the outside (vehicles with KEYLESS-GO\*)

On vehicles with trunk lid opening/closing system and KEYLESS-GO, you can close the trunk lid and lock the vehicle simultaneously.

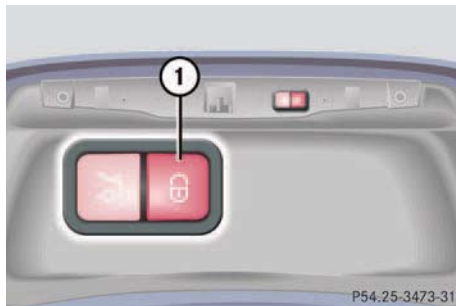

① KEYLESS-GO locking/closing switch

- ▶ Make sure you have the SmartKey with KEYLESS-GO with you.
- ▶ Press switch ① briefly.

The vehicle is locked and the trunk lid closes automatically. The turn signals flash three times to confirm locking.

#### Warning!



Monitor the closing procedure carefully to ensure that no one is in danger of being injured. To prevent possible personal injury, always keep hands and fingers away from the trunk opening when closing the trunk. Be especially careful when small children are around. To stop the closing procedure, press the remote trunk lid switch (on the driver's door), the trunk lid closing switch ②, or the  button on the SmartKey.

When leaving the vehicle, always remove the SmartKey from the starter switch, take the SmartKey with KEYLESS-GO\* with you, and lock your vehicle. Do not leave children unattended in the vehicle, or with access to an unlocked vehicle. Unsupervised use of vehicle equipment may cause an accident and/or serious personal injury.

## Controls in detail

### Locking and unlocking

#### Warning!



Only drive with the trunk closed as, among other dangers such as visibility blockage, exhaust fumes may enter the vehicle interior.



To prevent a possible inadvertent lock-out, the trunk lid will open automatically if a SmartKey with KEYLESS-GO is recognized inside the vehicle or in the trunk.



## Controls in detail

### Locking and unlocking

#### Trunk lid emergency release

The emergency release button is located on the inside of the trunk lid.



① Emergency release button

- ▶ Briefly press emergency release button ①.

The trunk unlocks and the trunk lid opens.



The emergency release button unlocks and opens the trunk while the vehicle is standing or driving.

The emergency release button does not open the trunk lid if the vehicle battery is discharged or disconnected.

Illumination of the emergency release button:



- The button will flash for 30 minutes after opening the trunk.
- The button will flash for 60 minutes after closing the trunk.



If the emergency release button is pressed and the vehicle was centrally locked, the exterior lamps will flash and the alarm will sound as the trunk lid opens:

To cancel the alarm, do one of the following:

With the SmartKey

- Insert the SmartKey in the starter switch.
- Press button  or  on the SmartKey.

With KEYLESS-GO\*

- Grasp the outside door handle.
- Press the KEYLESS-GO\* start/stop button.

### Separately locking the trunk lid



Your vehicle may be equipped with a function permitting the separate locking of the trunk using the mechanical key. If present, this feature can permit you to deny any unauthorized person access to the trunk by locking the trunk separately and leaving the SmartKey less the mechanical key with the vehicle.

To verify the presence of this feature, use the mechanical key to lock the trunk and then attempt to open the trunk by pressing the trunk lid button after the vehicle has been centrally unlocked with the SmartKey.

The lock is located next to the recessed handle.

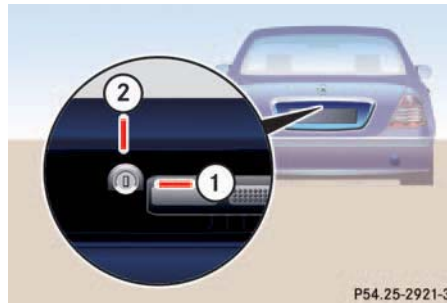

- ① Locked
- ② Neutral position
- ▶ Close the trunk lid (▷ page 98).
- ▶ Pull the mechanical key out of the SmartKey (▷ page 348).
- ▶ Insert the mechanical key into the trunk lid lock.
- ▶ Turn the mechanical key clockwise to position ①.

The trunk remains locked even when the vehicle is centrally unlocked.

## Controls in detail

### Locking and unlocking



You can only cancel the separate trunk locking mode by means of the mechanical key.

### Separately unlocking the trunk lid

- ▶ Pull the mechanical key out of the SmartKey (▷ page 348).
- ▶ Insert the mechanical key into the trunk lid lock.
- ▶ Turn the mechanical key counterclockwise to neutral position ②, see above.

You can now open the trunk (▷ page 97).

A minimum height clearance of 6 ft. (1.85 m) is required to open the trunk lid.

#### Warning!



Only drive with the trunk closed as, among other dangers such as visibility blockage, exhaust fumes may enter the vehicle interior.

## Controls in detail

### Locking and unlocking

#### Power closing assist for doors and trunk lid

##### Power closing assist for doors

- ▶ Press the doors gently past the initial engage position into the lock.  
The doors close automatically.

##### Power closing assist for trunk lid

- ▶ Press the trunk lid gently into its lock.  
The trunk closes automatically.



It is not necessary to slam the door or trunk lid closed. A pneumatic power-assisted mechanism draws doors and trunk lid closed quietly and automatically once door and trunk lid has been latched. When the pneumatic power-assisted mechanism has stopped, doors and/or trunk can be re-opened.

#### Warning!



To prevent possible personal injury, always keep hands and fingers away from the door or trunk opening when closing a door or the trunk lid. Be especially careful when small children are around.

In case of danger, pull the inside or outside door handle, or press the trunk lid lock.

To prevent personal injury, never actuate the closing assist mechanism by tampering with the door or trunk lid latch.

#### Automatic central locking

The doors and the trunk automatically lock when the ignition is switched on and the wheels are turning at vehicle speeds of approximately 9 mph (15 km/h) or more.

You can open a locked door from the inside. Open door only when conditions are safe to do so.



The doors unlock automatically after an accident if the force of the impact exceeds a preset threshold.

The vehicle locks automatically when the ignition is switched on and the wheels are turning at vehicle speeds of approximately 9 mph (15 km/h) or more. You could therefore lock yourself out when the vehicle

- is pushed or towed
- is on a test stand

For more information on towing the vehicle, see “Towing the vehicle” (▷ page 371).

You can deactivate the automatic locking using the control system (▷ page 159).

### Locking and unlocking from the inside

You can lock or unlock the doors and the trunk from inside using the central locking or unlocking switch. This can be useful, for example, if you want to lock the vehicle before starting to drive.

The fuel filler flap will not be locked or unlocked with the central locking or unlocking switch, respectively.

#### Warning!



When leaving the vehicle, always remove the SmartKey from the starter switch, take the SmartKey with KEYLESS-GO\* with you and lock your vehicle. Do not leave children unattended in the vehicle, or with access to an unlocked vehicle. Unsupervised use of vehicle equipment may cause an accident and/or serious personal injury.

The switches are located in the center console.

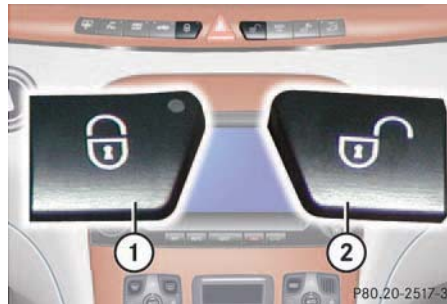

#### Central locking/unlocking switches

- ① Locking
- ② Unlocking

#### Locking

- ▶ Press central locking switch ①.

If all door's are closed, the vehicle locks.

#### Unlocking

- ▶ Press central unlocking switch ②.

The vehicle unlocks.

## Controls in detail

### Locking and unlocking



You can open a locked door from the inside. Open door only when conditions are safe to do so.

If the vehicle was previously centrally locked with the SmartKey or the SmartKey with KEYLESS-GO\* it will not unlock using the central locking switch.

If the vehicle was previously locked with the central locking switch:

- While in the global remote control mode, the vehicle is unlocked completely when a door is opened from the inside.
- While in the selective remote control mode, only the door opened from inside is unlocked.

## Controls in detail

### Seats

#### ▼ Seats

For more information on seat adjustment, see “Seat adjustment” (▷ page 35).

#### Easy-entry/exit feature

With the easy-entry/exit feature activated, the steering wheel tilts upwards and the driver’s seat moves to the rear.

This allows easier entry into and exit from the vehicle when the driver’s door is opened. However, the engine must be turned off.

When the SmartKey is inserted in the starter switch or you have pressed the KEYLESS-GO\* start/stop button once and the driver’s door is closed, the steering wheel and the driver’s seat return to their last set positions.

#### Warning!



You must ensure that no one can become trapped or injured by the moving steering wheel and driver’s seat when the easy-entry/exit feature is activated, the driver’s door is being opened, and the engine is turned off or the SmartKey is removed from the starter switch.

Do not leave children unattended in the vehicle, or with access to an unlocked vehicle. Children could open the driver’s door and unintentionally activate the easy-entry/exit feature\*, which could result in an accident and/or serious personal injury.

You can activate the following functions:

- Steering column  
Only the steering column is adjusted.
- Steering column and seat  
The steering column and the seat are adjusted.

The easy-entry/exit feature can be switched on or off in the convenience submenu of the control system (▷ page 160).

#### i

To cancel seat/steering wheel movement, do one of the following:

- Press the seat adjustment switch (▷ page 35)
- Move the steering column stalk (▷ page 37)
- Press the memory button (▷ page 121)

## Removing and installing front seat head restraints

For information on head restraint adjustment, see the “Getting started” section (> page 36)

### Warning!



For your protection, drive only with properly positioned head restraints.

Adjust head restraint so that the center of the head restraint supports the back of the head at eye level. This will reduce the potential for injury to the head and neck in the event of an accident or similar situation.

Do not drive the vehicle without the seat head restraints. Head restraints are intended to help reduce injuries during an accident.



Tilt the seat backrest to the rear for easier removal and installation of the head restraints.

### Front seat head restraints

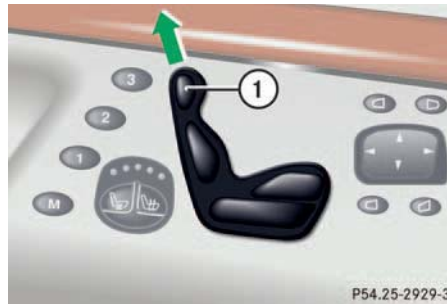

① Head restraint height switch

## Controls in detail

### Seats

#### Removing front head restraints

- ▶ Press switch ① upwards and hold until the head restraint is fully extended.
- ▶ Pull out head restraint.

#### Installing front head restraints:

- ▶ Press switch ① upwards and hold for about five seconds.
- ▶ Push the head restraint down until it engages.
- ▶ Adjust head restraint to desired position (> page 35).

## Controls in detail

### Seats

#### Rear seat head restraints



The rear head restraints cannot be removed.

#### Folding head restraints back

The rear seat head restraints and the rear seat power head restraints\* can be folded backward for increased visibility.



① Switch in the front center console

- ▶ Make sure the ignition is switched on.  
All the lamps in the instrument cluster come on.
- ▶ Press switch ① in the front center console briefly.  
The rear head restraints will fold backward.

#### Warning!



For safety reasons, always drive with the rear head restraints in the upright position when the rear seats are occupied.  
Keep the area around head restraints clear of articles (e.g. clothing) to not obstruct the folding operation of the head restraints.

#### Placing head restraints upright



P91.16-2220-31

- ▶ Pull the rear head restraint upright until it locks into position.



Make sure the head restraints engage when placing them upright manually. Otherwise their protective function cannot be ensured.

#### Placing power head restraints\* upright

- ▶ Make sure the ignition is switched on.  
All the lamps in the instrument cluster come on.
- ▶ Press switch ① in the front center console and hold.  
The rear head restraints will fold upright.

#### Folding back and placing upright power head restraints\* with the switches in the rear doors

You can fold the rear power head restraints backward or upright using the head restraint folding switches in the respective rear doors.



① Head restraint switch, rear

- ▶ Make sure the ignition is switched on.  
All the lamps in the instrument cluster come on.

- ▶ Press switch up in direction of arrow ①.  
The rear power head restraint will fold upright.
- ▶ Press switch down in direction of arrow ①.  
The rear power head restraint will fold backward.

#### Warning!



For safety reasons, always drive with the rear head restraints in the upright position when the rear seats are occupied.

Keep the area around head restraints clear of articles (e.g. clothing) to not obstruct the folding operation of the head restraints.

#### Head restraint tilt

You can adjust the angle manually by pulling or pushing the head restraints by hand.



## Controls in detail

### Seats

#### Lumbar support

You can adjust the contour of the seat's lumbar support to best support your spine. The thumbwheel for the driver's and front passenger's seat are located on the inner side of the seat.

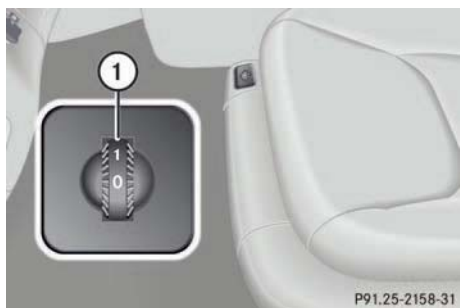

#### ① Thumbwheel

- ▶ Make sure the ignition is switched on.  
All the lamps in the instrument cluster come on.
- ▶ Set the lumbar support between 0 and 5.

#### Multicontour backrest\*

The multicontour backrest has inflatable air cushions built into the seat backrest to provide additional lumbar and side support.

The seat backrest cushion height and curvature can be continuously varied with switches on the right side of the seat after turning the SmartKey in the starter switch to position 2 or pressing the KEYLESS-GO\* start/stop button twice.

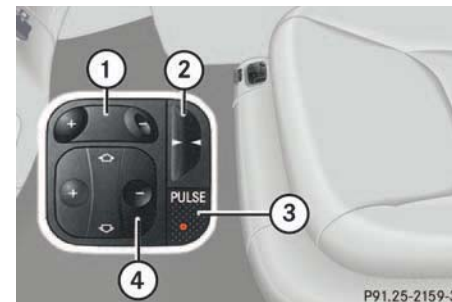





- ① Shoulder region support
- ② Side bolster adjustment
- ③ Massage function (PULSE)
- ④ Lumbar region support

- ▶ Make sure the ignition is switched on.  
All lamps in the instrument cluster come on.

#### Shoulder region support

- ▶ Press **+** or **-** on switch ①.  
The air cushion inflates or deflates.

### Lumbar region support

- ▶ Press  or  on rocker switch ④.  
This selects the air cushion you wish to adjust.
- ▶ Press  or  on rocker switch ④.  
The air cushion inflates or deflates.

### Side bolsters adjustment

- ▶ Adjust the side bolsters so that they provide good lateral support using switch ②.



When the engine is turned off, the last cushion setting is retained in memory, and the cushion is automatically adjusted to this setting when the engine is restarted.

### Massage function (PULSE)

You can reduce muscle tension during long trips by periodically using the massage function.

- ▶ Press button ③.  
The indicator lamp on button ③ comes on. The air cushions in the lumbar region inflate and deflate rhythmically.



The massage function switches off automatically after approximately eight minutes. The indicator lamp extinguishes.

## Controls in detail

### Seats

### Drive-dynamic seat\*

The drive-dynamic seat automatically adjusts the lateral support provided by the seat backrest to your driving style.



- ① Activate drive-dynamic function

The drive-dynamic seat electronically controls the air pressure in the air chambers of the seat backrest side bolsters. This function improves driving comfort and pleasure.

## Controls in detail

### Seats

#### Activating

- ▶ Press button ①.

The indicator lamp in the switch comes on and the following message appears in the multifunction display for five seconds:



You can adjust the characteristics of the drive-dynamic seat using the control system (▶ page 163).

#### Deactivating

- ▶ Press button ① again.

The indicator lamp in the button goes out.

The message:

DRIV. DYN. SEAT ADJ.

DRIVER

OFF

appears in the multifunction display.



When the engine is turned off, the last cushion setting retained in memory.

The cushion is automatically adjusted to this setting when the engine is restarted.

#### Seat heating\*

##### Vehicles without seat ventilation\*

The switch is located on the door.



① Normal heating

② Rapid heating

- ▶ Switch on ignition.

##### Switching on seat heating

- ▶ Press switch ①.

A red indicator lamp above the switch comes on.

#### Switching off seat heating

- ▶ Press switch ① again.



The seat heating will be automatically switched off after approximately 30 minutes.

#### Switching on rapid seat heating

- ▶ Press switch ②.

Both red indicator lamps above the switch come on.



The system switches over to normal heating mode after approximately five minutes. Only the right-hand indicator lamp remains lit.

#### Switching off rapid seat heating mode

- ▶ Press switch ② again.



If one or both of the lamps on the seat heating switch are flashing, there is insufficient voltage available since too many electrical consumers are turned on. The seat heating switches off automatically.

The seat heating will switch back on again automatically as soon as sufficient voltage is available.

#### Vehicles with seat ventilation\*

The switch is located on the door. The red indicator lamps on the switch show the heating level selected:

Level	
off	No indicator lamp on
1	One indicator lamp on
2	Two indicator lamps on



- ① Seat heating switch

- ▶ Switch on ignition.

## Controls in detail

### Seats

#### *Switching on seat heating*

- ▶ Press switch ① twice.

A red indicator lamp above the switch comes on.

#### *Switching off seat heating*

- ▶ Press switch ① again.



The seat heating will be automatically switched off after approximately 30 minutes.

#### *Switching on rapid seat heating*

- ▶ Press switch ① once.

Both indicator lamps above the switch come on.



The system switches over to normal heating mode after approximately five minutes. Only the right-hand indicator lamp remains lit.

#### *Switching off rapid seat heating mode*

- ▶ Press switch ① twice.



If one or both of the lamps on the seat heating switch are flashing, there is insufficient voltage available since too many electrical consumers are turned on. The seat heating switches off automatically.

The seat heating will switch back on again automatically as soon as sufficient voltage is available.

#### Seat ventilation\*

The switch is located on the door. Seat ventilation can be activated manually with the SmartKey in starter switch position **1** or **2** (▷ page 31). The driver's seat ventilation can be activated automatically by the summer opening feature (▷ page 197).

The blue indicator lamps on the switch show the ventilation level selected:

Level	
<b>3</b>	Three indicator lamps on
<b>2</b>	Two indicator lamps on
<b>1</b>	One indicator lamp on
<b>off</b>	No indicator lamp on



#### ① Seat ventilation switch

- ▶ Switch on ignition.

#### Switching on seat ventilation

- ▶ Press switch ①.

Three blue indicator lamps above the switch come on.

Continue pressing switch ① until the desired seat ventilation level is reached.

#### Switching off seat ventilation

- ▶ Press switch ① repeatedly until all indicator lamps go out.



The seat ventilation for the driver's seat is automatically set to the highest level if activated via summer opening feature (▷ page 197).



If one or all of the lamps on the seat ventilation switch are flashing, there is insufficient voltage since too many electrical consumers are switched on. The seat ventilation switches off automatically.

The seat ventilation will switch back on again automatically as soon as sufficient voltage is available.

## Controls in detail

### Seats

#### Rear seats

##### Power seat bench\*

The switches for adjusting the seat bench are located at the respective rear doors.



- ① Seat bench fore and aft adjustment
- ② Head restraint fold/place upright

##### Seat bench fore and aft adjustment

- ▶ Press switch forward or backward in direction of arrow ①.

##### Head restraint folding

- ▶ Press switch up or down in direction of arrow ②.

The head restraint is folded or placed upright.

For information on switching on seat heating\* and seat ventilation\*, see (▷ page 117) and (▷ page 114).

##### Individual power seats\*

The switches for adjusting the seats are located at the respective rear doors.

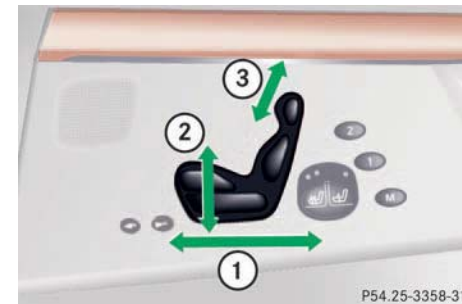

- ① Seat fore and aft adjustment
- ② Seat height
- ③ Head restraint fold/place upright

### **Seat fore and aft adjustment**

- ▶ Press switch forward or backward in direction of arrow ①.

### **Seat height**

- ▶ Press switch up or down in the direction of arrow ②.

### **Head restraint folding**

- ▶ Press switch up or down in direction of arrow ③.

The head restraint is folded or placed upright.

For information on switching on seat heating\* and seat ventilation\*, see (▷ page 117) and (▷ page 114).

### **Power seat, setting front passenger seat position from rear\***

This function lets you adjust the position of the front passenger seat from the rear.

#### **Warning!**



When adjusting the front passenger seat, make sure the seat, if occupied, is as far from the passenger front airbag as possible.

Otherwise, the passenger could be seriously or even fatally injured in the event of an accident or braking maneuver.

Make sure that no one is caught or injured while the seat is being adjusted.

The power seats can also be operated with the driver's or passenger door open. Do not leave children unattended in the vehicle, or with access to an unlocked vehicle. Unsupervised use of vehicle equipment may cause an accident and/or serious personal injury

## **Controls in detail**

### **Seats**

The switch is located on the right rear passenger door.



- ① Front passenger seat adjustment
- ② Rear seat adjustment
- ③ Seat height
- ④ Head restraint height
- ⑤ Backrest tilt
- ⑥ Seat fore and aft adjustment



## Controls in detail

### Seats

- ▶ Switch on ignition.
- or
- ▶ Open the right rear passenger door.
  - ▶ Press button ① to adjust the front passenger seat.



Adjusting the passenger seat position from the rear is not possible if you deactivate the operation of the rear door windows (▷ page 74).



Do not move the front passenger seat completely forward if objects are stored in the parcel net in the front passenger-side footwell. Items in the net may be damaged

#### ***Passenger seat fore and aft adjustment***

- ▶ Press the switch forward or backward in direction of arrow ⑥.

#### ***Passenger seat backrest tilt***

- ▶ Press the switch forward or backward in direction of arrow ⑤.

#### ***Passenger seat height***

- ▶ Press the switch up or down in the direction of arrow ③.

#### ***Passenger seat head restraint height***

- ▶ Press the switch up or down in direction of arrow ④.

Press button ② to adjust the rear seat (▷ page 119).

## ▼ Memory function



Prior to operating the vehicle, the driver should check and adjust the seat height, seat position fore and aft, and seat backrest angle if necessary, to ensure adequate control, reach, and comfort. The head restraint should also be adjusted for proper height. See also the section on airbags (> page 59) for proper seat positioning.

In addition, adjust the steering wheel to ensure adequate control, reach, operation and comfort. Both the inside and outside rear view mirrors should be adjusted for adequate rear vision.

Fasten seat belts. Infants and small children should be seated in a properly secured restraint system that complies with U.S. Federal Motor Vehicle Safety Standards 213 and 225 and Canadian Motor Vehicle Safety Standards 213 and 210.2.

You can store up to three different settings per SmartKey or SmartKey with KEYLESS-GO\*.

The following settings are saved for each stored position:

- Seat and backrest position
- Settings for the multicontour seat\*
- Steering wheel position
- Exterior rear view mirror position
- Automatic climate control

These key-dependent memory settings can be deactivated if desired (> page 160).

### Warning!



Do not activate the memory function while driving. Activating the memory function while driving could cause the driver to lose control of the vehicle.

## Controls in detail

### Memory function

The memory button and stored position switch are located on the door.

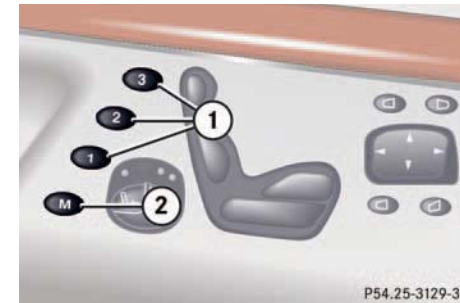

- ① Stored position buttons
- ② Memory button

- Make sure the ignition is switched on or the relevant door is open and the SmartKey is inserted in the starter switch.

## Controls in detail

### Memory function

#### Storing positions into memory

- ▶ Adjust the seats, steering wheel and exterior rear view mirrors to the desired position (▷ page 34).
- ▶ Press memory button ②.
- ▶ Release memory button ② and push one of the position buttons ① within three seconds.

All the settings are stored with the selected position.

#### Recalling positions from memory

- ▶ Press and hold one of the position buttons ① until the seat, steering wheel and exterior rear view mirrors have fully moved to the stored positions.



Releasing the button immediately stops movement to the stored positions.

#### Warning!



Do not operate the power seats using the memory button if the seat backrest is in an excessively reclined position. Doing so could cause damage to front or rear seats.

First move seat backrest to an upright position.

#### Storing exterior rear view mirror parking position

For easier parking, you can adjust the passenger-side exterior rear view mirror so that you can see the right rear wheel as soon as you engage reverse gear **R**.

For information on activating the parking position, see “Setting parking position for exterior rear view mirror” (▷ page 162).



You can store a parking position for the passenger-side exterior rear view mirror for each SmartKey or SmartKey with KEYLESS-GO\*.



- ① Passenger-side exterior rear view mirror button
- ② Adjustment button
- M** Memory button

- ▶ Stop the vehicle.
- ▶ Switch on ignition.
- ▶ Press button ①.  
The passenger-side exterior rear view mirror is selected.
- ▶ Adjust the passenger-side exterior rear view mirror with button ② so that you see the rear wheel and the road curb.
- ▶ Press memory button **M**.

## Controls in detail

### Memory function

- ▶ Within three seconds, press bottom of adjustment button ② on ▼.

The parking position is stored if the mirror does not move.



If the mirror does move, repeat the above steps. After the setting is stored, you can move the mirror again.

## Controls in detail

### Lighting

#### ▼ Lighting

For information on how to switch on the headlamps and use the turn signals, see “Switching on headlamps” (▷ page 47).





If you drive in countries where vehicles drive on the other side of the road than the country in which the vehicle is registered, you must have the headlamps modified for symmetrical low beams. Relevant information can be obtained at your authorized Mercedes-Benz Center.

#### Exterior lamp switch

The exterior lamp switch is located on the dashboard to the left of the steering wheel.



- 0** Off
- AUTO** Automatic headlamp mode
-  Parking lamps (also side marker lamps, tail lamps, license plate lamps, instrument panel lamps)  
Canada only: When engine is running, the low beam is also switched on.
-  Parking lamps plus low beam or high beam headlamps (combination switch pushed forward).
- P** → Standing lamps, right (turn left one stop)
- ← P** Standing lamps, left (turn left two stops)



If you remove the SmartKey and open the driver's door while the parking lamps or low beam headlamps are switched on, then:

- a warning sounds
-  appears in the multifunction display.
- the message SWITCH OFF LIGHTS! appears in the multifunction display



With the daytime running lamp mode activated and the engine running, the low beam headlamps cannot be switched off manually.

To activate the daytime running lamp mode, see "Setting daytime running lamp mode (USA only)" (▷ page 156).

### Manual headlamp mode

The low beam headlamps and parking lamps can be switched on and off with the exterior lamp switch. For exterior lamp switch, see (▷ page 124).

### Automatic headlamp mode

The parking lamps, low beam headlamps and license plate lamps switch on and off automatically depending on the brightness of the ambient light.

- ▶ Turn the exterior lamp switch to **AUTO**.

### Warning!





If the exterior lamp switch is set to **AUTO**,

- the headlamps may switch off unexpectedly when the system senses bright ambient light, for example light from oncoming traffic.
- the headlamps will not be automatically switched on under foggy conditions.

## Controls in detail

### Lighting

To minimize risk to you and to others, activate headlamps by turning exterior lamp switch to  when driving or when traffic and /or ambient lighting conditions require you to do so.

In low ambient lighting conditions, only switch from position **AUTO** to  with the vehicle at a standstill. Switching from **AUTO** to  will briefly switch off the headlamps. Doing so while driving in low ambient lighting conditions may result in an accident.

The automatic headlamp feature is only an aid to the driver. The driver is responsible for the operation of the vehicle's lights at all times.

## Controls in detail

### Lighting



With the daytime running lamp mode activated, the low beam headlamps will not switch off automatically.



The front fog lamps and rear fog lamp cannot be switched on manually with exterior lamp switch in position **AUTO**. To activate the fog lamps, turn exterior lamp switch to position  and pull the exterior lamp switch to first or second stop (> page 127).

#### Daytime running lamp mode

- ▶ Turn exterior lamp switch to position **0** or **AUTO**.

When the engine is running, the low beam headlamps are automatically switched on. In low ambient light conditions, the parking lamps will also switch on.

#### Canada only

When you shift from a driving position to position **N** or **P**, the low beam switches off (with a three-minute delay).

For nighttime driving you should turn the exterior lamp switch to position  to permit activation of the high beam headlamps.

#### USA only

The high beam headlamps can also be activated when driving with the daytime running lamp mode activated and exterior lamp switch in position **0**.

To activate the daytime running lamp mode, see “Setting daytime running lamp mode (USA only)” (> page 156).



See notes on the exterior lamp switch (> page 124).



#### Locator lighting and night security illumination

Locator lighting and night security illumination are described in the control system section under “Setting locator lighting” (> page 156) and “Setting night security illumination” (> page 157).

## Switching on fog lamps

### Warning!



In low ambient lighting or foggy conditions, only switch from position **AUTO** to  with the vehicle at a standstill. Switching from **AUTO** to  will briefly switch off the headlamps. Doing so while driving in low ambient lighting conditions may result in an accident.



Fog lamps will operate with the parking lamps and/or the low beam headlamps on. Fog lamps should only be used in conjunction with low beam headlamps. Consult your State or Province Motor Vehicle Regulations regarding permissible lamp operation.



The front fog lamps and rear fog lamp cannot be switched on manually with exterior lamp switch in position **AUTO**. To activate the fog lamps, turn exterior lamp switch to position  and pull the exterior lamp switch to first or second stop (> page 124).

### Switching on front fog lamps

- ▶ Make sure the low beam headlamps are switched on.
- ▶ Pull out exterior lamp switch to first stop.

The green indicator lamp  in the lamp switch comes on.

## Controls in detail

### Lighting

### Switching on rear fog lamp

- ▶ Make sure the low beam headlamps are switched on.
- ▶ Pull out exterior lamp switch to second stop.

The yellow indicator lamp  in the lamp switch comes on.



## Controls in detail

### Lighting

#### Combination switch

The combination switch is located on the left side of the steering column.

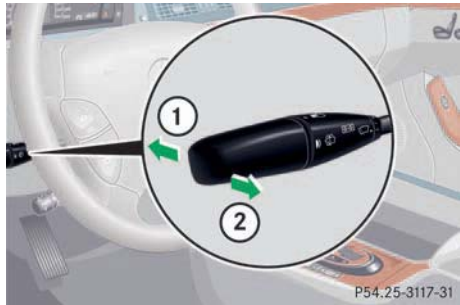

- ① High beam
- ② High beam flasher

#### Switching on high beams

- ▶ Turn exterior lamp switch to position  or to **AUTO** (▷ page 124).
- ▶ Push the combination switch in direction ①.

The high beam indicator  on the instrument cluster comes on (▷ page 22).

#### High beam flasher

- ▶ Pull the combination switch briefly in direction ②.

#### Hazard warning flasher

The hazard warning flasher can be activated with the starter switched on or off. It is activated automatically when an airbag is deployed.

The switch is located on the center console.



- ① Hazard warning flasher switch

#### Switching on the hazard warning flasher

- ▶ Press hazard warning flasher switch. All turn signals will flash.



With the hazard warning flasher activated and the combination switch set for either left or right turn, only the respective left or right turn signals will operate when the SmartKey in the starter switch is in position **1** or **2**.

#### Switching off the hazard warning flasher

- ▶ Press hazard warning flasher switch again.



If the hazard warning flasher was activated automatically, press switch **1** twice.

#### Interior lighting

The controls are located in the overhead control panel.



- ① Left front reading lamp
- ② Rear interior lamps
- ③ Right front reading lamp
- ④ Rocker switch for automatic control system

#### Activating automatic control

- ▶ Press rocker switch **4** to the center position.

Interior lamps are switched on in darkness, even when you:

- unlock the vehicle
- open a door
- remove the SmartKey from the starter switch

The interior lamps are switched off after a present time (▷ page 158).



If the door remains open, the interior lamps switch off automatically after approximately five minutes, when the SmartKey is removed or in the switch position **0**.

## Controls in detail

### Lighting

#### Deactivating automatic control

- ▶ Press the  symbol on rocker switch ④.

The interior lighting remains switched off in darkness, even when you:

- unlock the vehicle
- open a door
- remove the SmartKey from the starter switch

#### Manual control

#### Switching front interior lamps on and off

- ▶ Press the  symbol on rocker switch ④.

The front interior lighting switches on.

- ▶ Press the  symbol on rocker switch ④ again.

The interior lighting switches off. The automatic control function is activated.

#### Switching rear interior lamps on and off

- ▶ Press switch ② on the  symbol.

The rear compartment lighting is switched on.

- ▶ Press switch ② on the  symbol again.

The rear compartment lighting is switched off.

#### Switching front reading lamps on and off

- ▶ Press switch ① or ③.

The corresponding reading lamp is switched on.

- ▶ Press switch ① or ③ again.

The corresponding reading lamp is switched off.

#### Courtesy lighting

For better orientation in the dark, courtesy lamps will illuminate the interior of your vehicle as follows:

With parking lamps switched on:

- the door entry lamps
- the driver and passenger footwells

With SmartKey in starter switch position 1:

- the door entry lamps
- the center console



If you turn the SmartKey in the starter switch to position 0 and switch off the exterior headlamps, the door entry lamps will remain lit for approximately five minutes.

## ▼ Instrument cluster

A full view illustration of the instrument cluster can be found in the “At a glance” section of this manual (▷ page 22).

The instrument cluster is activated when you:

- open a door
- turn on the ignition
- press the reset button (▷ page 22)
- switch on the exterior lamps

You can change the instrument cluster settings in the instrument cluster submenu of the control system (▷ page 154).

### Instrument cluster illumination



- ① Knob for adjusting instrument cluster illumination

Use knob ① to adjust the illumination brightness for the instrument cluster.



The instrument cluster illumination is dimmed or brightened automatically to suit ambient light conditions.

The instrument cluster illumination will also be adjusted automatically when you switch on the vehicle’s exterior lamps.

## Controls in detail

### Instrument cluster

- ▶ Press knob ①.  
The knob will pop out.

#### To brighten illumination

- ▶ Turn knob ① in the instrument cluster clockwise.  
The instrument cluster illumination will brighten.

#### To dim illumination

- ▶ Turn knob ① in the instrument cluster counterclockwise.  
The instrument cluster illumination will dim.

## Controls in detail

### Instrument cluster

#### Coolant temperature gauge

##### Warning!



- Driving when your engine is badly overheated can cause some fluids which may have leaked into the engine compartment to catch fire. You could be seriously burned.
- Steam from an overheated engine can cause serious burns and can occur just by opening the hood. Stay away from the engine if you see or hear steam coming from it.

Turn off the engine, get out of the vehicle and do not stand near the vehicle until the engine has cooled down.





Excessive coolant temperature triggers a warning in the multifunction display (▷ page 323).

During severe operating conditions, e.g. stop-and-go traffic, the coolant temperature may rise close to 248°F (120°C), i.e. close to the red zone of the temperature gauge.

The engine should not be operated with the coolant temperature above 248°F (120°C), i.e. in the red zone of the coolant temperature gauge. Doing so may cause serious engine damage which is not covered by the Mercedes-Benz Limited Warranty.

#### Trip odometer

- ▶ Make sure you are viewing the trip odometer display.
- ▶ If it is not displayed, press the  or  button on the multifunction steering wheel repeatedly until the trip odometer appears (▷ page 134).
- ▶ Press and hold reset button on the instrument cluster (▷ page 22) until the trip odometer is reset.

#### Tachometer

The red marking on the tachometer denotes excessive engine speed.



Avoid driving at excessive engine speeds, as it may result in serious engine damage that is not covered by the Mercedes-Benz Limited Warranty.

To help protect the engine, the fuel supply is interrupted if the engine is operated within the red marking.

#### S 55 AMG

The tachometer of the S 55 AMG does not have a red marking denoting excessive engine speed.

To help protect the engine, the fuel supply is interrupted if the engine is operated at an excessive engine speed.

#### Outside temperature indicator

##### Warning!



The outside temperature indicator is not designed to serve as an ice-warning device and is therefore unsuitable for that purpose.

Indicated temperatures just above the freezing point do not guarantee that the road surface is free of ice. The road may still be icy, especially in wooded areas or on bridges.

The outside temperature is displayed in the instrument cluster (▷ page 22). For information on how to select the unit of the displayed temperature, i.e. degrees Celsius (°C) or degrees Fahrenheit (°F), see “Selecting temperature display mode” (▷ page 154).

The temperature sensor is located in the front bumper area. Due to its location, the sensor can be affected by road or engine heat during idling or slow driving. Therefore, the accuracy of the displayed temperature can only be verified by comparison to a thermometer placed next to the sensor, not by comparison to external displays (e.g. bank signs, etc.).

When moving the vehicle into colder ambient temperatures (e.g. when leaving your garage), you will notice a delay before the lower temperature is displayed.

A delay also occurs when ambient temperatures rise. This prevents inaccurate temperature indications caused by heat radiated from the engine during idling or slow driving.

## Controls in detail

### Control system

#### ▼ Control system

The control system is activated as soon as the SmartKey in the starter switch is turned to position **1** or as soon as the KEYLESS-GO start/stop button\* is in position **1**. The control system enables you to:

- call up information about your vehicle
- change vehicle settings

For example, you can use the control system to find out when your vehicle is next due for service, to set the language for messages in the instrument cluster display, and much more.



The displays for the audio systems (radio, CD player) will appear in English, regardless of the language selected.

#### Warning!



A driver's attention to the road and traffic conditions must always be his/her primary focus when driving.

For your safety and the safety of others, selecting features through the multifunction steering wheel should only be done by the driver when traffic and road conditions permit it to be done safely.

Bear in mind that at a speed of just 30 mph (approximately 50 km/h), your vehicle is covering a distance of 44 feet (approximately 14 m) every second.

The control system relays information to the multifunction display.

### Multifunction display

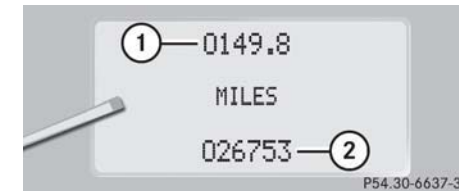

- ① Trip odometer
- ② Main odometer

### Multifunction steering wheel

The displays in the multifunction display and the settings in the control system are controlled using the buttons on the multifunction steering wheel.



## Controls in detail

### Control system

- ① Multifunction display in the speedometer

#### Operating the control system

- ② Selecting the submenu or setting the volume

**+** up / to increase

**-** down / to decrease

- ③ Telephone\*

 to take a call

 to end a call

- ④ Menu systems

 for next menu

 for previous menu

- ⑤ Moving within a menu

 for next display

 for previous display



## Controls in detail





### Control system

Pressing any of the buttons on the multifunction steering wheel will alter what is shown in the multifunction display.

The information available in the multifunction display is arranged in menus, each containing a number of functions or submenus.

The individual functions are then found within the relevant menu (radio or CD operations under **AUDIO**, for example). These functions serve to call up relevant information or to customize the settings for your vehicle.

It is helpful to think of the menus, and the functions within each menu, as being arranged in a circular pattern.

- If you press button  or  repeatedly, you will pass through each menu one after the other.
- If you press button  or  repeatedly, you will pass through each function display, one after the other, in the current menu.

In the **SETTINGS** menu, instead of functions you will find a number of submenus for calling up and changing settings. For instructions on using these submenus, see “Settings menu” (▷ page 151).

The number of menus available in the system depends on which optional equipment is installed in your vehicle.

The menus are described on the following pages.

Menus

This is what you will see when you scroll through the menus.

The table on the next page provides an overview of the individual menus.

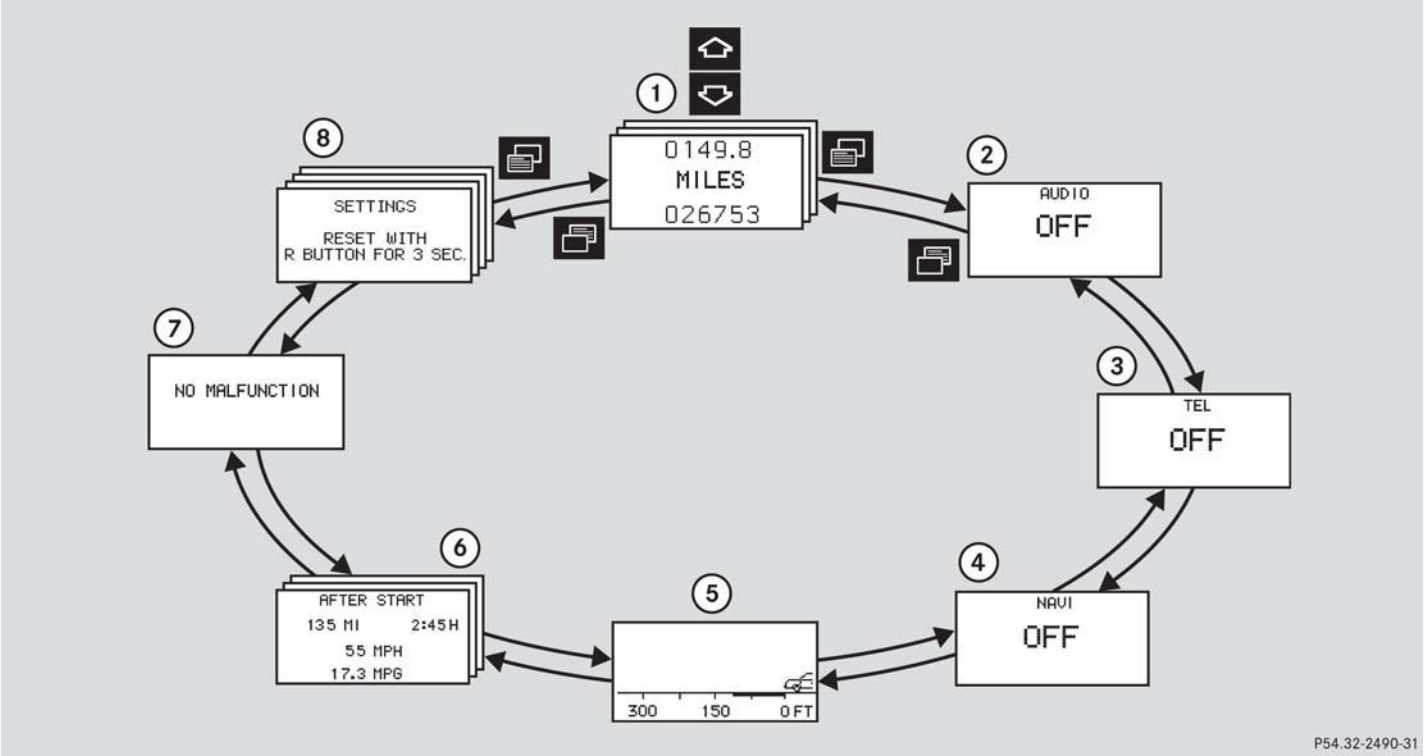

## Controls in detail

### Control system

#### Menus, submenus and functions

	Menu ①	Menu ②	Menu ③	Menu ④	Menu ⑤	Menu ⑥	Menu ⑦	Menu ⑧
	Standard display	AUDIO	Telephone*	NAVI	Distronic*	Trip computer	Malfunction memory	Settings
Commands/submenus	Call up FSS	Select radio station	Load phone book	Activate route guidance	Call up settings	Fuel consumption statistics after start	Call up malfunction messages	Reset to factory settings
	Check tire pressure*	Select satellite radio station* (USA only)	Search for name in phone book			Fuel consumption statistics since the last reset		Instrument cluster submenu
	Check engine oil level	Operate CD player	Select number last dialed			Call up range		Lighting submenu
	Digital speedometer	Operate cassette player						Vehicle submenu Convenience submenu



The headings used in the menus table are designed to facilitate navigation within the system and are not necessarily identical to those shown in the control system displays.

The first function displayed in each menu will automatically show you which part of the system you are in.

#### Standard display menu

You can select the functions in the standard display menu with button or .

The following functions are available:

Funktion	Page
Call up FSS	295
Check tire pressure*	287
Check engine oil level	274
Call up digital speedometer	139

#### Display digital speedometer

- Press the or button repeatedly until you see the digital speedometer appear in the display.

The current vehicle speed is shown in the multifunction display.

#### AUDIO menu

The functions in the AUDIO menu operate the audio equipment which you currently have turned on.

If no audio equipment is currently turned on, the message AUDIO OFF is shown in the display.



The following functions are available:

Funktion	Page
Select radio station	140
Select satellite radio* station (USA only)	140
Operate CD player	141
Operate cassette player	141

## Controls in detail

### Control system

#### Select radio station

- ▶ Turn on the radio. Refer to separate COMAND operating instructions.
- ▶ Press button  or  repeatedly until you see the currently tuned station in the display.



- ① Waveband
- ② Station frequency

- ▶ Press button  or  repeatedly until the desired station is found.





You can only store new stations using the corresponding feature on the radio. Refer to separate COMAND operating instructions.

You can also operate the radio in the usual manner.

#### Select satellite radio\* station (USA only)

The satellite radio is treated as a radio application.

- ▶ Select satellite radio with the corresponding key on the COMAND control panel (SAT).
- ▶ Press button  or  repeatedly until you see the currently tuned station in the display.

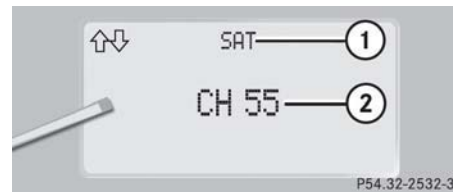

- ① SAT mode and preset number
- ② Channel name or number

- ▶ Press button  or  repeatedly until the desired channel is found.



Feature description is based on preliminary information available at time of printing.



Additional optional satellite radio equipment and a subscription to satellite radio service provider are required for satellite radio operation. At time of printing, no date for the availability of optional equipment required for satellite radio operation had been set. Contact an authorized Mercedes-Benz Center for details and availability for your vehicle.

For more information, refer to separate COMAND operating instructions.

## Controls in detail

### Control system

#### Operate the CD player

- ▶ Turn on the radio and select the CD player. Refer to separate COMAND operating instructions.
- ▶ Press button  or  repeatedly until the settings for the CD currently being played appear in the display.





- ① Current CD  
(for CD changer\* (▶ page 142))
- ② Current track

- ▶ Press button  or  repeatedly until the desired track is selected.





CD changer\*: To select a CD from the magazine, press a number on the COMAND system key pad located in the center dashboard.

#### Operate the cassette player

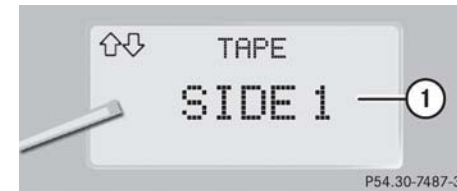
- ▶ Turn on COMAND and select cassette player. Please refer to the separate operating instructions.
- ▶ Press button  or  repeatedly until you see the settings for the cassette being played in the display.



- ① Current side
- ▶ Press button  to fast forward or  to rewind.

## Controls in detail

### Control system

#### CD changer\* operating mode

##### General notes

Should excessively high temperatures occur while in CD mode, CD TEMP HIGH will appear on the display and muting will take place. The unit will then switch back to the last operating mode used until the temperature has decreased to a safe operating level.

Should excessively low temperatures occur while in CD mode, CD TEMP LOW will appear on the display, but the CD will continue to play.

Handle CDs carefully to prevent interference during playback. Avoid fingerprints and dust on CDs. Do not write on CDs or apply any label or other material to them.

Only use original CDs. Using copied CDs may create problems during playback.

Clean CDs from time to time with a commercially available cleaning cloth. No solvents, anti-static sprays, etc. should be used for cleaning. Replace the CD in its case after use. Protect CDs from heat and direct sunlight.



Only use CDs, which bear the label shown and that conform to the compact disc digital audio standard (IEC 60908).

Use of CDs which do not meet this standard may cause damage to the CD changer. Do not play single-CDs (80 mm) with an adapter.



Your CD drive has been designed to play CDs which correspond to the IEC 60908 standard.

If you insert thicker data carriers, e.g. ones that have data on both sides (one side with DVD data, the other side with audio data), they cannot be ejected and will damage the drive.

For information on operating the CD changer, refer to the separate COMAND operating instructions.

### Warning!



The CD changer is a Class 1 laser product. There is a danger of invisible laser radiation if the cover is opened or damaged. Do not remove the cover. The CD changer does not contain any parts which can be serviced by the user. For safety reasons, have any service work which may be necessary performed only by qualified personnel.

### Operational readiness of CD changer

If a CD changer has been installed in the system, it can be operated from the COMAND system key pad located in the center dashboard. A loaded magazine must be installed for CD playing.

### Loading/unloading the CD magazine

The CD changer is located behind the cover on the left hand side in the trunk.

- ▶ Remove the CD changer cover.
- ▶ Slide the CD changer door to the right and press the eject button **EJ**.
- ▶ The magazine is ejected.

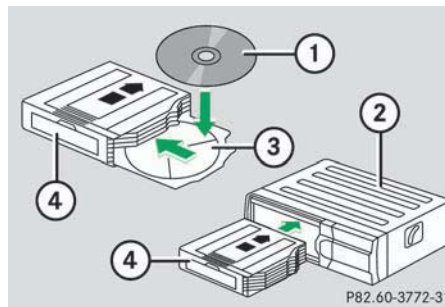

- ① CD
- ② CD changer
- ③ CD tray
- ④ CD magazine

## Controls in detail

### Control system

- ▶ Remove the magazine and completely pull out the CD tray.
- ▶ Place the CD in the recess of the tray, label side up.
- ▶ Push the tray into the magazine in the direction shown by the arrow.



CDs which have been inserted improperly or are unreadable will not be played.

- ▶ Push the magazine into the CD changer in the direction shown by the arrow and close the CD changer door.



## Controls in detail

### Control system

#### TEL menu\*

##### Warning!





A driver's attention to the road must always be his/her primary focus when driving. For your safety and the safety of others, we recommend that you pull over to a safe location and stop before placing or taking a telephone call. If you choose to use the telephone while driving, please use the hands-free device and only use the telephone when weather, road and traffic conditions permit.

Some jurisdictions prohibit the driver from using a cellular telephone while driving a vehicle.

Bear in mind that at a speed of just 30 mph (approximately 50 km/h), your vehicle is covering a distance of 44 feet (approximately 14 m) every second.

Never operate radio transmitters equipped with a built-in or attached antenna (i.e. without being connected to an external antenna) from inside the vehicle while the engine is running. Doing so could lead to a malfunction of the vehicle's electronic system, possibly resulting in an accident and/or personal injury.

You can use the functions in the TEL menu to operate your telephone, provided it is connected to a hands-free system and switched on.

- ▶ Switch on the telephone and COMMAND.
- ▶ Press button  or  on the steering wheel repeatedly until you see the TEL menu in the display.

Which messages will appear in the display field depends on whether your telephone is switched on or off:

- If the telephone is off, the message in the multifunction display is: TEL OFF.
- If the telephone is on:

The telephone will then search for a network. During this time the display reads NO SERVICE.

As soon as the telephone has found a network, READY is indicated in the display.

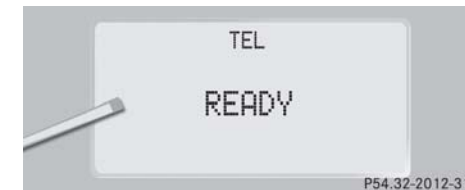

The standby message indicates that your telephone is ready for use and you can operate it using the control system.

The following functions are available:

Function	Page
Answering a call	145
Ending a call	145
Dialing a number from the phone book	145
Redialing	146

### Answering a call

When your telephone is ready to receive calls, you can answer a call at any time. In the display you will then see the message:



- ▶ Press button .

You have answered the call. In the display you see the duration of the call positioned above the number.



If you do not wish to accept a call, press button .

## Controls in detail

### Control system





### Ending a call

- ▶ Press button .

You have ended the call. In the display you will again see the standby message.

### Dialing a number from the phone book



If your telephone is ready to receive calls, you may select and dial a number from the phone book at any time.

- ▶ Press button  or  repeatedly until you see the TEL menu in the display.
- ▶ Press button  or .

The control system reads the phone book which is stored in the telephone. The call transmission depends on the number of entries in the phone book and can take up to 60 seconds. In the display you will see the message PLEASE WAIT!. ▷▷



## Controls in detail

### Control system

- ▷▷ When the message PLEASE WAIT! disappears, the phone book has been loaded.
- ▶ Press button  or  repeatedly until the desired name appears in the display.

The stored names are displayed in ascending or descending alphabetical order.



If you press and hold  or  for longer than one second, the system scrolls rapidly through the list of names until you release the button again.

Cancel the quick search mode by pressing .

- ▶ Press button .

The system dials the selected phone number.

- If the connection is successful, the name of the party you called and the duration of the call will appear in the display.

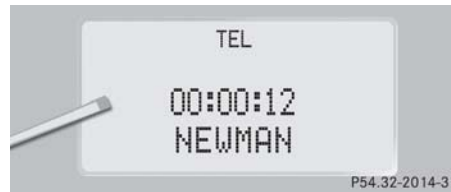

- If no connection is made, the control system stores the dialed number in the redial memory.



### Redialing

The control system stores the most recently dialed phone numbers. This eliminates the need to search through your entire phone book.

- ▶ Press button  or  repeatedly until you see the TEL menu in the display.

- ▶ Press button .

In the display you see the first number in the redial memory.

- ▶ Press button  or  repeatedly until the desired name appears in the display.



If you do not want to use the telephone, press button .

- ▶ Press button .



The control system dials the selected phone number.

## Controls in detail

### Control system

#### NAVI menu

In the NAVI menu, you will see which status the navigation system has.



- ▶ Press button  or  repeatedly until you see the message NAVI in the display.
- If the navigation system is switched off, the message NAVI OFF is shown in the display.
- If the navigation system is on and no destination has been entered, you will see the current direction in which the vehicle is moving and the names of streets in the display.

Please refer to the COMAND manual for instructions on how to activate the route guidance system.

#### Distronic\* menu

Use the DISTRONIC menu to display the current settings for your Distronic system. What information is shown in the display depends on whether the Distronic system is active or inactive.

Please refer to the “Driving systems” section of this manual (▷ page 206) for instructions on how to activate Distronic.

- ▶ Press button  or  repeatedly until you see one of the following two pictures in the display.

#### Distronic deactivated

When Distronic is deactivated you will see the standard display in the display.

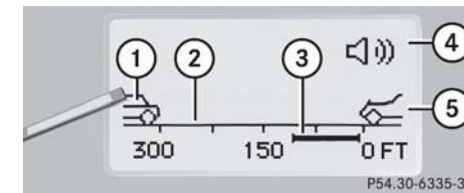

- ① Vehicle ahead, if detected
- ② Actual distance to vehicle ahead
- ③ Preset distance threshold to vehicle ahead
- ④ Symbol for activated distance warning function
- ⑤ Your vehicle

## Controls in detail

### Control system

#### Distronic activated

When you activate Distronic, you will see the set speed for about five seconds in the Distronic display. The following display then appears:

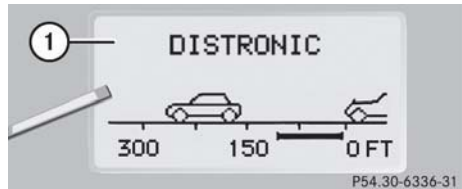





① Distronic activated

#### Trip computer menu

Use the trip computer menu to call up statistical data on your vehicle. The following information is available:

Function	Page
Fuel consumption statistics after start	148
Fuel consumption statistics since last reset	149
Resetting fuel consumption statistics	149
Call up range (distance to empty)	150

#### Fuel consumption statistics after start

- ▶ Press button  or  repeatedly until you see the first function of the Trip computer menu.
- ▶ Press button  or  repeatedly until you see this message in the left display: AFTER START.

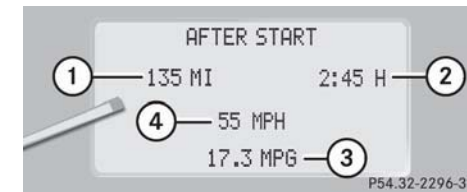

- ① Distance driven since start
- ② Time elapsed since start
- ③ Average fuel consumption since start
- ④ Average speed since start



The AFTER START display will flash until a distance of approximately 1 mile (1.6 km) has been covered or two minutes have elapsed since the engine was restarted. During this period, you can incorporate the values for the previous journey by pressing the reset button on the instrument cluster.

If the reset button is not pressed, the AFTER START values are set to 0.

#### Fuel consumption since last reset

- ▶ Press button or repeatedly until you see the first function of the trip computer menu.
- ▶ Press button or repeatedly until you see this message in the display: AFTER RESET.

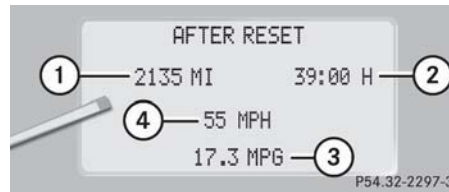

- ① Distance driven since last reset
- ② Time elapsed since last reset
- ③ Average fuel consumption since last reset
- ④ Average speed since last reset





#### Resetting fuel consumption statistics

- ▶ Press button or repeatedly until you see the first function of the Trip computer menu.
- ▶ Press button or repeatedly until you see the reading that you want to reset in the display.
- ▶ Press and hold the reset button on the instrument cluster (▷ page 22) until the value is reset to 0.

## Controls in detail

### Control system

#### Call up range (distance to empty)

- ▶ Press button  or  repeatedly until you see the first function of the Trip computer menu.
- ▶ Press button  or  repeatedly until you see this message in the display: RANGE.

In the display you will see the calculated range based on the current fuel tank level.

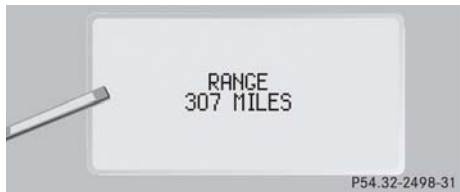



#### Malfunction memory menu

Use the malfunction memory menu to scan malfunction and warning messages that may be stored in the system. What information is shown in the display depends on whether malfunctions have actually occurred.

#### Warning!



Malfunction and warning messages are only indicated for certain systems and are intentionally not very detailed. The malfunction and warning messages are simply a reminder with respect to the operation of certain systems and do not replace the owner's and/or driver's responsibility to maintain the vehicle's operating safety by having all required maintenance and safety checks performed on the vehicle and by bringing the vehicle to an authorized Mercedes-Benz Center to address the malfunction and warning messages (> page 312).

- ▶ Press button  or  repeatedly until you see the malfunction message memory in the display.

#### No malfunction messages

If no malfunctions have occurred, the message in the display is:

NO MALFUNCTION

#### Malfunctions have occurred

If malfunctions have occurred, you will see the number of malfunctions in the display:



- ① Number of malfunctions

- ▶ Press button  or .

The stored messages will now be displayed in the order in which the malfunctions have occurred. See the “Practical hints” section for malfunction and warning messages (▷ page 312).



Should any malfunctions occur while driving, the number of malfunctions will reappear in the display when the SmartKey in the starter switch is turned to position **0** or removed from the starter switch.



The message memory will be cleared when you turn the SmartKey in the starter switch to position **1** or **2**. You will then only see high priority malfunctions (▷ page 312).

### Settings menu

In the **SETTINGS** menu there are two functions:

- The function **RESET WITH R BUTTON FOR 3 SEC.**, with which you can reset all settings to the original factory settings.
  - A collection of submenus with which you can make individual settings for your vehicle.
- ▶ Press button  or  repeatedly until the **SETTINGS** menu appears in the display.



### Resetting all settings

You can reset all the functions of all submenus to the factory settings.

- ▶ Press the reset button on the instrument cluster (▷ page 22) for approximately three seconds.

In the display you will see the request to press the reset button again to confirm.

- ▶ Press the reset button again.

The functions of all the submenus will reset to factory settings.



The settings you have changed will not be reset unless you confirm the action by pressing the reset button a second time.

Due to safety reasons, resetting all of the settings while driving will not reset all of the values in the **LIGHTING** or the **VEHICLE** menu.



## Controls in detail

### Control system

#### Submenus in the Settings menu



- ▶ Press button  or .



In the display you see the collection of the submenus.



- ▶ Press button  or .

The selection marker moves to the next submenu.

The submenus are arranged by hierarchy. Scroll down with the  button, scroll up with the  button.

Move within the submenus with the  or  button to the individual functions.

The settings themselves are made with button  or .

#### Resetting the functions of a submenu

For each submenu you can reset all the functions to the factory settings.

- ▶ Move to a function in the submenu.
- ▶ Press the reset button on the instrument cluster (▷ page 22) for approximately three seconds.

In the display you will see the request to press the reset button again to confirm.

- ▶ Press the reset button again.

All functions of the submenu will reset to factory settings.

## Controls in detail

### Control system

The table below shows what settings can be changed within the various menus. Detailed instructions on making individual settings can be found on the following pages.

<b>INSTRUMENT CLUSTER</b>	<b>LIGHTING</b>	<b>VEHICLE</b>	<b>CONVENIENCE</b>
Select temperature display mode	Set daytime running lamp mode (USA only)	Set automatic locking	Set key-dependency
Select multifunction display mode	Set locator lighting	Limiting opening height of trunk lid*	Activate easy-entry/exit feature
Select language	Exterior lamps delayed shut-off		Set parking position for exterior rear view mirror
	Interior lighting delayed shut-off		Set fold-in function for exterior rear view mirrors
			Adjusting the drive-dynamic seat (driver's side)

## Controls in detail

### Control system

#### Instrument cluster submenu

Access the INST. CLUS. submenu via the SETTINGS menu. Use the INST. CLUS. submenu to change the instrument cluster display settings. The following functions are available:

Function	Page
Select temperature display mode	155
Select multifunction display mode	154
Select language	155

#### Selecting temperature display mode

- ▶ Move the selection marker with the **+** or **-** button to the INST. CLUS. submenu.
- ▶ Press button **↕** or **↓** repeatedly until you see this message in the display: TEMP. INDICATOR.

The selection marker is on the current setting.

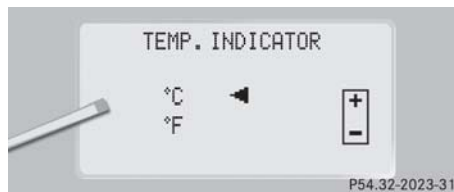

- ▶ Press **+** or **-** to set the temperature unit to degrees Celsius (°C) or degrees Fahrenheit (°F).

#### Selecting multifunction display mode

- ▶ Move the selection marker with the **+** or **-** button to the INST. CLUS. submenu.
- ▶ Press button **↕** or **↓** repeatedly until you see this message in the display: DISPLAY VALUES IN.

The selection marker is on the current setting.

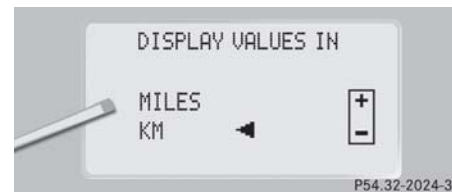

- ▶ Press **+** or **-** to set speedometer unit to MILES or KM.

## Controls in detail

### Control system

#### Selecting language

- ▶ Move the selection marker with the **+** or **-** button to the INST. CLUS. submenu.
- ▶ Press button **↶** or **↷** repeatedly until you see this message in the display: TEXT.

The selection marker is on the current setting.



- ▶ Press **+** or **-** to select the language to be used for the multifunction display messages.

Available languages:

- German
- English
- French
- Italian
- Spanish

#### Lighting submenu

Access the LIGHTING submenu via the SETTINGS menu. Use the LIGHTING submenu to change the lamp and lighting settings on your vehicle. The following functions are available:

Function	Page
Set daytime running lamp mode (USA only)	156
Set locator lighting	156
Exterior lamps delayed shut-off	157
Interior lighting delayed shut-off	158

## Controls in detail

### Control system

#### Setting daytime running lamp mode (USA only)

- ▶ Move the selection marker with the **+** or **-** button to the LIGHTING submenu.
- ▶ Press button **▲** or **▼** repeatedly until you see this message in the display: LIGHT CIRCUIT HEADLAMP MODE . The selection marker is on the current setting.



- ▶ Press **+** or **-** to select manual or daytime running lamp (constant) mode. This function is not available in countries where daytime running lamps are mandatory.

With daytime running lamp mode selected and the exterior lamp switch at position **0**, the following lamps will come on automatically when the engine is turned on:

- Parking lamps and low beam headlamps
- License plate lamps (in low ambient light conditions)



If you turn the exterior lamp switch to another position, the corresponding lamp(s) will switch on.

For safety reasons, resetting the LIGHTING submenu to factory settings (> page 152) while driving will not reset the daytime running lamp mode.

In the display you will then see the message: LIGHTING - CANNOT BE RESET COMPLETELY TO FACTORY SETTINGS WHILE DRIVING.

#### Setting locator lighting

During darkness, the following lamps will come on when the exterior lamp switch is in position **AUTO**, the locator lighting feature is activated, and the vehicle is unlocked by remote control:

- Parking lamps
- Tail lamps
- License plate lamps
- Front fog lamps

To activate locator lighting:

- ▶ Make sure the function LOCATOR LIGHTING is set.
- ▶ Turn the exterior lamp switch to position **AUTO**.

The locator lighting switches off when the driver's door is opened. It switches off automatically after a period of approximately 40 seconds.

- ▶ Move the selection marker with the **+** or **-** button to the LIGHTING submenu.

- ▶ Press button **↶** or **↷** repeatedly until you see this message in the display: LOCATOR LIGHTING.

The selection marker is on the current setting.



- ▶ Press **+** or **-** to select the desired setting.

The locator lighting will be switched ON or OFF.

### Setting night security illumination

(Exterior lamps delayed switch-off)

Use the HEADLAMPS DELAYED SWITCH-OFF function to set whether and for how long you would like the exterior lamps to illuminate during darkness after all doors are closed. When the delayed switch-off feature is activated and the exterior lamp switch is in position **AUTO** before the engine is turned off, the following lamps will remain lit after you remove the SmartKey from the starter switch:

- Parking lamps
- Tail lamps
- License plate lamps
- Front fog lamps

## Controls in detail

### Control system



You can reactivate this function within ten minutes by opening a door.

If you do not open a door after removing the SmartKey, the lamps will automatically switch off after 60 seconds.

To activate night security illumination:

- ▶ Select delayed switch-off period (see below).
- ▶ Turn the exterior lamp switch to position **AUTO** before turning off the engine.

To select delayed switch-off period:

- ▶ Move the selection marker with the **+** or **-** button to the LIGHTING submenu.
- ▶ Press button **↶** or **↷** repeatedly until you see this message in the display: HEADLAMPS DELAYED SWITCH-OFF.

The selection marker is on the current setting. >>

## Controls in detail

### Control system

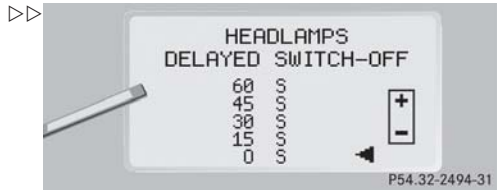

- ▶ Press **+** or **-** to select the desired lamp-on period.

You can select:

- 0 S, the delayed switch-off feature is deactivated
- 15 S, 30 S, 45 S, or 60 S, the delayed switch-off feature is activated

You can temporarily deactivate the delayed switch-off feature:

- ▶ Before leaving the vehicle, turn the SmartKey in the starter switch to position **0**.

- ▶ Turn the SmartKey in the starter switch to position **2** and back to **0**.

The delayed switch-off feature is deactivated. It will reactivate as soon as you reinsert the SmartKey in the starter switch.



Vehicles with KEYLESS-GO\*:

- ▶ Press the KEYLESS-GO start/stop button on the gear selector lever (> page 33).

#### **Interior illumination delayed switch-off**

Use this function to set whether and for how long you would like the interior lighting to remain lit during darkness after the SmartKey is removed from the starter switch.

- ▶ Move the selection marker with the **+** or **-** button to the LIGHTING submenu.

- ▶ Press button  or  repeatedly until you see this message in the display: INT. ILLUMINATION DELAYED SWITCH-OFF.

The selection marker is on the current setting.



- ▶ Press **+** or **-** to select the desired lamp-on time period. You can select:

- 0 S, the delayed switch-off feature is deactivated.
- 5 S, 10 S, 15 S, or 20 S, the delayed switch-off feature is activated.

## Controls in detail

### Control system

#### Vehicle submenu

Access the VEHICLE submenu via the SETTINGS menu. Use the VEHICLE submenu to make general vehicle settings. The following functions are available:

Function	Page
Setting automatic locking	159
Limiting opening height of trunk lid*	159

#### Setting automatic locking

Use this function to activate or deactivate the automatic central locking. With the automatic central locking system activated, the vehicle is centrally locked at vehicle speeds of approximately 9 mph (15 km/h).

- ▶ Press button **+** or **-** to move the selection marker to the VEHICLE submenu.
- ▶ Press button **▲** or **▼** repeatedly until you see this message in the display: AUTOMATIC DOOR LOCK.

The selection marker is on the current setting.



- ▶ Press **+** or **-** to switch AUTOMATIC DOOR LOCK ON or OFF.

#### Limiting opening height of trunk lid\*

This function is available on vehicles with the trunk lid opening/closing system\*. Use this function to activate or deactivate the limiting opening height of trunk lid.

- ▶ Move the selection marker with the **+** or **-** button to VEHICLE submenu.
- ▶ Press button **▲** or **▼** repeatedly until you see this message in the display:

OPENING LIMITER  
TRUNK LID

The selection marker is on the current setting.



- ▶ Press button **+** or **-** to switch the opening limiter for trunk lid ON or OFF.



## Controls in detail

### Control system



#### Convenience submenu

Access the CONVENIENCE submenu via the SETTINGS menu. Use the CONVENIENCE submenu to change the settings for a number of convenience features. The following functions are available:

Function	Page
Setting key-dependency	160
Activating easy-entry/exit feature	160
Setting parking position for exterior rear view mirror	162
Setting fold-in function for exterior rear view mirrors	162
Adjusting the drive-dynamic seat (driver's side)	163

#### Setting key-dependency

Use this function to set whether the memory settings for the seats, the steering wheel, the mirrors, and the automatic climate control should be stored separately for each SmartKey (▷ page 121).

- ▶ Move the selection marker with the **+** or **-** button to the CONVENIENCE submenu.
- ▶ Press button  or  repeatedly until you see this message in the display: SETTINGS KEY-DEPENDENT.

The selection marker is on the current setting.



- ▶ Press **+** or **-** to set key-dependency to ON or OFF.

#### Activating easy-entry/exit feature

Use this function to activate and deactivate the easy-entry/exit feature. When the feature is activated, the steering wheel and driver's seat will move back to facilitate exiting when you:

- remove the SmartKey from the starter switch or the KEYLESS-GO start/stop button\*
- open the driver's door

However, the engine must be turned off.

#### Warning!



You must make sure that no one can become trapped or injured by the moving steering wheel and the driver's seat when the easy-entry/exit feature is in operation and the driver's door is being opened or the SmartKey is removed from the starter switch.

Do not leave children unattended in the vehicle, or with access to an unlocked vehicle. Children could open the driver's door and unintentionally activate the easy-entry/exit feature, which could result in an accident and/or serious personal injury.

After entering the vehicle, the steering wheel and seat will move into the position stored in memory when:

- the driver's door is closed
- you put the SmartKey in the starter switch
- press and hold the appropriate stored position button on the memory switch (▷ page 121)



To cancel seat/steering wheel movement, do one of the following:

- Press seat adjustment switch (▷ page 35)
- Move the steering column stalk (▷ page 37)
- Press the memory button (▷ page 121)

- ▶ Move the selection marker with the **+** or **-** button to the CONVENIENCE submenu.
- ▶ Press button **▲** or **▼** repeatedly until you see this message in the display: EASY-ENTRY FEATURE ACTIVATE. The selection marker is on the current setting.

## Controls in detail

### Control system



- ▶ Press **+** or **-** to change the easy-entry/exit setting.

The following settings are available for the easy-entry/exit feature:

STEER. COL.	Only the steering column is moved.
ST. COL + SEAT	Both the steering column and the seat are moved.
OFF	The easy-entry/exit feature is deactivated.

## Controls in detail

### Control system

#### **Setting parking position for exterior rear view mirror**

Use the MIRROR SETTING WHEN PARKING function to select whether the passenger-side exterior rear view mirror should be turned downward during parking maneuvers when reverse gear **R** is engaged. For additional information, see “Activating exterior rear view mirror parking position” (▷ page 175).

- ▶ Move the selection marker to the CONVENIENCE submenu using the **+** or **-** button.
- ▶ Press button **↕** or **↓** repeatedly until you see this message in the display: MIRROR SETTING WHEN PARKING.

The selection marker is on the current setting.



- ▶ Press **+** or **-** to switch function ON or OFF.

#### **Setting fold-in function for exterior rear view mirrors**

Using this function, you can set the exterior rear view mirrors to be automatically folded in when you lock your vehicle (▷ page 176).

- ▶ Move the selection marker to the CONVENIENCE submenu with the **+** or **-** button.

- ▶ Press button **↕** or **↓** repeatedly until the message FOLD IN MIRRORS WHEN LOCKING? appears in the display.

The selection marker is on the current setting.



- ▶ Press button **+** or **-** to switch the automatic fold-in setting for the mirrors ON or OFF when the vehicle is locked.

## Controls in detail

### Control system

#### **Adjusting drive-dynamic seats**

Use this function to adjust the settings for the drive-dynamic seat.

- ▶ Move the selection marker with the **+** or **-** button to the CONVENIENCE submenu.
- ▶ To adjust the driver's drive-dynamic seat press button **▲** or **▼** repeatedly until you see this message in the display: DRIV. DYN. SEAT ADJ. DRIVER

The selection marker is on the current setting.

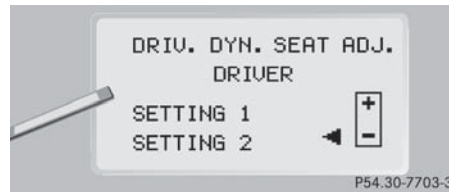

- ▶ Press button **+** or **-** to select the desired setting.

The following settings are available:

Setting 1	(Sporty) Strong lateral support and fast air pressure build-up in the air chambers of the backrest side bolsters
Setting 2	(Comfort) Less lateral support and slow air pressure build-up in the air chambers of the backrest side bolsters

## Controls in detail

### Automatic transmission

#### ▼ Automatic transmission

For more information on driving with an automatic transmission, see the “Getting started” section (▷ page 43).

Your vehicle’s transmission adapts its gear shifting process to your individual driving style by continually adjusting the shift points up or down. These shift point adjustments are performed based on current operating and driving conditions.

If the operating conditions change, the automatic transmission reacts by adjusting its gear shift program.



During the brief warm-up, transmission upshifting is delayed. This allows the catalytic converter to heat up more quickly to operating temperature.

The automatic transmission selects individual gears automatically, depending on:

- the gear selector lever position **D** with gear ranges (▷ page 166)
  - the selected shift program (**C/S**) (▷ page 170)
- or
- **(C/S/M)** (S 55 AMG only) (▷ page 171)
  - the position of the accelerator pedal (▷ page 170)
  - the vehicle speed

The current gear selector lever position and shift program (C/S) or (C/S/M) appear in the tachometer display (▷ page 22).

#### Warning!



It is dangerous to shift the gear selector lever out of **P** or **N** if the engine speed is higher than idle speed. If your foot is not firmly on the brake pedal, the vehicle could accelerate quickly forward or reverse. You could lose control of the vehicle and hit someone or something. Only shift into gear when the engine is idling normally and when your right foot is firmly on the brake pedal.

When the gear selector lever is in position **D**, you can influence transmission shifting by:

- limiting the gear range
- changing gears manually

### One-touch gearshifting

Even with an automatic transmission you can change the gears manually when the gear selector lever is in position **D**.

### Downshifting

- ▶ Briefly press the gear selector lever to the left in the **D-** direction.

The transmission will shift from the current gear to the next lower gear. This action simultaneously limits the gear range of the transmission (▷ page 166).

### Warning!



On slippery road surfaces, never downshift in order to obtain braking action. This could result in drive wheel slip and reduced vehicle control. Your vehicle's ABS will not prevent this type of loss of control.



To avoid overrevving the engine when the gear selector lever is moved to the **D-** direction, the transmission will not shift to a lower gear if the engine's max. speed would be exceeded.

### Upshifting

- ▶ Briefly press the gear selector lever to the right in the **D+** direction.

The transmission will shift from the current gear to the next higher gear as permitted by the shift program. This action simultaneously extends the gear range of the transmission.

## Controls in detail

### Automatic transmission

#### Canceling gear range limit

- ▶ Press and hold the gear selector lever in the **D+** direction until **D** reappears in the tachometer display field.

The transmission will shift from the current gear range directly to gear range **D**.

#### Shifting into optimal gear range

- ▶ Press and hold the gear selector lever in the **D-** direction.

The transmission will automatically select the gear range suited for optimal acceleration and deceleration. This will involve shifting down one or more gears.

## Controls in detail

### Automatic transmission

#### Gear ranges

With the gear selector lever in position **D**, you can limit the transmission's gear range by pressing the gear selector lever to the left (**D-**), and reverse the gear range limit by pressing the gear selector lever to the right (**D+**).

The selected gear range will appear in the tachometer display. If you press on the accelerator when the engine has reached its rpm limit, the transmission will upshift beyond any gear range limit selected.

	Effect
<b>6</b>	The transmission shifts through sixth gear only (applies only to vehicles with 7-speed automatic transmission).
<b>5</b>	The transmission shifts through fifth gear only (applies only to vehicles with 7-speed automatic transmission).
<b>4</b>	The transmission shifts through fourth gear only.
<b>3</b>	The transmission shifts through third gear only.  With this selection you can use the braking effect of the engine.

	Effect
<b>2</b>	The transmission shifts through second gear only.  Allows the use of engine's braking power when driving <ul style="list-style-type: none"><li>• on steep downgrades</li><li>• in mountainous regions</li><li>• under extreme operating conditions</li></ul>
<b>1</b>	The transmission operates in first gear only.  For maximum use of engine's braking effect on very steep or lengthy downgrades.

### Gear selector lever position

	Effect
<b>P</b>	<b>Park position</b> Gear selector lever position when the vehicle is parked. Place gear selector lever in position <b>P</b> only when vehicle is stopped. The park position is not intended to serve as a brake when the vehicle is parked. Rather, the driver should always set the parking brake in addition to placing the gear selector lever in position <b>P</b> to secure the vehicle.

	Effect
	The SmartKey can only be removed from the starter switch with the gear selector lever in position <b>P</b> . With the SmartKey removed the gear selector lever is locked in position <b>P</b> .
<b>R</b>	<b>Reverse gear</b> Place gear selector lever in position <b>R</b> only when vehicle is stopped.

## Controls in detail

### Automatic transmission

	Effect
<b>N</b>	<b>Neutral</b> No power is transmitted from the engine to the drive axle. When the brakes are released, the vehicle can be moved freely (pushed or towed).  To avoid damage to the transmission, never engage <b>N</b> while driving.  If the ESP is deactivated or malfunctioning: Move gear selector lever to <b>N</b> only if the vehicle is in danger of skidding, e.g. on icy roads.
<b>D</b>	<b>Drive</b> The transmission shifts automatically. All forward gears are available.



## Controls in detail

### Automatic transmission



Coasting the vehicle, or driving for any other reason with gear selector lever in **N** can result in transmission damage that is not covered by the Mercedes-Benz Limited Warranty.

#### Warning!



Getting out of your vehicle with the gear selector lever not fully engaged in position **P** is dangerous. Also, position **P** alone is not intended to or capable of preventing your vehicle from moving, possibly hitting people or objects.

Always set the parking brake in addition to shifting to position **P** (▷ page 45).

When parked on an incline, turn the front wheels towards the road curb.

Do not park this vehicle in areas where combustible materials such as grass, hay or leaves can come into contact with the hot exhaust system, as these materials could be ignited and cause a vehicle fire.

#### Warning!



When leaving the vehicle, always remove the SmartKey from the starter switch, take the SmartKey with KEYLESS-GO\* with you and lock your vehicle. Do not leave children unattended in the vehicle, or with access to an unlocked vehicle. Children could move the gear selector lever from position **P**, which could result in an accident and/or serious personal injury.

### Steering wheel gearshift control (Speedshift) S 55 AMG

You can change the gears manually on the steering wheel or by using the gear selector lever (▷ page 165).

Allow engine to warm up under low load use. Do not place full load on the engine until the operating temperature has been reached. Shift into reverse gear only when the vehicle is stopped.



Avoid spinning of a drive wheel for an extended period when driving off on slippery road surfaces. This may cause serious damage to the drivetrain which is not covered by the Mercedes-Benz Limited Warranty.

The steering wheel gearshift buttons are located to the left and right of the steering wheel.

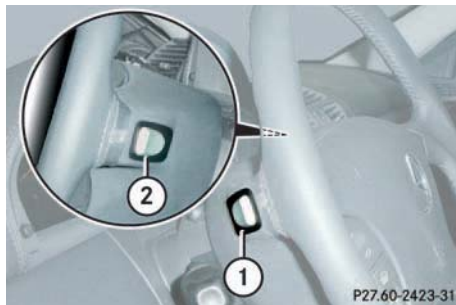

- ① Left button: downshift
- ② Right button: upshift

#### Downshifting

- ▶ Press button ① on the left side of the steering wheel.

The gear range is limited when you are not driving in the manual program mode (▷ page 166).

When driving in the manual program mode (▷ page 171), the transmission will shift from the current gear to the next lower gear (▷ page 172).

#### Warning!



On slippery road surfaces, never downshift in order to obtain braking action. This could result in drive wheel slip and reduced vehicle control. Your vehicle's ABS will not prevent this type of loss of control.



You cannot shift with the steering wheel gearshift buttons when the gear selector lever is in position **P**, **N** or **R**.

#### Upshifting

- ▶ Press button ② on the right side of the steering wheel.

The gear range is extended when you are not driving in the manual program mode (▷ page 166).

When driving in the manual program mode (▷ page 171), the transmission will shift from the current gear to the next higher gear (▷ page 172).



You cannot shift with the steering wheel gearshift buttons when the gear selector lever is in position **P**, **N** or **R**.

## Controls in detail

### Automatic transmission

#### Program mode selector switch

The program mode selector switch is located on the lower part of the center console.

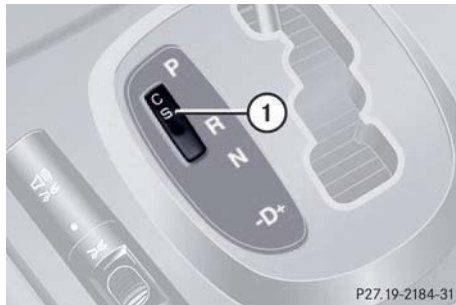

① Program mode selector switch

**S** Sport For standard driving

**C** Comfort For comfort driving



Never change the program mode when the gear selector lever is out of position **P**. This could result in a change of driving characteristics for which you may not be prepared.

- ▶ Press program mode selector switch ① repeatedly until the letter of the desired shift program appears in the tachometer display (▷ page 22).

Select **C** for comfort driving:

- The vehicle starts out in second gear (both forward and reverse) for gentler starts. This does not apply if full throttle is applied or gear range ① is selected.
- Traction and driving stability are improved on icy roads.
- Upshifts occur earlier even when you give more gas. The engine then operates at lower rpms and the wheels are less likely to spin.
- The power transmission ratio for gear selector lever position **R** changes depending on the program mode selected (**S** or **C**).

#### Accelerator position

Your driving style influences the transmission's shifting behavior:

Less throttle Earlier upshifting

More throttle Later upshifting

#### Kickdown

Use kickdown when you want maximum acceleration.

- ▶ Press the accelerator past the point of resistance.  
The transmission shifts into a lower gear.
- ▶ Ease on the accelerator when you have reached the desired speed.  
The transmission shifts up again.

#### Manual shift program S 55 AMG

In the manual shift program mode you can change the gears manually on the steering wheel (▷ page 168) or by using the gear selector lever (▷ page 165).

Allow engine to warm up under low load use. Do not place full load on the engine until the operating temperature has been reached. Shift into reverse gear only when the vehicle is stopped.



Avoid spinning of a drive wheel for an extended period when driving off on slippery road surfaces. This may cause serious damage to the drive train which is not covered by the Mercedes-Benz Limited Warranty.

#### Program mode selector switch

The program mode selector switch is located on the lower part of the center console.



① Program mode selector switch

**S** Sport For standard driving

**C** Comfort For comfort driving

**M** Manual For manual gear shifting

The selected shift program (C/S/M) is indicated in the tachometer display (▷ page 22).

#### Activating manual shift program

- ▶ Press program mode selector switch ① repeatedly until the M for manual shift program appears in the tachometer display.

The program mode switches to manual program mode **M**. Automatic shifting is switched off. The gear range is not limited.

You can change the gears manually when the gear selector lever is in position **D**. You can upshift or downshift through the gears in succession.

The current gear selector lever position and the selected shift program (C/S/M) is indicated in the tachometer display (▷ page 22).

## Controls in detail

### Automatic transmission

#### Downshifting

- ▶ Briefly press the gear selector lever to the left in the **D-** direction (▷ page 165).

or

- ▶ Press button ① on the left side of the steering wheel (▷ page 168).

The transmission shifts to the next lower gear.

#### Warning!



On slippery road surfaces, never downshift in order to obtain braking action. This could result in drive wheel slip and reduced vehicle control. Your vehicle's ABS will not prevent this type of loss of control.

#### Upshifting

- ▶ Briefly press the gear selector lever to the right in the **D+** direction (▷ page 165).

or

- ▶ Press button ② on the right side of the steering wheel (▷ page 168).

The transmission shifts to the next higher gear.

#### Kickdown

The kickdown can also be used for maximum acceleration when driving in the manual program mode.

- ▶ Press the accelerator past the point of resistance.

The transmission shifts to a lower gear.

- ▶ Shift up once the desired speed has been reached.



When driving at full throttle, the transmission shifts to the next higher gear when maximum engine speed has been reached.

When you brake or stop, the transmission shifts down to a gear from which you can easily accelerate or take off.

#### Deactivating manual shift program

- ▶ Press the program mode selector switch repeatedly until **S** or **C** for automatic shift program appears in the tachometer display.

or

- ▶ Restart the engine.

The transmission will go into the automatic shift program mode last selected (**S** or **C**).

Program mode **M** is not stored.



The last selected automatic program mode (**S** or **C**) is switched on when the engine is restarted in the automatic program mode.

#### Emergency operation (Limp home mode)

If vehicle acceleration worsens or the transmission no longer shifts, the transmission is most likely operating in limp home (emergency operation) mode. In this mode, only second gear and reverse gear can be activated.

- ▶ Stop the vehicle.
- ▶ Move gear selector lever to **P**.

- ▶ Turn off the engine.
- ▶ Wait at least ten seconds before re-starting.
- ▶ Restart the engine.
- ▶ Move gear selector lever to position **D** (for second gear) or **R**.
- ▶ Have the transmission checked at an authorized Mercedes-Benz Center as soon as possible.

## Controls in detail

### Good visibility

#### ▼ Good visibility

For information on the windshield wipers, see “Windshield wipers” (▷ page 48) and for setting the exterior rear view mirrors, see “Exterior rear view mirror” (▷ page 38).

### Rear view mirror

#### Automatic antiglare rear view mirror

The reflection brightness of the exterior rear view mirror on the driver’s side and the interior rear view mirror will respond automatically to glare when

- the ignition is switched on  
and
- incoming light from headlamps falls on the sensor in the interior rear view mirror

The interior rear view mirror will not react if

- reverse gear is engaged
- the interior lighting is turned on

#### Warning!



The automatic antiglare function does not react if incoming light is not aimed directly at sensors in the interior rear view mirror.

The interior rear view mirror and the exterior rear view mirror on the driver’s side do not react, for example, if the rear window sun shade\* is in raised position.

Glare can endanger you and others.

#### Warning!



In the case of an accident, liquid electrolyte may escape from the mirror housing if the mirror glass breaks.

Electrolyte has an irritating effect. Do not allow the liquid to come into contact with eyes, skin, clothing, or respiratory system. In case it does, immediately flush affected area with water, and seek medical help if necessary.

#### Warning!



Exercise care when using the passenger-side exterior rear view mirror. The mirror surface is convex (outwardly curved surface for a wider field of view). Objects in mirror are closer than they appear. Check your inside rear view mirror or glance over your shoulder before changing lanes.



Electrolyte drops coming into contact with the vehicle paint finish can be completely removed only while in the liquid state by applying plenty of water.

#### Activating exterior rear view mirror parking position

Follow these steps to activate the mirror parking position so that the passenger-side exterior rear view mirror will be turned downward to the stored position.

- ▶ Make sure you have stored a parking position for the passenger-side exterior rear view mirror (▷ page 122).
- ▶ Make sure the MIRROR SETTING WHEN PARKING function in the CONVENIENCE submenu of the control system is switched to ON (▷ page 162).
- ▶ Switch on ignition (if not already on).

- ▶ Press button ② for the passenger-side exterior rear view mirror.
- ▶ Place the gear selector lever in reverse gear **R**.

The passenger-side exterior rear view mirror will be turned downward to the stored position.



- ① Driver's side exterior rear view mirror button
- ② Passenger-side exterior rear view mirror button

The exterior rear view mirror returns to its previously stored driving position:

- ten seconds after you put the gear selector lever out of position **R**
- immediately once your vehicle exceeds a speed of approximately 6 mph (10 km/h)
- immediately when you press button ① for driver's side mirror.



## Controls in detail

### Good visibility

#### Electrically folding exterior rear view mirrors



Before driving the vehicle through an automatic car wash, fold the exterior mirrors in. Otherwise they may get damaged.

#### Folding the exterior mirrors in and out automatically

When the corresponding function in the control system is activated (▷ page 162):

- The exterior rear view mirrors automatically fold in as soon as the vehicle is locked from the outside.
- The exterior rear view mirrors automatically fold out as soon as the vehicle is unlocked and the driver's or front passenger door are subsequently opened.



If you are driving at more than approximately 9 mph (15 km/h), you will not be able to fold the exterior mirrors in.

#### Folding the exterior mirrors in and out manually

The exterior rear view mirrors can vibrate if they are not folded out completely.

The buttons are located on the driver's door.



- ① Folds the exterior mirrors out
- ② Folds the exterior mirrors in

- ▶ Switch on ignition.

#### Folding in

- ▶ Press button ② briefly.  
Both mirrors fold in.

#### Folding out

- ▶ Press button ① briefly.  
Both mirrors fold out.



If an exterior rear view mirror housing is forcibly pushed forward (hit from the rear), reposition it manually by applying firm pressure until it snaps back into place.

If an exterior rear view mirror housing is forcibly pushed rearward (hit from the front), press button ② to fold mirrors in, then press button ① to fold mirrors out. Do not force mirrors by hand as this may damage the adjustment mechanism.

## Windshield wipers

For more information on the windshield wipers, see “Windshield wipers” (▷ page 48).



Intermittent wiping is interrupted when the vehicle is at a standstill and a front door is opened.

A rain sensor automatically controls the windshield wipers depending on how wet the windshield is.

- ▶ Switch on ignition.
- ▶ Set wiper switch to position I (▷ page 48).

After the initial wipe, pauses between wipes are automatically controlled by the rain sensor.



Do not leave windshield wipers in intermittent setting when vehicle is taken to an automatic car wash or during windshield cleaning. Wipers will operate in the presence of water sprayed on the windshield, and wipers may be damaged as a result.

The switch should not be left in intermittent setting as the wipers will wipe the windshield once every time the engine is started. Dust that accumulates on the windshield might scratch the glass and/or damage the wiper blades when wiping occurs on a dry windshield.

## Controls in detail

### Good visibility

## Headlamp cleaning system\* (Standard on S 500, S 600, S 55 AMG)

The switch is located on the left side of the dashboard.



### ① Headlamp washer switch

- ▶ Switch on ignition.
- ▶ Press switch ①.

The headlamps are cleaned with a high-pressure water jet.

For information on filling up the washer reservoir, see “Windshield washer system and headlamp cleaning system\*” (▷ page 281).

## Controls in detail

### Good visibility

#### Sun visors

The sun visors protect you from sun glare while driving.

#### Warning!



Do not use the vanity mirror while driving. Keep the mirrors in the sun visors closed while vehicle is in motion. Reflected glare can endanger you and others.

- ▶ Swing sun visors down when you experience glare.

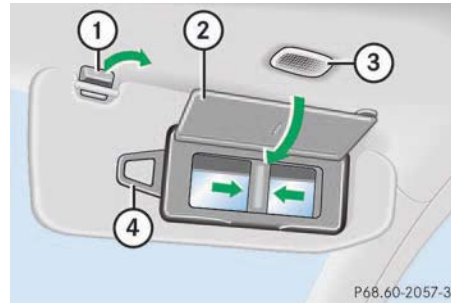

- ① Mounting
- ② Mirror cover
- ③ Mirror lamp
- ④ Document holder

- ▶ To use mirror, lift up cover ②. Mirror lamp ③ comes on.

If sunlight enters through a side window:

- ▶ Disengage sun visor from mounting ①.
- ▶ Pivot sun visor to the side.

Adjusting the vanity mirror:

- ▶ Slide mirror to the right or left.

Images in the mirror appear in normal size or larger, depending on the position of the mirror.

#### 1

If you disengage the sun visor from mounting ①, mirror lamp ③ will switch off.

#### Document holder

You can use the plastic tab of the document holder ④ to hold admission tickets, parking passes, or similar items in place.

## Controls in detail

### Good visibility

#### Rear window sunshade\*

The switch is located in the center console.



- ① Rear window sunshade switch
- ▶ Switch on ignition.
- ▶ Press switch ① briefly to raise the sunshade.
- ▶ Press switch ① briefly to lower the sunshade.

Always raise the sunshade fully for its support against the window frame.

#### Warning!



When operating the rear window sunshade, be sure that there is no danger of anyone being harmed by the raising or lowering procedure.

The raising or lowering procedure can be immediately reversed by pressing switch ①.

#### Warning!



When leaving the vehicle, always remove the SmartKey from starter switch, take the SmartKey with KEYLESS-GO\* with you, and lock your vehicle. Do not leave children unattended in the vehicle, or with access to an unlocked vehicle. Unsupervised use of vehicle equipment can cause an accident and/or serious personal injury.

#### Rear door window sunshade\*

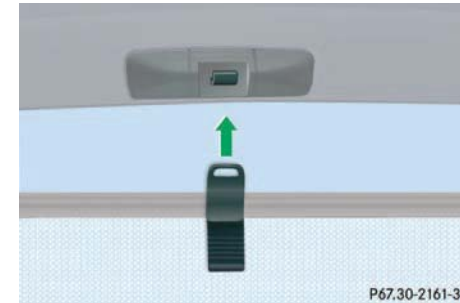

- ▶ To raise sunshade pull on the tab and engage in holder.
- ▶ To lower sunshade disengage tab and guide retraction.



Always guide the sunshade. Do not let it snap back abruptly, as the retractor could be damaged.

## Controls in detail

### Automatic climate control

#### ▼ Automatic climate control

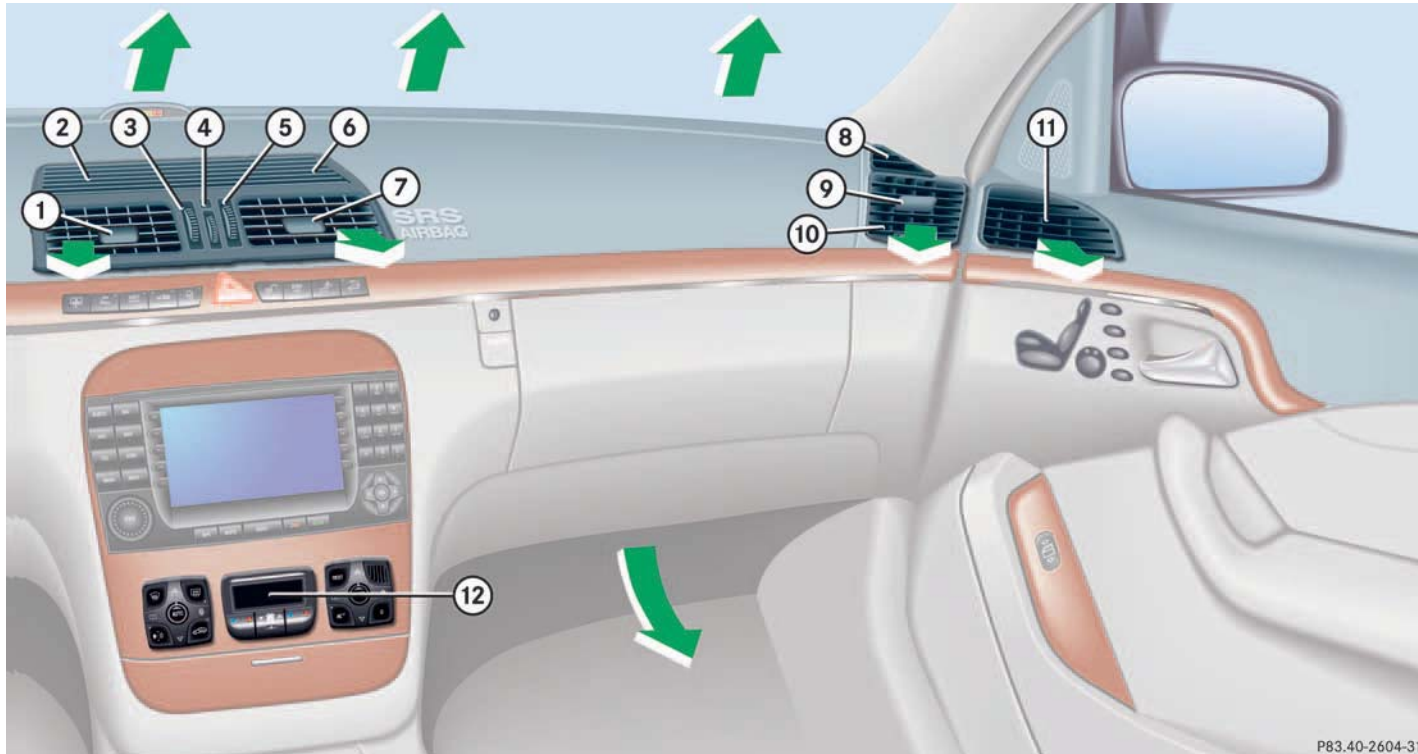

P83.40-2604-31

	Item
①	Left center air vent, adjustable
②	Left air vent, fixed
③	Thumbwheel for air volume control for left center air vent
④	Thumbwheel for air temperature control for center air vents
⑤	Thumbwheel for air volume control for right center air vent
⑥	Right air vent, fixed
⑦	Right center air vent, adjustable
⑧	Side defroster vent, fixed
⑨	Side air vent, adjustable
⑩	Thumbwheel for air volume control for side air vents
⑪	Door air vent
⑫	Automatic climate control panel

### Warning!



When operating the automatic climate control, the air that enters the passenger compartment through the air vents in the footwell can be very hot or very cold (depending on the set temperature). This may cause burns or frostbite on unprotected skin in the immediate area of the air vents. Always keep sufficient distance between unprotected parts of the body and the footwell air vents. If necessary change the air flow using the air distribution controls to direct the air away from the footwell air vents (▷ page 184).

## Controls in detail

### Automatic climate control



For draft-free ventilation, move the sliders for the center air vents ①, ⑦, ⑨ to the middle position.

## Controls in detail

### Automatic climate control



Automatic climate control panel

	Item
①	Windshield defroster
②	Rear window defroster
③	Display
④	Residual engine heat utilization (REST)
⑤	Automatic climate control on/off
⑥	Air distribution, right
⑦	AC cooling on/off (AC OFF)
⑧	Right side temperature control
⑨	Air volume (automatic, manual)
⑩	Left side temperature control
⑪	Air recirculation
⑫	Air distribution, left
⑬	Activated charcoal filter

The automatic climate control is operational whenever the engine is running. You can operate the climate control system in either the automatic or manual mode. The system cools or heats the interior depending on the selected interior temperature and the current outside temperature.

#### Warning!



When operating the automatic climate control, the air that enters the passenger compartment through the air vents in the footwell can be very hot or very cold (depending on the set temperature). This may cause burns or frostbite on unprotected skin in the immediate area of the air vents. Always keep sufficient distance between unprotected parts of the body and the footwell air vents. If necessary change the air flow using the air distribution controls to direct the air away from the footwell air vents (▷ page 184).

Nearly all dust particles, pollutants and odors are filtered out before outside air enters the passenger compartment through the air distribution system.

The air conditioning will not engage (no cooling) if the **AC<sup>OFF</sup>** mode is selected (▷ page 190).

### Warning!



Follow the recommended settings for heating and cooling given on the following pages. Otherwise the windows could fog up, impairing visibility and endangering you and others.



The current climate control settings (ON/OFF, temperature, air volume, activated charcoal filter, etc.) are stored for each SmartKey before it is removed from the starter switch or when the vehicle is locked using the SmartKey with KEYLESS-GO\* (▷ page 102).

If the vehicle interior is hot, ventilate the interior before driving off.

Keep the air intake grille in front of the windshield free of snow, leaves, sticks, and any other debris.

Do not obstruct air volume by placing objects on the air volume-through exhaust slots below the rear window.



When operating the climate control system in automatic mode, you will only rarely need to adjust the temperature, air volume and air distribution.

## Controls in detail

### Automatic climate control

#### Setting the temperature

Use temperature controls ⑩ and ⑧ (▷ page 182) to separately adjust the air temperature on each side of the passenger compartment. You should raise or lower the temperature setting in small increments, preferably starting at 72°F (22°C).

#### Increasing / decreasing

- ▶ Press button ⑩ or ⑧ repeatedly until the display shows the desired temperature.

The automatic climate control system will correspondingly adjust the interior air temperature.



## Controls in detail

### Automatic climate control

#### Adjusting the temperature for center air vents

When outside temperatures are low, you can manually raise the air temperature for the center and side air vents. The thumbwheel ④ is located between the center air vents (▷ page 180).

#### Automatic temperature control

- ▶ Turn thumbwheel ④ to **A**.  
The indicator lamp above the thumbwheel comes on. The temperature is automatically adjusted to the set value.

#### Turning on warm air





- ▶ Turn thumbwheel ④ in the direction of the white marking.  
Warm air will enter from the center air vent.

#### Turning on cooler air



- ▶ Turn thumbwheel ④ in the direction of the blue marking.  
Cooler air will enter from the center air vent.

#### Adjusting air distribution





Use air distribution controls ⑫ and ⑥ (▷ page 182) to separately adjust the air distribution on each side of the passenger compartment. The following symbols are found on the controls:

Symbol	Function
	Directs air through the center air vents
	Directs air to the windows
	Directs air into the entire vehicle interior
	Directs air to the footwells







### Adjusting manually

- ▶ Press left or right button **AUTO**.  
The button emerges and the ,  and  symbols become visible.
- ▶ Turn the marking on the regulator to the desired symbol.  
The air will be directed to the vents corresponding to this symbol.

### Adjusting automatically

- ▶ Press left or right button **AUTO** until it clicks in.  
The , ,  and  symbols are no longer visible.  
The air distribution is adjusted automatically.

### Windows fogged on the inside





- ▶ Press button **AC<sup>OFF</sup>** to switch on the air conditioning (▷ page 182).  
The indicator lamp in the button goes out.
- ▶ Press button  to switch off the air recirculation (▷ page 182).  
The indicator lamp on the button goes out.
- ▶ Make sure left and right button **AUTO** emerges.  
The , ,  and  symbols become visible.
- ▶ Press left and right  button.
- ▶ Set blower to the maximum speed.

## Controls in detail

### Automatic climate control

- ▶ Adjust left and right air vents ① and ⑥ upwards (▷ page 180).
- ▶ Increase temperature setting.
- ▶ Open side air vents ⑨ and direct them onto the side windows (▷ page 180).

### Windshield fogged on the outside

- ▶ Switch the windshield wipers on (▷ page 48).
- ▶ Press on both **AUTO** buttons until they click in.  
The , ,  and  symbols are no longer visible.

## Controls in detail

### Automatic climate control

#### Adjusting air volume

Use air volume control ⑨ (▷ page 182) for both automatic and manual air volume adjustment.

#### Adjusting automatically

- ▶ Press **A** on air volume switch ⑨ (▷ page 182).

The display shows “AUTO.” The air volume is adjusted automatically.

#### Adjusting manually

##### *Reducing air volume*

- ▶ Press switch ⑨ down until the desired air volume is reached.

The display shows the current level.

##### *Increasing air volume*

- ▶ Press switch ⑨ up until the desired air volume is reached.

The display shows the current level.

#### Maximum cooling MAXCOOL

If the left and right air distribution controls as well as the air volume control are set to **AUTO** and there is a high need for cooling, the display “AUTO MAXCOOL” appears.



This provides the fastest possible cooling of the vehicle interior (when windows and sliding/pop-up roof are closed).

## Defrosting



These settings should only be selected for a short time.

### Activating

- ▶ Press button  (▷ page 182).  
The indicator lamp on the button comes on.
- ▶ Switch off air recirculation, if selected.
- ▶ Press button  (▷ page 182).  
The indicator lamp on the button goes out.
- ▶ Close center air vents.
- ▶ Adjust side air vents upwards.

### Deactivating

- ▶ Press button  (▷ page 182).  
The indicator lamp on the button goes out. Defrosting is turned off.

## Air recirculation mode

Switch to air recirculation mode to prevent unpleasant odors from entering the vehicle from the outside. This setting cuts off the intake of outside air and recirculates the air in the passenger compartment.

### Warning!



When the outside temperature is below 41°F (5°C), only switch to air recirculation mode for short periods to prevent window fogging.

### Activating

- ▶ Press button  (▷ page 182).  
The indicator lamp on the button comes on.



If you keep button  pressed, the side windows and the sliding/pop-up roof will close.

## Controls in detail

### Automatic climate control

### Warning!



Never operate the side windows and the sliding pop/pop-up roof if there is the possibility of anyone being harmed by the closing procedure.

In the event that the procedure causes potential danger, the closing of the side windows can be immediately halted by pressing the respective window switch. The closing of the sliding/pop-up roof can be immediately halted by moving the sliding/pop-up roof switch in the overhead control panel in any direction.

The closing of the side windows and the sliding/pop-up roof can be reversed by again pressing and holding the  button.

## Controls in detail

### Automatic climate control



The air recirculation mode is activated automatically:

- at high outside temperatures
- if the concentration of carbon monoxide and nitrogen oxide in the outside air increases beyond a predetermined level, for example in a tunnel.

Please note that the charcoal filter must be activated (▷ page 188) for the air recirculation mode to be activated automatically.

If you have turned off the air conditioning (▷ page 190) or the outside temperature is below 41°F (5°C), the air recirculation mode will not switch on automatically.

#### Deactivating

- ▶ Press button  (▷ page 182).

The indicator lamp on the button goes out.



If you keep button  pressed, the side windows and the sliding/pop-up roof will return to their previous position.

The air recirculation mode is deactivated automatically:

- after five minutes if the outside temperature is below approximately 41°F (5°C)
- after five minutes if the air conditioning is turned off
- after 30 minutes if the outside temperature is above approximately 41°F (5°C)

At outside temperatures above 79°F (26°C) the system will not automatically switch back to outside air. A quantity of outside air is added after approximately 30 minutes.

### Charcoal filter

An activated charcoal filter markedly reduces bad odors and removes pollutants from air entering the passenger compartment.

#### Activating

- ▶ Press button  (▷ page 182).

The indicator lamp on the button comes on.



If you keep button  pressed, the side windows and the sliding/pop-up roof will close.

### Warning!



Never operate the side windows and the sliding /pop-up roof if there is the possibility of anyone being harmed by the closing procedure.

In the event that the procedure causes potential danger, the closing of the side windows can be immediately halted by pressing the respective window switch. The closing of the sliding/pop-up roof can be immediately halted by moving the sliding/pop-up roof switch in the overhead control panel in any direction.

The closing of the side windows and sliding/pop-up roof can be reversed by again pressing and holding the  button.

### Deactivating

- ▶ Press button  (▷ page 182).  
The indicator lamp on the button goes out.



If you keep button  pressed, the side windows and the sliding/pop-up roof will return to their previous position.

The system automatically switches to the air recirculation mode if the carbon monoxide (CO) or nitrogen oxide (NO<sub>x</sub>) concentration of the outside air increases beyond a predetermined level, for example in a tunnel.

The automatic air recirculation mode does not function if  is selected or if the outside temperature has fallen below 41°F (5°C).

The activated charcoal filter should be switched off when windows fog up on the inside, or if the passenger compartment needs to be quickly heated or cooled down.

## Controls in detail

### Automatic climate control

#### Rear window defroster

The rear window defroster uses a large amount of power. To keep battery drain to a minimum, switch off the defroster as soon as the rear window is clear. The defroster is automatically deactivated after approximately 6 to 17 minutes of operation depending on the outside temperature.

#### Activating

- ▶ Press button  (▷ page 182).  
The indicator lamp on the button comes on.

#### Deactivating

- ▶ Press button  (▷ page 182) again.  
The indicator lamp on the button goes out.

## Controls in detail

### Automatic climate control

#### Warning!



Any accumulation of snow and ice should be removed from the rear window before driving. Visibility could otherwise be impaired, endangering you and others.



If the rear window defroster switches off too soon and the indicator lamp starts flashing, this means that too many electrical consumers are operating simultaneously and there is insufficient voltage in the battery. The system responds automatically by deactivating the rear window defroster.

As soon as the battery has sufficient voltage, the rear window defroster automatically turns itself back on.

#### Deactivating the climate control system

##### Deactivating

It is possible to completely deactivate the automatic climate control system.

- ▶ Press button **0** (▷ page 182).  
The display shows “0”.

##### Reactivating

There are several ways to reactivate the automatic climate control system:

- ▶ Press one of the following buttons, **0**, , **AUTO**, a temperature control switch (▷ page 182) or air volume switch **9** on the automatic climate control panel.

#### Air conditioning

The air conditioning is operational while the engine is running and cools the interior air to the temperature set by the operator.



Condensation may drip out from underneath the vehicle. This is normal and not an indication of a malfunction.

##### Deactivating

It is possible to deactivate the air conditioning (cooling) function of the automatic climate control system. The air in the vehicle will then no longer be cooled or dehumidified.

- ▶ Press button **AC<sup>OFF</sup>** (▷ page 182).

The indicator lamp on the button **AC<sup>OFF</sup>** comes on.

### Activating

Moist air can fog up the windows. You can dehumidify the air with the air conditioning.

- ▶ Press **AC<sup>OFF</sup>** again (▷ page 182).

The indicator lamp on the **AC<sup>OFF</sup>** button goes out.

The air conditioning uses the refrigerant R134a. This refrigerant is free of CFCs which are harmful to the ozone layer.



If the **AC<sup>OFF</sup>** button on the automatic climate control panel starts to flash, this indicates that the air conditioning is losing refrigerant. The compressor has turned itself off. The air conditioning cannot be turned on again.

Have the air conditioning checked at the nearest authorized Mercedes-Benz Center.

### Residual heat and ventilation

With the engine switched off, it is possible to continue to heat or ventilate the interior for up to 30 minutes. This feature makes use of the residual heat produced by the engine.

#### Activating

- ▶ Turn the SmartKey in the starter switch to position **1** or **0**, or remove it from the starter switch.
- ▶ Press button **REST** (▷ page 182).

The indicator lamp on button **REST** comes on.

## Controls in detail

### Automatic climate control

#### Deactivating

- ▶ Press button **REST** (▷ page 182).

The indicator lamp on button **REST** goes out.

The residual heat is automatically turned off:

- when the ignition is switched on
- after about 30 minutes
- if the battery voltage drops



How long the system will provide heating depends on the coolant temperature and the temperature set by the operator. The blower will run at speed setting 1 regardless of the air distribution control setting.



## Controls in detail

### Automatic climate control

#### Ventilated storage compartment (except S 55 AMG)

The storage compartment under the front armrest (▷ page 233) can be ventilated when the automatic air conditioning is switched on. The switch is located inside the storage compartment in the front. The air temperature is about the same as that of the center air vents.

The air volume dependent on the setting of:

- Air distribution control
- Air volume control
- Air vents in the dashboard

The air temperature is about the same as that of the dashboard air vents. It cannot be regulated separately.

#### Switching ventilation on

- ▶ Open the storage compartment in front of the armrest, see “Storage compartment in front of armrest” (▷ page 232).
- ▶ Push upper portion of switch.

#### Switching ventilation off

- ▶ Open the storage compartment in front of the armrest, see “Storage compartment in front of armrest” (▷ page 232).
- ▶ Push lower portion of switch.



Do not obstruct the air vent in the storage compartment.



The compartment can get very warm due to its confined space. When storing heat sensitive objects in the compartment, close the air vent while heating the passenger compartment.

#### Rear passenger compartment adjustable air vents

##### Rear center console air vents

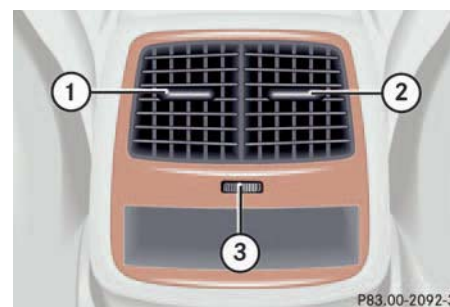

- ① Left center air vent, adjustable
- ② Right center air vent, adjustable
- ③ Thumbwheel for center air vents with adjustable booster blower

To open center air vents and to adjust the booster blower:

- ▶ Turn thumbwheel ③.



The booster blower allows air volume speed to the rear passenger compartment to be increased at four different levels.

The temperature at the air vents for rear passenger compartment ① and ② is the same as at the dashboard center air vents.

### Rear side air vents

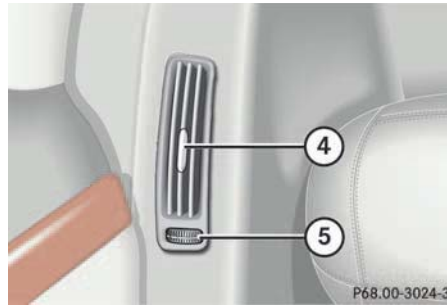

- ④ Rear side air vent, right and left
- ⑤ Air volume control for rear side air vent

To open rear side air vents:

- ▶ Turn thumbwheel ⑤ towards the window.

## Controls in detail

### Automatic climate control

#### Rear passenger compartment climate control\*

The automatic climate control is operational whenever the engine is running. You can operate the climate control system in either the automatic or manual mode. The system cools or heats the interior depending on the selected interior temperature and the current outside temperature.

The automatic climate control system is adjustable individually for the rear passenger compartment.

The control panel is located in the rear center console.

Nearly all dust particles, pollutants and odors are filtered out before outside air enters the passenger compartment through the air distribution system.

## Controls in detail

### Automatic climate control



When the rear seats are not occupied (rear seat belts unbuckled) the rear climate control system adopts the settings of the front climate control system.

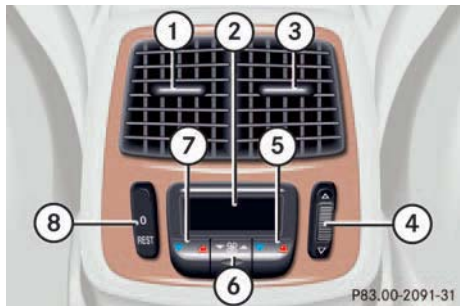

Rear automatic climate control panel

	Item
①	Left center air vent, adjustable
②	Display
③	Right center air vent, adjustable
④	Thumbwheel for air distribution
⑤	Temperature control, right
⑥	Air volume (automatic, manual)
⑦	Temperature control, left
⑧	Rear climate control system ON/OFF
	Residual engine heat utilization

### Warning!



Follow the recommended settings for heating and cooling as given in the instructions for the front automatic climate control (> page 180). Otherwise the windows could fog up, impairing visibility for the driver and endangering you and others.

#### ▼ Power windows

##### Opening and closing the windows

The side windows can be opened and closed electrically. The switches for all the side windows are on the driver's door. The switches for the respective windows are on the front passenger door and the rear doors.

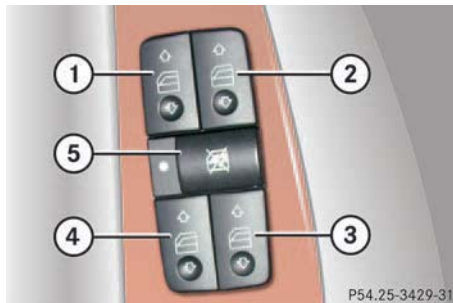

- ① Left front window
- ② Right front window
- ③ Right rear window
- ④ Left rear window
- ⑤ Rear window override switch (▷ page 74)

#### Warning!



When closing the windows, make sure that there is no danger of anyone being harmed by the closing procedure.

The closing of the door windows can be immediately halted by releasing the switch or, if the switch was pressed past the resistance point and released, by pressing the respective switch.

If the window encounters an obstruction that blocks its path in a circumstance where you pressed the switch past the resistance point and released it to close the window, the automatic reversal function will stop the window and open it slightly.



If the window encounters an obstruction that blocks its path in a circumstance where you are closing the window by pressing and holding the switch, by pressing and holding button  on the SmartKey, or by pressing and holding the lock button (vehicles with KEYLESS-GO\*) on the door handle,

the automatic reversal function will not operate.

When leaving the vehicle, always remove the SmartKey from starter switch, take the SmartKey with KEYLESS-GO\* with you, and lock your vehicle. Do not leave children unattended in the vehicle, or with access to an unlocked vehicle. Unsupervised use of vehicle equipment may cause an accident and/or serious personal injury.



You can also open or close the windows using the:

- SmartKey (summer opening/convenience feature) (▷ page 197)
- button  in the control panel of the automatic climate control (▷ page 182)
- button  in the control panel of the automatic climate control (▷ page 182)

## Controls in detail

### Power windows

- ▶ Switch on ignition.



You can still operate the windows when the SmartKey is in starter switch position **0** or has been removed:

- until the driver's or front passenger's door is opened
- for no more than five minutes

#### Opening the windows

- ▶ Press switch ① to ④ at the symbol to the resistance point.

The corresponding window will move downwards until you release the switch.

#### Closing the windows

- ▶ Press switch ① to ④ at the symbol to the resistance point.  
The corresponding window will move upwards until you release the switch.

#### Warning



If you press and hold the switch up when closing the window, and upward movement of the window is blocked by some obstruction including but not limited to arms, hands, fingers, etc., the automatic reversal will not operate.

#### Fully opening the windows (Express-open)

- ▶ Press switch ① to ④ at the symbol past the resistance point and release.

The corresponding window opens completely.

#### Fully closing the windows (Express-close)

- ▶ Press switch ① to ④ at the symbol past the resistance point and release.

The corresponding window closes completely.



If the upward movement of the window is blocked during the closing procedure, the window will stop and open slightly.

Remove the obstruction, press the switch again past the resistance point and release.

If the window still does not close when there is no obstruction, then hold the switch down. The side window will then close without the obstruction sensor function.

### Warning!



Driver's door only:  
If within five seconds you again press the switch past the resistance point and release, the automatic reversal will not function.

### Stopping windows

- ▶ Press respective switch again.



### Opening and closing the windows with the SmartKey

The sliding/pop-up roof (▷ page 199) will also be opened or closed when you operate the power windows with the SmartKey.

### Warning!



Never operate the windows or sliding/pop-up roof if there is the possibility of anyone being harmed by the opening or closing procedure.

In the event that the procedure causes potential danger, the procedure can be immediately halted by releasing the remote control button. To reverse direction of movement press  for opening or  for closing.

- ▶ Aim transmitter eye at the driver's door handle.

## Controls in detail

### Power windows

#### Opening (Summer opening feature)

If the weather is warm, you can ventilate the vehicle before driving off by simultaneously:

- opening the sliding/pop-up roof
- opening the side windows
- turning on the seat ventilation\* for the driver's seat

To do so, follow the instructions below:

- ▶ Press and hold button  after unlocking the vehicle.

The windows and sliding / pop-up roof begin to open after approximately one second.

- ▶ Release the  button to stop procedure.

## Controls in detail

### Power windows

#### *Closing (Convenience feature)*

- ▶ Press and hold button  after locking the vehicle.

The windows and sliding/pop-up roof begin to close after approximately one second.

- ▶ Release the  button to stop procedure.

Make sure all side windows and the sliding/pop-up roof are properly closed before leaving the vehicle.

#### **Closing the windows with the SmartKey with KEYLESS-GO\* (Convenience feature)**

The sliding/pop-up roof (▷ page 199) will also be closed when the power windows are operated with KEYLESS-GO.

- ▶ Press and hold lock button at door (▷ page 55) until the side windows and the sliding/pop-up roof are closed.

#### **Warning!**



When closing the windows and the sliding/pop-up roof, make sure that there is no danger of anyone being harmed by the closing procedure.

The windows will not automatically reopen if blocked during convenience closing.

If potential danger exists, proceed as follows:

- Release the lock button.
- Pull on the door handle and hold firmly. The side windows and the sliding/pop-up roof will open for as long as the door handle is held but the door is not opened.

#### **Synchronizing the power windows**

The power window must be resynchronized each time

- after the battery has been disconnected.
- if the power windows cannot be fully opened (Express-open) or closed (Express-close).

#### **Synchronizing**

- ▶ Switch on ignition.
- ▶ Press the power window switches at the symbol  until the side windows are closed.

Hold the switches for approximately one second.

The power windows are synchronized.

## ▼ Sliding/pop-up roof

### Opening and closing the sliding/pop-up roof

The sliding/pop-up roof can be opened and closed electrically. The switch for the sliding/pop-up roof is on the overhead control panel.



- ① Push up to raise roof at rear
- ② Pull down to lower roof at rear
- ③ Push forward to slide roof closed
- ④ Push back to slide roof open

With the roof closed or tilted open, a screen can be slid into the roof opening to guard against sun rays. When sliding the roof open, the screen will also retract.



## Controls in detail

### Sliding/pop-up roof

#### Warning!



When closing the sliding/pop-up roof, make sure that there is no danger of anyone being harmed by the closing procedure.

The closing procedure of the sliding/pop-up roof can be immediately halted by releasing the switch or, if the switch was moved past the resistance point and released, by moving the switch in any direction.

When leaving the vehicle, always remove the SmartKey from starter switch, take the SmartKey with KEYLESS-GO\* with you, and lock your vehicle. Do not leave children unattended in the vehicle, or with access to an unlocked vehicle. Unsupervised use of vehicle equipment can cause an accident and/or serious personal injury.



## Controls in detail

### Sliding/pop-up roof





To avoid damaging the seals, do not transport any objects with sharp edges which can stick out of the sliding/pop-up roof.

Do not open the sliding/pop-up roof if there is snow or ice on the roof, as this could result in malfunctions.

The sliding/pop-up roof can be opened or closed manually should an electrical malfunction occur (▷ page 352).



You can also open or close the sliding/pop-up roof using the:

- SmartKey (summer opening/convenience future) (▷ page 201)
- button  in the control panel of the automatic climate control (▷ page 182)
- button  in the control panel of the automatic climate control (▷ page 188)

- ▶ Switch on ignition.

#### Opening and closing the sliding/pop-up roof

- ▶ To open, close, raise or lower the sliding/pop-up roof, move the switch to the resistance point in the required direction ① to ④.

Release the switch when the roof has reached the desired position.

#### Express-opening and Express-closing the sliding/pop-up roof

- ▶ To open, close, raise or lower the sliding/pop-up roof, move the switch past the resistance point in the required direction ① to ④ and release. The sliding/pop up roof opens or closes completely, or opens to the last set opening position.



Selecting a sliding/pop-up roof opening position

To select a sliding/pop-up roof opening position, press the switch to the resistance point and release it when the sliding/pop-up roof has reached the desired position.

The sliding/pop-up roof now opens to the position set when the switch is pressed past the resistance point in the “open” direction.

#### Stopping the sliding/pop-up roof

- ▶ Move the switch in any direction.



If the movement of the sliding/pop-up roof is blocked during the closing procedure, the roof will stop and reopen slightly.



### Opening and closing the sliding/pop-up roof with the SmartKey

The power windows (▷ page 195) will also be opened or closed when you operate the sliding/pop-up roof with the SmartKey.

#### Warning!



Never operate the windows or sliding/pop-up roof if there is the possibility of anyone being harmed by the opening or closing procedure.

In the event that the procedure causes potential danger, the procedure can be immediately halted by releasing the remote control button. To reverse direction of movement, press  for opening or  for closing.

- ▶ Aim transmitter eye at the driver's door handle.

### Opening (Summer opening feature)

If the weather is warm, you can ventilate the vehicle before driving off by simultaneously:

- opening the sliding/pop-up roof
- opening the side windows
- turning on the seat ventilation\* for the driver's seat

To do so, follow the instructions below:

- ▶ Press and hold button  after unlocking the vehicle.

The windows and sliding/pop-up roof begin to open after approximately one second.

- ▶ Release the  button to stop procedure.

## Controls in detail

### Sliding/pop-up roof

#### Closing (Convenience feature)

- ▶ Press and hold button  after locking the vehicle.

The windows and sliding/pop-up roof begin to close after approximately one second.

- ▶ Release the  button to stop procedure.

Make sure all the side windows and the sliding/pop-up roof are properly closed before leaving the vehicle.

## Controls in detail

### Sliding/pop-up roof

#### Closing the sliding/pop-up roof with KEYLESS-GO\* (Convenience feature)

The power window (▷ page 195) will also be closed when the sliding/pop-up roof is operated with KEYLESS-GO.

- ▶ Press and hold lock button at door (▷ page 55) until the sliding/pop-up roof and the side windows are closed.

#### Warning!



When closing the windows and the sliding/pop-up roof, make sure that there is no danger of anyone being harmed by the closing procedure.

The sliding/pop-up roof will not automatically reopen if blocked during convenience closing.

If potential danger exists, proceed as follows:

- Release the lock button.
- Pull on the door handle and hold firmly. The side windows and the sliding/pop-up roof will open for as long as the door handle is held but the door is not opened.

#### Synchronizing the sliding/pop-up roof

The power sliding/pop-up roof must be re-synchronized each time after:

- the battery has been disconnected
- the sliding/pop-up roof has been closed manually
- the sliding/pop-up roof does not open smoothly
- a malfunction

#### Synchronizing

- ▶ Switch on ignition.
- ▶ Press and hold the switch in direction ① until the sliding/pop-up roof is fully raised at the rear.

Hold the switch for approximately one second.

The sliding/pop-up roof is synchronized.

## ▼ Driving systems

The driving systems of your vehicle are described on the following pages:

- Cruise control and DISTRONIC\*, with which the vehicle can maintain a preset speed
- AIRMATIC adjusts the vehicle suspension characteristics automatically and controls the vehicle level.
- ABC\* with vehicle level control systems, with which you can change vehicle suspension characteristics
- Parktronic\*, which serves as a parking assistant

For information on the BAS, ABS, and ESP driving systems, see “Driving safety systems” (▷ page 77).

### Cruise control

Cruise control automatically maintains the speed you set for your vehicle.

Use of cruise control is recommended for driving at a constant speed for extended periods of time. You can set or resume cruise control at any speed above 20 mph (30 km/h).

The cruise control function is operated by means of the cruise control lever.

The cruise control lever is the uppermost lever found on the left-hand side of the steering column (▷ page 20).

## Controls in detail

### Driving systems

#### Warning!



Cruise control is a convenience system designed to assist the driver during vehicle operation. The driver is and must remain at all times responsible for the vehicle speed and for safe brake operation.

Only use cruise control if the traffic, road and weather conditions make it advisable to travel at a steady speed.

- The use of cruise control can be dangerous on winding roads or in heavy traffic because conditions do not allow safe driving at a steady speed.
- The use of cruise control can be dangerous on slippery roads. Rapid changes in tire traction can result in wheel spin and loss of control.
- Deactivate cruise control when driving in fog.

The “Resume” function should only be operated if the driver is fully aware of the previously set speed and wishes to resume this particular preset speed.

## Controls in detail

### Driving systems



- ① Set current or higher speed
- ② Set current or lower speed
- ③ Cancel cruise control
- ④ Resume at last set speed

#### Setting current speed

- ▶ Accelerate or decelerate to the desired speed.
- ▶ Briefly lift ① or depress ② the cruise control lever.

The current speed is set.

- ▶ Remove your foot from the accelerator pedal.

Cruise control is activated.



On uphill or downhill grades, cruise control may not be able to maintain the set speed. Once the grade eases, the set speed will be resumed.

#### Canceling cruise control

There are several ways to cancel cruise control:

- ▶ Step on the brake pedal.

or

- ▶ Briefly push the cruise control lever to position ③.

Cruise control will be canceled. The last speed set will be stored for later use.



Moving gear selector lever to position **N** while driving also cancels cruise control. However, the gear selector lever should not be moved to position **N** while driving except to coast when the vehicle is in danger of skidding (e.g. on icy roads).



The last stored speed is canceled when you turn off the engine.

#### Setting a higher speed

- ▶ Lift the cruise control lever to position ① and hold it up until the desired speed is reached.
- ▶ Release the cruise control lever.  
The new speed is set.



Depressing the accelerator pedal does not deactivate cruise control. After brief acceleration (e.g. for passing), cruise control will resume the last speed set.

#### Setting a lower speed

- ▶ Depress the cruise control lever to position ② and hold it down until the desired speed is reached.
- ▶ Release the cruise control lever.  
The new speed is set.



When you use the cruise control lever to decelerate, the transmission will automatically downshift if the engine's braking power does not slow the vehicle sufficiently.

#### Fine adjustment in 1 mph (Canada: 1 km/h) increments

##### *Faster*

- ▶ Briefly tip the cruise control lever in the direction of arrow ①.

##### *Slower*

- ▶ Briefly tip the cruise control lever in the direction of arrow ②.

#### Setting to last stored speed ("Resume" function)

##### **Warning!**



The speed stored in memory should only be set again if prevailing road conditions permit. Possible acceleration or deceleration differences arising from returning to preset speed could cause an accident and/or serious injury to you and others.

- ▶ Briefly push the cruise control lever to position ④.  
The cruise control will resume the last set speed.
- ▶ Remove your foot from the accelerator pedal.

## Controls in detail

### Driving systems

#### Distronic\*

When activated, the Distronic adaptive cruise control system increases driving convenience afforded by the cruise control during travel on expressways and other major roads.

- If the Distronic distance sensor detects a slower moving vehicle directly ahead, your vehicle speed will be reduced so that you follow that vehicle at a preset distance.
- If there is no vehicle directly ahead of you, Distronic will function in the same way as cruise control (> page 203).

#### Warning!



Distronic adaptive cruise control is no substitute for active driving involvement. It does not react to stationary objects, nor recognize or predict the curvature and lane layout or the movement of vehicles ahead. Distronic can only apply a maximum of 20% of the vehicle's braking power.

It is the driver's responsibility at all times to be attentive to traffic and road conditions and to provide the steering, braking and other driving inputs necessary to retain control of the vehicle.

#### Warning!



Distronic is a convenience system. Its speed adjustment reduction capability is intended to make cruise control more effective and usable when traffic speeds vary. However, it is not intended to, nor does it, replace the need for extreme care. The responsibility for the vehicle speed and the distance to the vehicle ahead, including most importantly brake operation to assure safe stopping distance, always rests with the driver.

Distronic cannot take street and traffic conditions into account.

#### Warning!



Distronic requires familiarity with its operational characteristics. We strongly recommend that you review the following information carefully before operating the system.

#### i

For operation in the USA only: This device complies with Part 15 of the FCC Rules. Operation is subject to the following two conditions:

- This device may not cause harmful interference, and
- this device must accept any interference received, including interference that may cause undesired operation.

Any unauthorized modification to this device could void the user's authority to operate the equipment.

**Warning!**

Distronic cannot take street and traffic conditions into account. Only use DISTRONIC if the weather, road, and traffic conditions make it advisable to travel at a steady speed.

**Warning!**

Use of DISTRONIC can be dangerous on slippery roads. Rapid changes in tire traction can result in wheel spin and loss of control.

DISTRONIC does not act upon adverse sight distance conditions. Do not use DISTRONIC during conditions of fog and heavy rain, snow or sleet.

**Warning!**

Close attention to road and traffic conditions is imperative at all times, regardless of whether or not DISTRONIC is activated.

Use of DISTRONIC can be dangerous on winding roads or in heavy traffic because conditions do not allow safe driving at a steady speed.

DISTRONIC will not react to stationary objects in the roadway (e.g. a stopped vehicle in a traffic jam or a disabled vehicle). DISTRONIC will also not respond to oncoming vehicles.

Switch off DISTRONIC:

- when changing from the left to the right lane if vehicles are moving more slowly in the left lane
- when entering a turn lane or highway off ramp
- in complex driving situations, such as in highway construction zones

In these situations, DISTRONIC will continue to maintain the set speed unless deactivated.

**Controls in detail****Driving systems**

DISTRONIC is designed and intended only to maintain a set speed and keep a set distance from moving objects in front of it.

**Warning!**

The “Resume” function should only be operated if the driver is fully aware of the previously set speed and wishes to resume this particular preset speed.



## Controls in detail

### Driving systems

#### Distronic displays in the speedometer dial



#### Set speed

If DISTRONIC is activated, one or two segments come on around the set speed.



The vehicle speed displayed on the speedometer can briefly vary from the speed setting on the DISTRONIC system.



#### Segments

If DISTRONIC detects a vehicle directly ahead, the segments from the speed of the vehicle ahead to the set speed come on.

If DISTRONIC calculates that there is a danger of collision (▷ page 214):

- The red DISTRONIC warning lamp  in the instrument cluster comes on.
- An intermittent warning sounds.

- ▶ Immediately brake the vehicle to avoid a collision.

Under no circumstances should the driver await the intermittent warning sound before braking. See the following warning note.

The intermittent warning sound ceases and the red DISTRONIC warning lamp  goes out when the necessary distance to the vehicle ahead is again established.

#### Warning!



An intermittent warning sounds and the Distronic warning lamp  in the instrument cluster is illuminated if the Distronic system calculates that the distance to the vehicle ahead and your vehicle's current speed indicate that Distronic will not be capable of slowing the vehicle sufficiently to maintain the preset following distance, which creates a danger of a collision.

Immediately brake your vehicle to increase the distance between your vehicle and the vehicle in front of you. The warning sound is intended as a final caution that you have not interceded with your own braking inputs to avoid a potentially dangerous situation. Do not wait for the operation of the warning signal to intercede with your own braking, as that will result in potentially dangerous emergency braking which will not always result in an impact being avoided.

Tailgating increases the risk of an accident.

#### Warning!



Distronic brakes your vehicle with a maximum of  $6.5 \text{ ft/s}^2$  ( $2 \text{ m/s}^2$ ). This corresponds to about 20% of the maximum deceleration ability of your vehicle.



Distronic brakes the vehicle in an effort to restore the preset distance or to maintain the speed. The brake pedal is automatically applied as this happens which results in the brake pedal moving.

Keep driver's foot area clear at all times, including the area under the brake pedal. Objects stored in this area may impair pedal movement which could interfere with the braking ability of the Distronic system.

Do not place your foot under the brake pedal – your foot could become caught.

#### Distronic menu in the control system

In the Distronic menu you see the current settings for Distronic. What appears in the display depends on whether Distronic and the distance warning function are turned on or off.

- ▶ Press button  or  repeatedly until you see one of the following displays.

## Controls in detail

### Driving systems

#### Distronic deactivated

If Distronic is deactivated, the standard display of Distronic appears in the multifunction display.

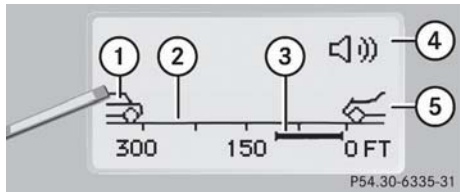

- ① Vehicle ahead, if detected
- ② Actual distance to vehicle ahead
- ③ Preset distance threshold to vehicle ahead
- ④ Symbol for activated distance warning function
- ⑤ Your vehicle

#### Distronic activated

When you turn Distronic on, you will see the set speed in the multifunction display for about five seconds. You then see the following display in the multifunction display.

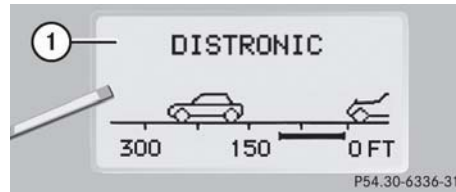

- ① Distronic activated

#### Cruise control lever

The Distronic system is operated by means of the cruise control lever.

The cruise control lever is the uppermost lever found on the left-hand side of the steering column.



- ① Set current or higher speed
- ② Set current or lower speed
- ③ Deactivate Distronic
- ④ Resume at last set speed

#### Activating Distronic

You can activate Distronic if:

- you are driving between 25 mph (40 km/h) and 110 mph (180 km/h)
- the ESP is activated (▷ page 79)

If Distronic has not been activated after pressing the cruise control lever you will see the message --- in the multifunction display.

In the following cases you cannot activate Distronic:

- up to two minutes after starting the engine
- when you brake
- if you have set the parking brake
- if the gear selector lever is in position **P**, **R**, or **N**
- if the ESP is switched off

#### Setting the current speed

- ▶ Accelerate or decelerate to the desired speed.
- ▶ Briefly lift or depress the cruise control lever.

Distronic is activated and the current speed is set.

- ▶ Remove your foot from the accelerator pedal.



If you do not take your foot off of the accelerator completely, the following message will appear in the multifunction display:

**DISTRONIC OVERRIDE.**

Distronic will not work to maintain the distance to a slower moving vehicles in front of you. Your vehicle speed will then be determined only by the accelerator pedal position.

#### Setting a higher speed

- ▶ Briefly tip the cruise control lever in the direction of arrow ① (▷ page 210) to increase vehicle speed in increments of 5 mph (Canada: 10 km/h)

The new speed is set.

The stored speed is displayed in the multifunction display for approximately five seconds (▷ page 210), and one or two segments around the stored speed come on on the speedometer (▷ page 208).



Depressing the accelerator pedal does not deactivate Distronic. After brief acceleration (e.g. for passing), the cruise control will resume the last speed set.

## Controls in detail

### Driving systems

#### Setting a lower speed

- ▶ Briefly tip the cruise control lever in the direction of arrow ② (▷ page 210) to decrease vehicle speed in increments of 5 mph (Canada: 10 km/h)

The new speed is set.

The stored speed is displayed in the multi-function display for approximately five seconds (▷ page 210), and one or two segments around the stored speed come on on the speedometer (▷ page 208).



When you use the cruise control lever to decelerate, the transmission will automatically downshift if the rate of deceleration is too low.

#### Fine adjustment in 1 mph (Canada: 1 km/h) increments

##### *Faster*

- ▶ Briefly tip the cruise control lever in the direction of arrow ④ (▷ page 210).

#### Setting to last stored speed (“Resume” function)

##### **Warning!**



The speed stored in memory should only be set again if prevailing road conditions permit. Possible acceleration or deceleration differences arising from returning to preset speed could cause an accident and/or serious injury you and others.

- ▶ Briefly tip the cruise control lever in the direction of arrow ④ (▷ page 210).  
Distronic is set to the last stored speed.
- ▶ Remove your foot from the accelerator pedal.

#### Deactivating Distronic

There are several ways to deactivate the Distronic system:

- ▶ Briefly tip the cruise control lever in the direction of arrow ③ (▷ page 210).

or

- ▶ Step on the brake pedal.

Distronic will be deactivated. The last speed set will be stored into memory.



The following message will appear in the multifunction display for approximately five seconds: **DISTRONIC OFF**.

The last stored speed is deleted when you turn off the engine.

Distronic deactivates automatically when:

- you set the parking brake
- you drive slower than 25 mph (40 km/h)
- the ESP is active (▷ page 79) or you deactivate the ESP
- you move the gear selector lever into position **N**

A signal will sound. The **DISTRONIC OFF** message appears in the multifunction display for approximately five seconds.

#### Warning!



Distronic switches off and releases the brakes when the vehicle decelerates below the minimum speed of approximately 25 mph (40 km/h) by operation of the system. At that time the driver must apply the brakes in order to reduce vehicle speed further or bring it to a stop.

#### Setting the following distance in Distronic

You can set the specified following distance for Distronic by varying the time setting between 1.0 and 2.0 seconds. Using this time setting and the current speed of your vehicle, Distronic calculates and sets the required following distance to the vehicle ahead. The set distance will be shown in the multifunction display field.

The thumbwheel for making the time setting is located on the lower section of the center console.

#### Warning!



It is up to the driver to exercise discretion to select the appropriate setting given road conditions, traffic, driver's preferred driving style and applicable laws and driving recommendations for safe following distance.

## Controls in detail

### Driving systems



- ① Distance warning function on/off switch
- ② Thumbwheel for setting distance

#### **Increasing distance**

Increasing the distance setting causes Distronic to maintain a greater following distance to the vehicle ahead.

- ▶ Turn thumbwheel ② towards .

#### **Decreasing distance**

Decreasing the distance setting causes Distronic to maintain a shorter following distance to the vehicle ahead.

- ▶ Turn thumbwheel ② towards .

#### **Distance warning function**

When Distronic is deactivated, this function will continue to warn you when recognizing a stationary obstacle or a slower vehicle moving in the vehicle's path and the danger of a collision exists:

- The distance warning lamp  in the instrument cluster comes on.
- An intermittent warning sounds.

If these warnings are issued, you must brake manually to maintain a safe distance and avoid a collision with the vehicle ahead.

When pressing the brake pedal, the warning sound stops. The warning sound also stops when the distance to the vehicle ahead is sufficient again without applying the brake pedal. In this case the distance warning lamp  also extinguishes.

#### Warning!



If the Distronic warning lamp  in the instrument cluster comes on while driving and/or an intermittent warning sounds, immediate attention on the part of the driver is required.

As required by the traffic situation, apply the brakes and navigate around a possible obstacle. However, do not drive by relying on the distance warning function, as this will result in an emergency braking application. Especially depending on road surface conditions and driver reaction, this will not always enable you to avoid a collision.



Complex driving situations are not always fully recognized by Distronic. This could result in wrong or missing distance warnings.

#### Activating

- ▶ Press switch ①.

The indicator lamp on the switch comes on. A loudspeaker symbol appears in the multifunction display (▷ page 210).

#### Deactivating

- ▶ Press switch ①.

The indicator lamp on the switch goes out.

#### Driving with Distronic

This section describes a number of driving situations where special precaution is required on the part of the driver. Be prepared to brake in such situations which will deactivate the Distronic system.

#### Warning!



Distronic works to maintain the speed selected by the driver unless a moving obstacle proceeding directly ahead of it in the same travel direction is detected (e.g. following another vehicle ahead of you at a distance set by Distronic). This means that:

- Your vehicle can pass another vehicle after you change lanes.
- While in a sharp turn or if the vehicle in front is in a sharp turn, Distronic could lose sight of a vehicle traveling in front of it, then your vehicle could accelerate to the previously selected speed. ▷▷



## Controls in detail

### Driving systems



Distronic regulates only the distance between your vehicle and those directly ahead of it, but does not register stationary objects in the road, e.g.:

- a stopped vehicle in a traffic jam
- a disabled vehicle
- an oncoming vehicle

The driver must always be on the alert, observe all traffic and intercede as required by steering or braking the vehicle.

#### Warning!



Distronic should not be used in snowy or icy road conditions.

The most likely cause for a malfunctioning system is a dirty sensor (located behind the hood grille), especially at times of snow and ice or heavy rain. In such a case, Distronic will switch off, and the message **CURRENTLY UNAVAILABLE SEE OPER. MANUAL** appears in the multifunction display.

For cleaning and care of the Distronic sensor, see “Cleaning the Distronic\* system sensor cover” (▷ page 299).



If the message **CURRENTLY UNAVAILABLE SEE OPER. MANUAL** disappears during driving and the last speed stored flashes for approximately five seconds, the dirt (e.g. slush) has dissolved; Distronic is again operational.

#### Turns and bends

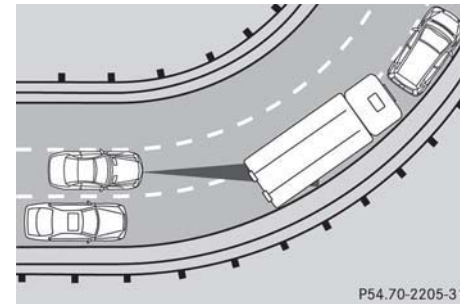

In turns or bends, Distronic may not detect a moving vehicle in front, or it may detect one too soon. This may cause your vehicle to brake late or unexpectedly.

*Offset driving*

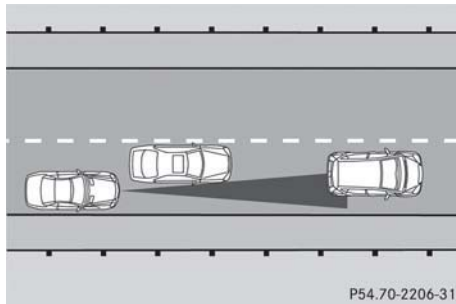

A vehicle traveling in your lane but offset from your direct line of travel may not be detected by Distronic. There will be insufficient distance to the vehicle ahead.

*Lane changing*

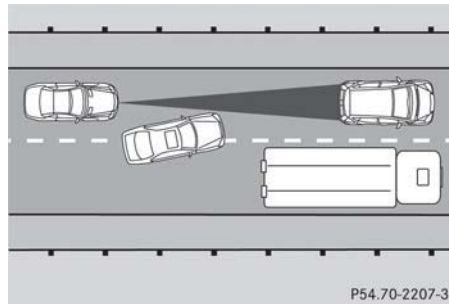

Distronic has not yet detected the vehicle changing lanes. There will be insufficient distance to the lane-changing vehicle.

*Narrow vehicles*

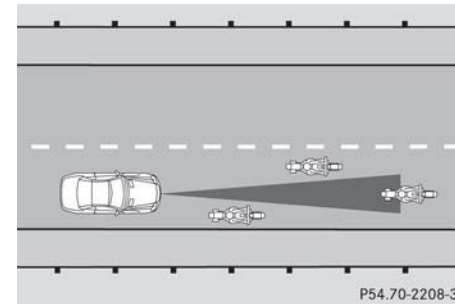

Because of their narrow profile, the vehicles traveling near the outer edge of the lane have not yet been detected by Distronic. There will be insufficient distance to the vehicles ahead.

## Controls in detail

### Driving systems

#### AIRMATIC

AIRMATIC automatically selects the optimum suspension tuning and ride height for your vehicle. AIRMATIC consists of two components:

- Adaptive Damping System (ADS)
- Level control system

The ADS automatically selects the optimum damping for the respective driving conditions. At the same time the suspension is set to either sporty or regular.

#### Suspension tuning

The suspension tuning is set according to:

- Your driving style
- Road surface conditions
- Your choice of suspension style, “sport” or “convenience”, which you select using the damping switch.

The following suspension styles are available:

- Convenience  
Both indicator lamps ① are off.
- Sports 1  
One indicator lamp ① is on.
- Sports 2  
Both indicator lamps ① are on.



① Indicator lamps

② Damping switch

- ▶ Start the engine.
- ▶ Press the damping switch ② until the desired suspension style is set.

#### i

The selected suspension style is stored in memory, even after the SmartKey is removed from the starter switch.

### Vehicle level control with AIRMATIC

Your vehicle automatically adjusts its ride height to:

- reduce fuel consumption
- increase vehicle safety

The vehicle chassis ride height is raised or lowered according to the selected level setting and to the vehicle speed:

- With increasing speed, ride height is reduced by up to approximately  $\frac{3}{4}$  in (20 mm).
- With decreasing speed, the ride height is again raised to the selected vehicle level.



These height adjustments are so small that you may not notice any change.

The following vehicle level settings can be selected when the vehicle is stationary:

Level	
<b>Normal</b>	For driving on normal roads. The indicator lamp is off.
<b>Raised</b>	For driving on rough roads or with snow chains. The indicator lamp is on.

Select the "Raised" level setting only when required by current driving conditions. Otherwise:

- Fuel consumption may increase
- Handling may be impaired

### Warning!



To help avoid personal injury, keep hands and feet away from wheel housing area, and stay away from under the vehicle when lowering the vehicle chassis.

## Controls in detail

### Driving systems

The switch with the indicator lamps is located in the upper part of the center console.



① Indicator lamp

② Vehicle level control switch

- ▶ Briefly press switch ② to change from one level setting to the other.

The message:

AIRMATIC  
VEHICLE RISING

appears in the multifunction display when changing from normal level to raised level.



## Controls in detail

### Driving systems

- ▷▷ The indicator lamp is then lit. The display switches off when the vehicle is raised.
- ▶ Press switch ② again to lower the vehicle. The indicator lamp is off.

The selected vehicle level setting remains stored in memory even if the engine is turned off and restarted except when you

- exceed a speed of 75 mph (120 km/h) or
- maintain a speed of between 50 mph (80 km/h) and 75 mph (120 km/h) for more than 5 minutes

The vehicle then lowers to regular level.

The message:

AIRMATIC  
LEV. SELECT. CANCELED!

appears in the multifunction display and the indicator lamp is off. The display switches off when the vehicle is raised.

### Active Body Control (ABC)\*

The ABC system automatically selects the optimum suspension tuning and ride height for your vehicle.

### Suspension tuning

The suspension tuning is set according to:

- Your driving style
- Road surface conditions
- The vehicle loading
- Your choice of suspension style, “sporty” or “regular”, which you select using the ABC button

The selected suspension style is stored in memory, even after the SmartKey is removed from the starter switch.

The ABC switch with the indicator lamps is located in the upper part of the center console.



- ① Indicator lamp
- ② ABC switch

- ▶ Start the engine.

### ***Suspension for sporty driving style***

The setting for sporty driving is selected when indicator lamp ① is illuminated.

- ▶ Press switch ②.

Indicator lamp ① comes on.

### ***Suspension for regular driving style***

The setting for regular driving is selected when indicator lamp ① is off.

- ▶ Press switch ②.

Indicator lamp ① goes out.

### **Vehicle level control with ABC\***

Your vehicle automatically adjusts its ride height to:

- reduce fuel consumption
- increase vehicle safety

The vehicle chassis ride height is raised or lowered according to the selected level setting and to the vehicle speed:

- With increasing speed, ride height is reduced by up to approximately 1.4 in (35 mm).
- With decreasing speed, the ride height is again raised to the selected vehicle level.

## **Controls in detail**

### **Driving systems**



These height adjustments are so small that you may not notice any change.

Select the level 1 and 2 settings only when required by current driving conditions.

Otherwise:

- Fuel consumption may increase
- Handling may be impaired

#### **Warning!**



To help avoid personal injury, keep hands and feet away from wheel housing area, and stay away from under the vehicle when lowering the vehicle chassis.

## Controls in detail

### Driving systems

The following vehicle level settings can be selected when the vehicle is stationary:

Vehicle level when stationary	Use for	Ride height increase over normal	Automatic lowering	Indicator lamps
Normal	Normal operation	None	Max. approx. 0.6 in (15 mm)	Both lamps off
Raised level 1	Driving with snow chains (▷ page 293)	Max. 0.4 in (10 mm) <sup>1</sup>	Max. approx. 1.0 in (25 mm)	One lamp lit
Raised level 2	Very rough road surface conditions	Max. 0.8 in (20 mm) <sup>1</sup>	Max. approx. 1.4 in (35 mm)	Both lamps lit

<sup>1</sup> Dependent on load

The switch with the indicator lamps is located in the upper part of the center console.



- ① Indicator lamps
- ② Vehicle level control switch

- ▶ Briefly press switch ② to change from one level setting to the next. When vehicle is at level 2, pressing the switch will return the vehicle to normal level.

The message:

ACTIVE BODY CONTROL  
VEHICLE RISING!

appears in the multifunction display. The display switches off when the vehicle is raised.



Pressing the switch twice in quick succession will cause the vehicle to immediately raise or lower according to the starting level.

The selected vehicle level setting remains stored in memory even if the engine is turned off and restarted.

#### ***Normal level (see table)***

Speed-dependent lowering of vehicle chassis (approximate values):

- Between 0 mph (0 km/h) and 40 mph (65 km/h) – none
- Between 40 mph (65 km/h) and 87 mph (140 km/h) – lowered progressively by approximately 0.6 in (15 mm).

#### ***Raised level 1 (see table)***

Speed-dependent lowering of vehicle chassis (approximate values):

- Between 0 mph (0 km/h) and 38 mph (60 km/h) – raised by approximately 0.4 in (10 mm)
- Between 38 mph (60 km/h) and 118 mph (190 km/h) – lowered progressively by approximately 1.0 in (25 mm)

#### ***Raised level 2 (see table)***

Speed-dependent lowering of vehicle chassis (approximate values):

- Between 0 mph (0 km/h) and 18 mph (30 km/h) – raised by approximately 0.8 in (20 mm)
- Between 18 mph (30 km/h) and 38 mph (60 km/h) – lowered progressively by approximately 0.4 in (10 mm)
- Between 38 mph (60 km/h) and 118 mph (190 km/h) – lowered progressively by additional approximately 1.0 in (25 mm)



## Controls in detail

### Driving systems

#### Parktronic\* (Parking assist)

##### Warning!



The Parktronic is a supplemental system. It is not intended to, nor does it replace, the need for extreme care. The responsibility during parking and other critical maneuvers always rests with the driver.

Special attention must be paid to objects with smooth surfaces or low silhouettes (e.g. trailer couplings, painted posts, or road curbs). Such objects may not be detected by the system and can damage the vehicle.

The operational function of the Parktronic system can be affected by dirty sensors, especially at times of snow and ice, see “Cleaning the Parktronic\* system sensors” (▷ page 299).

Interference caused by other ultrasonic signals (e.g. working jackhammers or the air brakes of trucks) can cause the system to send erratic indications, and should be taken into consideration.

##### Warning!



Make sure that no persons or animals are in the area in which you are maneuvering. You could otherwise injure them.

The Parktronic system is an electronic aid designed to assist the driver during parking maneuvers. It visually and audibly indicates the relative distance between the vehicle and an obstacle.

The Parktronic system is automatically activated when you switch on the ignition and release the parking brake. The Parktronic system deactivates at speeds over 11 mph (18 km/h). At lower speeds the Parktronic system turns on again.

The Parktronic system monitors the surroundings of your vehicle with six sensors in the front bumper and four sensors in the rear bumper.

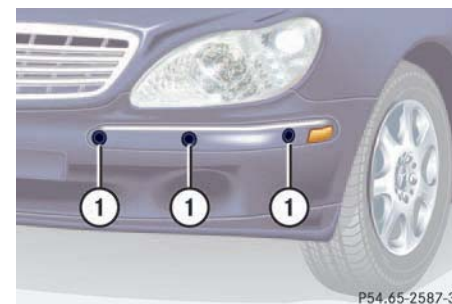

P54.65-2587-31

① Sensors in the front bumper

## Controls in detail

### Driving systems

#### Range of the sensors

To function properly, the sensors must be free of dirt, ice, snow and slush. Clean the sensors regularly, being careful not to scratch or damage the sensors.

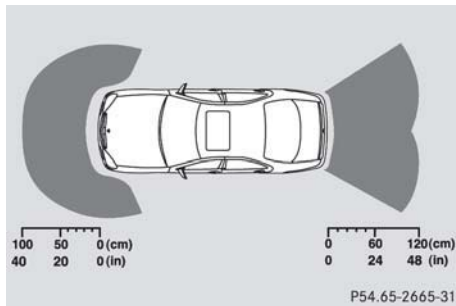
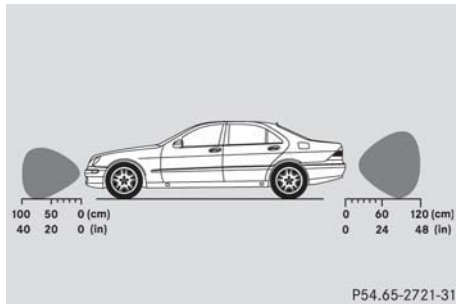

#### Front sensors

Center	<b>approx. 40 in (100 cm)</b>
Corners	<b>approx. 24 in (60 cm)</b>

#### Rear sensors

Center	<b>approx. 48 in (120 cm)</b>
Corners	<b>approx. 32 in (80 cm)</b>



During parking maneuvers, pay special attention to objects located above or below the height of the sensors (e.g. planters or trailer hitches). The Parktronic system will not detect such objects at close range and damage to your vehicle or the object may result.

Ultrasonic signals from outside sources (e.g. truck air brakes or jackhammers) may impair the operation of the Parktronic system.

#### Minimum distance

Center	<b>approx. 8 in (20 cm)</b>
Corners	<b>approx. 6 in (15 cm)</b>

If the system detects an obstacle in this range, all the warning lamps come on and you hear a warning signal. If the obstacle is closer than the minimum distance, the actual distance might no longer be indicated by the system.

## Controls in detail

### Driving systems

#### Warning indicators

Visual signals indicate to the driver the relative distance between the sensors and an obstacle. The warning indicators for the front area are located above the left air vents and center air vents in the dashboard (▷ page 21). The warning indicator for the rear area is integrated in the rear trim.

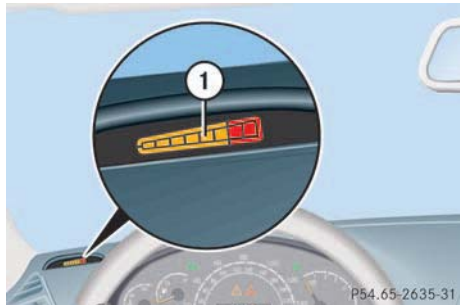

① Left front area warning indicator

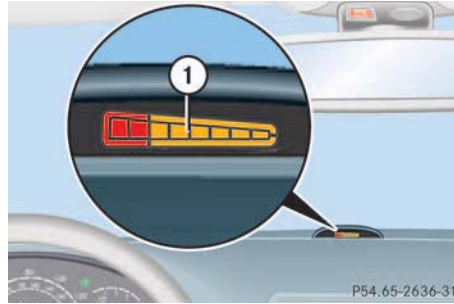

① Right front area warning indicator

Each warning indicator is divided into six yellow and two red segments for either side of the vehicle. The Parktronic system is ready when the border around the indicator is illuminated.

The position of the gear selector lever determines which warning indicators will be activated.

Selector lever position	Warning indicator
D	Front area activated
R or N	Front and rear area activated
P	Neither activated

As your vehicle approaches an object, one or more segments will come on, depending on the distance between your vehicle and the object. When the eighth segment comes on, you have reached the minimum distance.

- **Front area:** An intermittent acoustic warning will sound as the first red segment comes on and a constant acoustic warning, both lasting a maximum of three seconds, will sound for the eighth segment, i.e. the second red segment. The signal is canceled when the gear selector lever is placed in position **P**.
- **Rear area:** An intermittent acoustic warning will sound as the first red segment comes on and a constant acoustic warning, both lasting a maximum of three seconds, will sound for the eighth segment, i.e. the second red segment. The signal is canceled when the gear selector lever is placed in position **D** or **P**.

#### Switching the Parktronic system on/off

You can switch off the Parktronic system manually.

The Parktronic switch is located in the upper section of the center console.



- ① Indicator lamp
- ② Parktronic on/off

#### Switching off the Parktronic system

- ▶ Press switch ②.
- Indicator lamp ① comes on.

#### Switching on the Parktronic system

- ▶ Press switch ② again.
- Indicator lamp ① goes out.

## Controls in detail

### Driving systems

#### Parktronic malfunction

There is a malfunction in the Parktronic system if the red segments of the Parktronic warning indicator come on and a warning sounds. The Parktronic system will switch itself off after 30 seconds and the indicator lamp on the Parktronic switch comes on.

- ▶ Have the Parktronic system checked by an authorized Mercedes-Benz Center as soon as possible.

If only the red segments of the Parktronic warning indicator come on and no warning sounds, then the sensors of the Parktronic system are dirty or malfunctioning. Malfunction may also be caused by interference from other radio or ultrasonic signals. The Parktronic system will switch itself off after 20 seconds.

- ▶ Clean Parktronic system sensors (▷ page 299).
- ▶ Switch on ignition.

or

- ▶ Check Parktronic operation at another location to rule out interference from outside radio or ultrasonic signals.

▼ Loading

Roof rack\*

**Warning!**



Use only roof racks approved by Mercedes-Benz for your vehicle model to avoid damage to the vehicle. Follow manufacturer's installation instructions.



Preparing roof rack installation

- ▶ Open trim at the trim strips in the roof.
- ▶ Secure the roof rack according to manufacturer's instructions for installation.



Load the roof rack in such a way that the vehicle cannot be damaged while driving.

Make sure

- you can fully raise the sliding/pop-up roof
- you can fully open the trunk

Loading instructions

The total load weight including vehicle occupants and luggage/cargo should not exceed the vehicle capacity weight indicated on the corresponding label located on the driver's door pillar.

## Controls in detail

### Loading

#### Warning!



Always fasten items being carried as securely as possible.

In an accident, during hard braking or sudden maneuvers, loose items will be thrown around inside the vehicle and can cause injury to vehicle occupants unless the items are securely fastened in the vehicle.

To help avoid personal injury during a collision or sudden maneuver, exercise care when transporting cargo. Put luggage or cargo in the trunk if possible. Do not pile luggage or cargo higher than the seat backs. Do not place anything on the rear-window shelf.

Never drive vehicle with trunk open. Deadly carbon monoxide (CO) gases may enter vehicle interior resulting in unconsciousness and death.

#### Cargo tie-down hooks



Six hooks are located in the trunk.

- ▶ Carefully secure cargo by applying even load on all hooks with rope of sufficient strength to hold down the cargo.

## ▼ Useful features

### Storage compartments

#### Warning!



To help avoid personal injury during a collision or sudden maneuver, exercise care when stowing objects in the vehicle. Put luggage or cargo in the trunk if possible. Do not pile luggage or cargo higher than the seat backs.

Luggage nets cannot secure hard or heavy objects.

Keep compartment lids closed. This will help to prevent stored objects from being thrown about and injuring vehicle occupants during an accident.

### Glove box

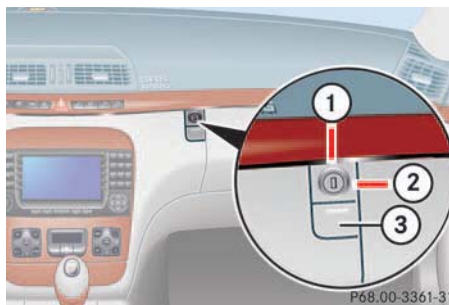

- ① Unlocked
- ② Locked
- ③ Glove box lid release

#### Locking the glove box

- ▶ Insert mechanical key (▷ page 348) into the glove box lock.
- ▶ Turn the mechanical key to position ②.

#### Unlocking the glove box

- ▶ Insert mechanical key (▷ page 348) into the glove box lock.
- ▶ Turn the mechanical key to position ①.

#### Opening the glove box

- ▶ Press glove box lid release ③.  
The glove box lid opens downward.

#### Closing the glove box

- ▶ Push lid up to close.

## Controls in detail

### Useful features



## Controls in detail

### Useful features

#### Storage compartment in the glove box

A storage compartment is located in the cover of the glove box. It can be used to store check cards, pens, a flashlight, etc.



① Storage compartment in glove box

- ▶ Lightly press the marking on the lid of storage compartment ①.

The lid opens upward.

#### Storage compartment in the center console

The storage compartment is located in the lower portion of the center console.



① Storage compartment

#### Opening

- ▶ Slide the mark on the compartment cover forward.

#### Closing

- ▶ Lightly press the mark on the compartment cover forward. The cover closes automatically.

#### Storage compartment in front of armrest

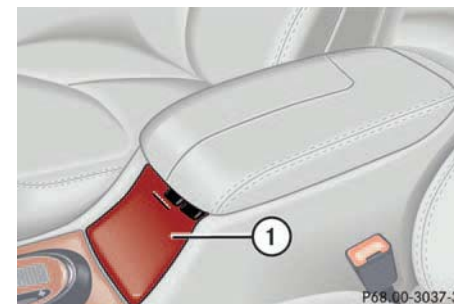

① Storage compartment

#### Opening

The compartment contains a cup holder (▷ page 236).

- ▶ Lightly touch cover plate ①.

The cover opens automatically.

#### Closing

- ▶ Lightly push cover plate ① up until it engages.

#### Storage compartment below the front armrest

The buttons are located under the cushion of the armrest.

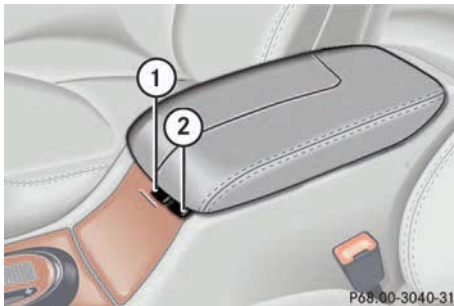

- ① Button to open storage compartment (except S 55 AMG)
- ② Button to open storage tray

#### Opening storage compartment (except S 55 AMG)

- ▶ Press button ① and lift the armrest lid.



The storage compartment can be heated or cooled.

The compartment can get very warm due to its confined space. When storing heat-sensitive objects in the compartment, close the air vent (▷ page 192) while heating the passenger compartment.



Do not obstruct the air vent in the storage compartment.

#### Opening storage tray

The tray contains a coin holder.

- ▶ Press button ② and lift the armrest.



Do not store any objects under the storage tray.

Do not let bank cards, credit cards, or other cards with a magnetic strip come near the storage tray, as a magnet built into the tray could erase or change the information on the card.

## Controls in detail

### Useful features

#### Compartment for glasses

The compartment for glasses is located under the armrest in the center console.

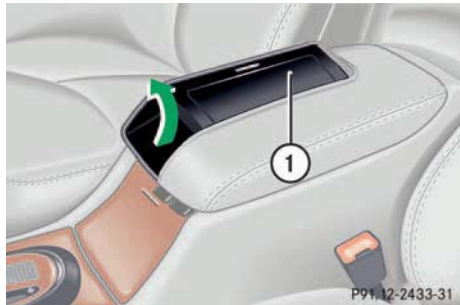

① Compartment for glasses

#### Opening compartment for glasses

- ▶ Fold the right side of the armrest upwards.

#### Telephone holder\*

The telephone holder is located under the armrest in the center console.



① Telephone holder

#### Opening telephone holder

- ▶ Fold the right side of the armrest upwards.

#### Storage compartments in the rear passenger compartment

##### Armrest with integrated storage compartment

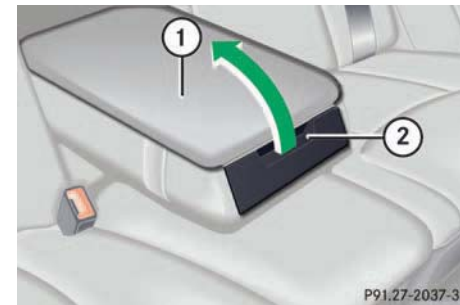

- ① Rear armrest
- ② Lid handle

Opening the storage compartment:

- ▶ Pull down the armrest by its strap.
- ▶ Press handle ② and lift lid.



Before storing the armrest in the backrest, close the storage compartment lid.

## Controls in detail

### Useful features

#### Storage compartment between rear seats\*

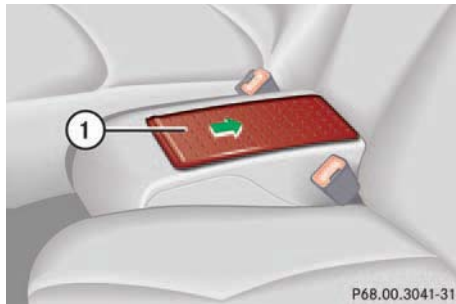

① Cover

#### Opening

- ▶ Slide cover ① rearward.

#### Closing

- ▶ Slide cover ① forward.

#### Storage compartment in rear shelf\*

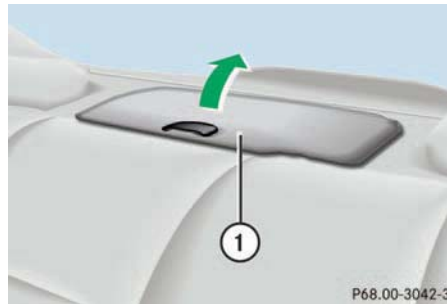

① Rear shelf compartment

#### Opening

- ▶ Lift the lid using the handle in the front.

#### Storage compartments under the front seats

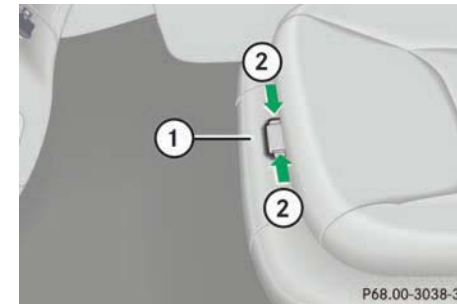

① Lid

② Buttons

#### Opening

- ▶ Press buttons ② together and fold lid ① down.

#### Closing

- ▶ Close lid ① until both buttons ② of lock engage.

## Controls in detail

### Useful features

#### Cup holder in front of seat armrest

##### Warning!



When not in use, keep the cup holder closed while traveling. Place only containers that fit into the cup holder to prevent spills. Use lids on open containers and do not fill containers to a height where the contents, especially hot liquids, could spill during vehicle maneuvers.



Only place containers with a maximum diameter of 2 3/4 in (72 mm) in the cup holder. Larger containers could damage the holder arm.

#### Folding out cup holder

The cup holder is located in the storage compartment in front of the armrest.



- ① Button for folding out the cup holder
- ▶ Open the storage compartment in front of armrest (▷ page 232).
- ▶ Push button ①.

The cup holder opens automatically.

#### Folding in cup holder



- ① Cup holder
- ▶ Swing cup holder ① back and press it into the storage compartment until it engages.

### Cup holder in rear seat armrest

#### Warning!



When not in use, keep the cup holder closed. Place only containers that fit into the cup holder to prevent spills. Use lids on open containers and do not fill containers to a height where the contents, especially hot liquids, could spill during vehicle maneuvers.

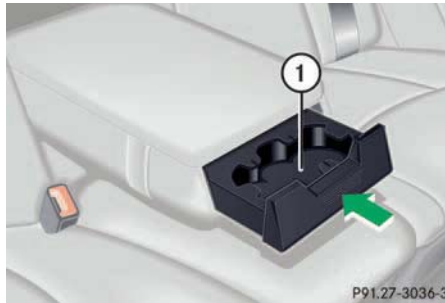

① Compartment for cup holder

#### Opening cup holder

- ▶ Push front of sliding compartment ①. The cup holder slides out.

#### Closing cup holder

- ▶ Push sliding compartment ① back until it engages.

## Controls in detail

### Useful features

### Parcel net in front passenger footwell

A small convenience parcel net is located in the front passenger footwell. It is for small and light items, such as road maps, mail, etc.

#### Warning!



Do not place heavy or fragile objects, or objects having sharp edges, in the parcel net.

In an accident, during hard braking, or sudden maneuvers they could be thrown around inside the vehicle and cause injury to vehicle occupants.

## Controls in detail

### Useful features

#### Parcel net in trunk

You can hang a parcel net in the trunk. The hooks and the parcel net in the trunk can hold a load of up to 29.8 lbs (13.5 kg).

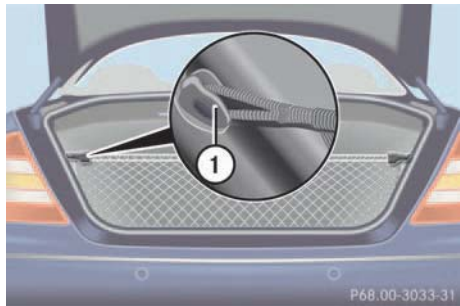

① Hook

- ▶ Hang the parcel net on hooks ① on the left and right sides of the trunk.



The parcel net cannot protect or sufficiently secure goods in the event of an accident.

#### Ashtrays

##### Center console ashtray

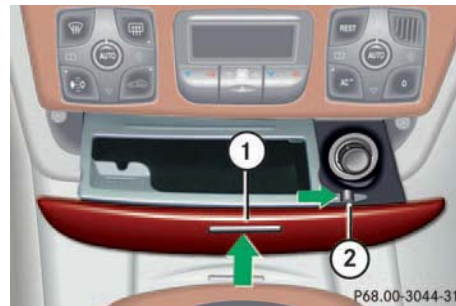

① Cover plate

② Button for disengaging ashtray

##### Opening ashtray

- ▶ Briefly touch cover plate ①.  
The ashtray opens automatically.

##### Removing ashtray insert

###### Warning!



Remove front ashtray only with vehicle standing still. Set the parking brake to secure vehicle from movement. Move gear selector lever to position **N**. With gear selector lever in position **N** turn off the engine.

- ▶ Secure vehicle from movement by setting the parking brake. Move the gear selector lever to position **N**.

Now you have more room to take out the insert.

- ▶ Push sliding button ② to the right.  
The ashtray is disengaged and slides out a short way.
- ▶ Remove insert from ashtray frame.

##### Reinstalling the ashtray insert

- ▶ Install insert by pushing it back into the frame until it engages.

## Controls in detail

### Useful features

#### Rear door ashtray

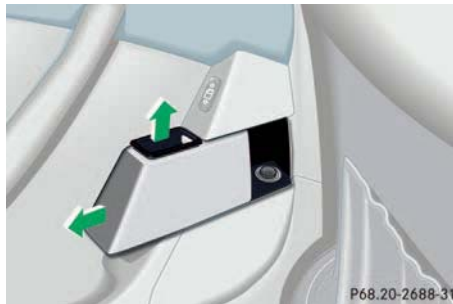

#### Opening ashtray

- ▶ Lightly touch the back of the ashtray.

#### Removing ashtray insert

- ▶ Pull the ashtray back slightly and remove the insert (see arrows).

#### Reinstalling the ashtray insert

- ▶ Position the insert and press down while sliding forward.

#### Cigarette lighters



#### ① Center console cigarette lighter

- ▶ Make sure the ignition is switched on.

All the lamps in the instrument cluster should come on.

- ▶ Push in cigarette lighter ①.

The lighter will pop out automatically when hot.

#### Warning!



Never touch the heating element or sides of the lighter; they are extremely hot. Hold the knob only.

When leaving the vehicle, always remove the SmartKey from the starter switch, take the SmartKey with KEYLESS-GO\* with you and lock your vehicle. Do not leave children unattended in the vehicle, or with access to an unlocked vehicle. Unsupervised use of vehicle equipment may cause an accident and/or serious personal injury.



The lighter socket can be used to accommodate electrical accessories up to a maximum 85 W.



## Controls in detail

### Useful features

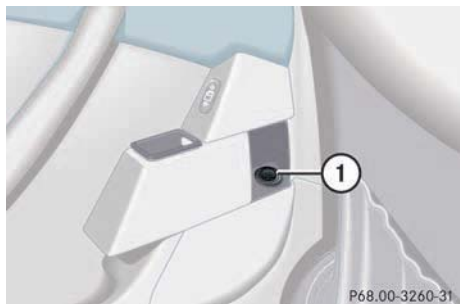

#### ① Rear door lighters

- ▶ Make sure the ignition is switched on.  
All the lamps in the instrument cluster should come on.
- ▶ Lightly touch the back of the ashtray to open it (▷ page 239).
- ▶ Push in cigarette lighter ①.  
The lighter will pop out automatically when hot.



Operation of the rear door lighters is only possible, if the override switch (▷ page 74) is deactivated.

### Warning!



Never touch the heating element or sides of the lighter; they are extremely hot. Hold the knob only.

To avoid possible injury to children sitting in the rear seat, deactivate the operation of the rear door windows, see (▷ page 74). Deactivation of the rear windows also deactivates the lighters.

When leaving the vehicle, always remove the SmartKey from the starter switch, take the SmartKey with KEYLESS-GO\* with you and lock your vehicle. Do not leave children unattended in the vehicle, or with access to an unlocked vehicle. Unsupervised use of vehicle equipment may cause an accident and/or serious personal injury.

### Heated steering wheel\*

The steering wheel heating warms up the leather area of the steering wheel.

The stalk with the heated steering wheel switch is on the lower left-hand side of the steering wheel.

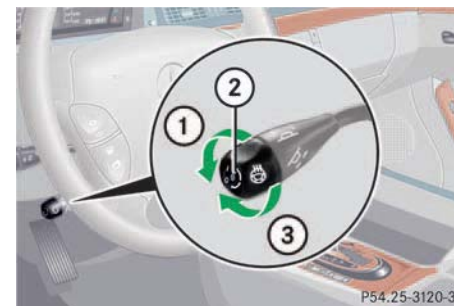

- ① Switching on
- ② Indicator lamp
- ③ Switching off

#### Switching on

- ▶ Switch on ignition.  
All the lamps in the instrument cluster should come on.
- ▶ Turn switch at the tip of stalk in the direction of arrow ①.  
The steering wheel is heated. Indicator lamp ② comes on.

#### Switching off

- ▶ Turn switch at the tip of stalk in direction of arrow ③.  
The steering wheel heating is turned off. Indicator lamp ② goes out.



The steering wheel heating does not turn off automatically.

#### Telephone\*

##### Warning!



Never operate radio transmitters equipped with a built-in or attached antenna (i.e. without being connected to an external antenna) from inside the vehicle while the engine is running. Doing so could lead to a malfunction of the vehicle's electronic system, possibly resulting in an accident and/or serious personal injury.

Radio transmitters, such as a portable telephone or a citizens band unit, should only be used inside the vehicle if they are connected to an antenna that is installed on the outside of the vehicle.

The external antenna must be approved by Mercedes-Benz. Please contact an authorized Mercedes-Benz Center for information on the installation of an approved external antenna. Refer to the radio transmitter operation instructions regarding use of an external antenna.

##### Warning!



Please do not forget that your primary responsibility is to drive the vehicle. A driver's attention to the road must always be his/her primary focus when driving. For your safety and the safety of others, we recommend that you pull over to a safe location and stop before placing or taking a telephone call.

If you choose to use the telephone<sup>1</sup> while driving, please use the hands-free device and only use the telephone when road, weather and traffic conditions permit. Some jurisdictions prohibit the driver from using a cellular telephone while driving a vehicle.

Only operate the COMAND (Cockpit Management and Data System)<sup>1</sup> if road, weather and traffic conditions permit.



<sup>1</sup> Observe all legal requirements.

## Controls in detail

### Useful features



Bear in mind that at a speed of just 30 mph (approximately 50 km/h), your vehicle is covering a distance of 44 feet (approximately 14 m) every second.

You can take and place telephone calls using the  and  buttons on the steering wheel. To carry out other telephone functions, use the control system (▷ page 134).

See separate operating manual for instructions on how to use the telephone.

### Tele Aid



The initial activation of the Tele Aid system may only be performed by completing the subscriber agreement and placing an acquaintance call using the SOS button. Failure to complete either of these steps will result in a system that is not activated. If the system is not activated, the indicator lamp in the SOS button stays on after turning the SmartKey in starter switch to position **2**, or pressing the KEYLESS-GO\* start/stop button twice to position **2**. The message TELE AID - NOT ACTIVATED will be shown in the multifunction display for approximately ten seconds.

If you have any questions regarding activation, please call the Response Center at 1-800-756-9018 (in the USA) or 1-888-923-8367 (in Canada).



### The Tele Aid system



(Telematic Alarm Identification on Demand)

The Tele Aid system consists of three types of response:

- automatic and manual emergency
- roadside assistance, and
- information



The Tele Aid system is operational providing that the vehicle's battery is charged, properly connected, not damaged and cellular and GPS coverage is available.

The speaker volume of a Tele Aid call can be adjusted when using the volume control on the multifunction steering wheel. To raise, press button  and to lower, press button .

- ▶ To activate, press the SOS button, the Roadside Assistance button  or the Information button , depending on the type of response required.



The SOS button is located above the interior rear view mirror.



The Roadside Assistance button  and the Information button  are located below the center armrest cover.

Shortly after the completion of your Tele Aid acquaintance call, you will receive a user ID and password via first call mail. By visiting [www.mbusa.com](http://www.mbusa.com) and selecting “Tele Aid” (USA only), you will have access to account information, remote door unlock, and more.



The Tele Aid system utilizes the cellular network for communication and the GPS (Global Positioning System) satellites for vehicle location. If either of these signals are unavailable, the Tele Aid system may not function and if this occurs, assistance must be summoned by other means.

### System self-check

Initially, after turning the ignition on, malfunctions are detected and indicated (the indicator lamps in the SOS button, the Roadside Assistance button  and the Information button  stay on longer than ten seconds or do not come on). The message TELE AID - DRIVE TO WORKSHOP! appears for approximately ten seconds in the multifunction display.



The Tele Aid system utilizes the cellular network for communication and the GPS (Global Positioning System) satellites for vehicle location. If either of these signals are unavailable, the Tele Aid system may not function and if this occurs, assistance must be summoned by other means.

## Controls in detail

### Useful features

#### Warning!



If the indicator lamps in the SOS button, in the Roadside Assistance button and/or in the Information button do not come on during the system self-check, or if any of these indicators remain illuminated continuously in red and/or the message TELE AID - DRIVE TO WORKSHOP! is displayed in the multifunction display after the system self-check, a malfunction in the system has been detected.

If a malfunction is indicated as outlined above, the system may not operate as expected. Have the system checked at the nearest Mercedes-Benz Center as soon as possible.

## Controls in detail

### Useful features

#### Emergency calls

An emergency call is initiated automatically:

- following an accident in which the emergency tensioning devices (ETDs) or airbags deploy
- if the anti-theft alarm or the tow-away alarm stays on for more than 20 seconds, see “Anti-theft alarm system” (▷ page 83) and tow-away alarm (▷ page 85)

An emergency call can also be initiated manually by opening the cover next to the interior rear view mirror labeled SOS, then briefly pressing the button located under the cover.

For more information, see “Initiating an emergency call manually” (▷ page 245).

Once the emergency call is in progress, the indicator lamp in the SOS button will begin to flash. The message `EMERGENCY CALL - CONNECTING CALL` appears in the multifunction display. When the connection is established, the message `EMERGENCY CALL - CALL CONNECTED` appears in the multifunction display. All information relevant to the emergency, such as the location of the vehicle (determined by the GPS satellite location system), vehicle model, identification number and color are generated.

A voice connection between the Response Center and the occupants of the vehicle will be established automatically soon after the emergency call has been initiated. When a voice connection is established, the audio system mutes and the message `TELE AID - EMERGENCY CALL ACTIVE` appears in the multifunction display. The Response Center will attempt to determine more precisely the nature of the accident provided they can speak to an occupant of the vehicle.

The Tele Aid system is available if

- it has been activated and is operational. Activation requires a subscription for monitoring services, connection, and cellular air time
- the relevant cellular phone network and GPS signals are available and pass the information on to the Response Center



Location of the vehicle on a map is only possible if the vehicle is able to receive signals from the GPS satellite network and pass the information on to the Response Center.

### Warning!



If the indicator lamp in the SOS button is illuminated continuously and there was no voice connection to the Response Center established, then the Tele Aid system could not initiate an emergency call (e.g. the relevant cellular phone network is not available). The message **EMERGENCY CALL - CALL FAILED** appears in the multifunction display for approximately ten seconds.

Should this occur, assistance must be summoned by other means.

### Initiating an emergency call manually

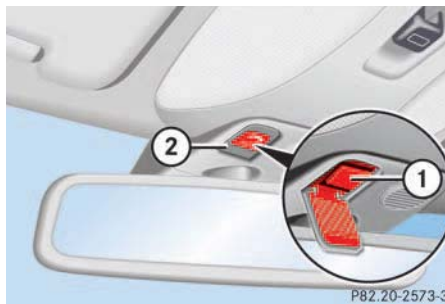

① SOS button

② Cover

- ▶ Briefly press on the cover ②.

The cover will open.

- ▶ Press SOS button ① briefly.

The indicator lamp in SOS button ① will flash until the emergency call is concluded.

## Controls in detail

### Useful features

- ▶ Wait for a voice connection to the Response Center.
- ▶ Close cover ② after the emergency call is concluded.

### Warning!





If you feel at any way in jeopardy when in the vehicle (e.g. smoke or fire in the vehicle, vehicle in a dangerous road location), please do not wait for voice contact after you have pressed the emergency button. Carefully leave the vehicle and move to a safe location. The Response Center will automatically contact local emergency officials with the vehicle's approximate location if they receive an automatic SOS signal and cannot make voice contact with the vehicle occupants.

## Controls in detail

### Useful features

#### Roadside Assistance button

The Roadside Assistance button  is located below the center armrest cover.

- ▶ Press and hold the button  (for longer than two seconds).

A call to a Mercedes-Benz Roadside Assistance dispatcher will be initiated. The button will flash while the call is in progress. The message `ROADSIDE ASSISTANCE - CONNECTING CALL` will appear in the multifunction display.

When the connection is established, the message `ROADSIDE ASSISTANCE - CALL CONNECTED` appears in the multifunction display. The Tele Aid system will transmit data generating the vehicle identification number, model, color and location (subject to availability of cellular and GPS signals).

A voice connection between the Roadside Assistance dispatcher and the occupants of the vehicle will be established. When a voice connection is established, the audio system mutes and the message `TELE AID - ROADSIDE ASSISTANCE CALL ACTIVE` appears in the multifunction display.



- ▶ Describe the nature of the need for assistance.

The Mercedes-Benz Roadside Assistance dispatcher will either dispatch a qualified Mercedes-Benz technician or arrange to tow your vehicle to the nearest authorized Mercedes-Benz Center. For services such as labor and/or towing, charges may apply. Refer to the Roadside Assistance Manual for more information.

These programs are only available in the USA:

- Sign and Drive services: Services such as jump start, a few gallons of fuel or the replacement of a flat tire with the vehicle spare tire are obtainable.
- Remote Vehicle Diagnostics: This function permits the Mercedes-Benz Roadside Assistance dispatcher to download malfunction codes and actual vehicle data.





The indicator lamp in the Roadside Assistance button  remains illuminated in red for approximately ten seconds during the system self-check after turning the ignition on (together with the SOS button and the Information button ).

## Controls in detail

### Useful features

See system self-check (▷ page 243) when the indicator lamp does not come on in red or stays on longer than approximately ten seconds.

If the indicator lamp in the Roadside Assistance button  is continuously illuminated and no voice connection to the Response Center was established, the Tele Aid system could not initiate a Roadside Assistance call (e.g. the relevant cellular phone network is not available). The message `ROADSIDE ASSISTANCE - CALL FAILED` appears in the multifunction display.

Roadside Assistance calls can be terminated using the  button on the multifunction steering wheel.

#### Information button

The Information button  is located below the center armrest cover.

- ▶ Press and hold the button  (for longer than two seconds).

A call to the Customer Assistance Center will be initiated. The button will flash while the call is in progress. The message `INFO - CONNECTING CALL` will appear in the multifunction display.

When the connection is established, the message `INFO - CALL CONNECTED` appears in the multifunction display. The Tele Aid system will transmit data generating the vehicle identification number, model, color and location (subject to availability of cellular and GPS signals).

A voice connection between the Customer Assistance Center representative and the occupants of the vehicle will be established. When a voice connection is established, the audio system mutes and the message `TELE AID - INFO CALL ACTIVE` appears in the multifunction display.

Information regarding the operation of your vehicle, the nearest authorized Mercedes-Benz Center or Mercedes-Benz USA products and services is available to you.



For more details concerning the Tele Aid system, please visit [www.mbusa.com](http://www.mbusa.com) and use your ID and password (sent to you separately) to learn more (USA only).



## Controls in detail

### Useful features



The indicator lamp on the Information button  remains illuminated in red for approximately ten seconds during the system self-check after turning the ignition on (together with the SOS button and the Roadside Assistance button .

See System self-check (> page 243) when the indicator lamp does not come on in red or stays on longer than approximately ten seconds.

If the indicator lamp in the Information button  is illuminated continuously and no voice connection to the Response Center was established, then the Tele Aid system could not initiate an Information call (e.g. the relevant cellular phone network is not available). The message INFO - CALL FAILED appears in the multifunction display.

Information calls can be terminated using the  button on the multifunction steering wheel.



If the indicator lamps do not start flashing after pressing one of the buttons or remain illuminated (in red) at any time, the Tele Aid system has detected a fault or the service is not currently active, and may not initiate a call. Visit an Mercedes-Benz Center and have the system checked or contact the Response Center at 1-800-756-9018 (in the USA) or 1-888-923-8367 (in Canada) as soon as possible.

### Upgrade Signals

The Tele Aid system processes calls using the following priority:

- Automatic emergency – First priority
- Manual emergency – Second priority
- Roadside Assistance – Third priority
- Information – Fourth priority

Should a higher priority call be initiated while you are connected, an upgrade (alternating) tone will be heard, and the appropriate indicator lamp will flash. If certain information such as vehicle identification number or customer information is not available, the operator may need to retransmit.

During this time you will hear a beep and voice contact will be interrupted. Voice contact will resume once the retransmission is completed. Once a call is concluded, a beep will be heard and the respective indicator lamp will stop flashing. The COMAND system operation will resume.

## Controls in detail

### Useful features



If the indicator lamp continues to flash or the system does not reset, contact the Response Center at 1-800-756-9018 (in the USA) or 1-888-923-8367 (in Canada), or Mercedes-Benz Customer Assistance at 1-800-FOR-MERCEdes (1-800-367-6372) in the USA or Customer Service at 1-800-387-0100 in Canada.



The indicator lamp in the respective button flashes until the call is concluded. Calls can only be terminated by a Response Center or Customer Assistance Center representative except Roadside Assistance and Information calls, which can also be terminated by pressing button  on the multifunction steering wheel.



When a Tele Aid call has been initiated, the COMAND system audio is muted and the selected mode (radio, tape or CD) pauses. The optional cellular phone (if installed) switches off. If you must use this phone, the vehicle must be parked. Disconnect the coiled cord and place the call. The COMAND navigation system (if engaged) will continue to run. The display in the instrument cluster is available for use, and spoken commands are only available by pressing the RPT button on the COMAND unit. A pop-up window will appear in the COMAND display to indicate that a Tele Aid call is in progress.

#### Remote door unlock

In case you have locked your vehicle unintentionally (e.g. SmartKey inside vehicle), and the reserve SmartKey is not handy:

- ▶ Contact the Mercedes-Benz Response Center at 1-800-756-9018 (in the USA) or 1-888-923-8367 (in Canada).

You will be asked to provide your password which you provided when you completed the subscriber agreement.

- ▶ Then return to your vehicle and press the trunk lid button for a minimum of 20 seconds until the SOS button is flashing.

The message **EMERGENCY CALL - CALL CONNECTED** appears in the multifunction display.

As an alternative, you may unlock the vehicle via Internet using the ID and password sent to you shortly after the completion of your acquaintance call.

## Controls in detail

### Useful features

The Response Center will then unlock your vehicle with the remote door unlocking feature.



The remote door unlock feature is available if the relevant cellular phone network is available.

The SOS button will flash and the message EMERGENCY CALL - CALL CONNECTED will appear in the multifunction display to indicate receipt of the door unlock command.

Once the vehicle is unlocked, a Response Center specialist will attempt to establish voice contact with the vehicle occupants.

If the trunk lid button was pressed for more than 20 seconds before door unlock authorization was received by the Response Center, you must wait 15 minutes before pressing the trunk lid button again.

### Stolen vehicle tracking services

In the event your vehicle was stolen:

- ▶ Report the incident to the police.  
The police will issue a numbered incident report.
- ▶ Pass this number on to the Mercedes-Benz Response Center along with your password issued to you when you subscribed to the service.

The Response Center will then attempt to covertly contact the vehicle's Tele Aid system. Once the vehicle is located, the Response Center will contact the local law enforcement and you. The vehicle's location will only be provided to law enforcement.

### Garage door opener

The built-in remote control is capable of operating up to three separately controlled devices, for example garage door openers, gate openers, or other devices compatible with HomeLink® or some other systems.

You can program the signal transmitter buttons.

## Controls in detail

### Useful features

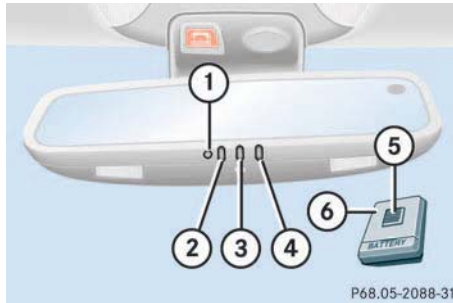

#### Remote control integrated into the interior rear view mirror

- ① Indicator lamp
- ② ③ ④ Signal transmitter button
- ⑤ Hand-held transmitter button
- ⑥ Hand-held remote control transmitter (not part of the vehicle equipment)

#### Warning!



Before programming the integrated remote control to a garage door opener or gate operator, make sure that people and objects are out of the way of the device to prevent potential harm or damage.

When programming a garage door opener, the door moves up or down. When programming a gate operator, the gate opens or closes.

Do not use the integrated remote control with any garage door opener that lacks safety stop and reverse features as required by U.S. federal safety standards (this includes any garage door opener model manufactured before April 1, 1982). A garage door that cannot detect an object - signaling the door to stop and reverse - does not meet current U.S. federal safety standards.

#### i

Certain types of garage door openers are incompatible with the integrated opener. If you should experience difficulties with programming the transmitter, contact an authorized Mercedes-Benz Center, or call Mercedes-Benz Customer Assistance Center (in the USA only) at 1-800-FOR-MERCEdes, or Customer Service (in Canada) at 1-800-387-0100.

## Controls in detail

### Useful features



For operation in the USA only:  
This device complies with Part 15 of the FCC Rules. Operation is subject to the following two conditions:

- This device may not cause harmful interference, and
- this device must accept any interference received, including interference that may cause undesired operation.

Any unauthorized modification to this device could void the user's authority to operate the equipment.

### Programming or reprogramming the integrated remote control

Step 1:

- ▶ Switch on ignition.

Step 2:

- ▶ If you have previously programmed an integrated signal transmitter button and wish to retain its programming, proceed to step 3. Otherwise, press and hold the two outer signal transmitter buttons ② and ④ and release them only when the indicator lamp begins to flash after approximately 20 seconds (do not hold the button for longer than 30 seconds). This procedure erases any previous settings for all three channels and initializes the memory. If you later wish to program a second and/or third hand-held transmitter to the remaining two signal transmitter buttons, do not repeat this step and begin directly with step 3.

Step 3:

- ▶ Hold the end of the hand-held remote control transmitter ⑥ of the device you wish to train approximately 2 to 5 in (5 cm to 12 cm) away from the surface of the integrated remote control located on the interior rear view mirror, keeping the indicator lamp ① in view.

Step 4:

- ▶ Using both hands, simultaneously press the hand-held transmitter button ⑤ and the desired integrated signal transmitter button (②, ③ or ④). Do not release the buttons until completing step 5.

The indicator lamp ① on the integrated remote control will flash, first slowly and then rapidly.

## Controls in detail

### Useful features



The indicator lamp ① flashes the first time the signal transmitter button is programmed. If this button has already been programmed, the indicator lamp will only start flashing after 20 seconds.

#### Step 5:

- ▶ When the indicator lamp ① flashes rapidly, release both buttons.

#### Step 6:

- ▶ Press and hold the just-trained integrated signal transmitter button and observe the indicator lamp ①.

If the indicator lamp ① stays on constantly, programming is complete and your device should activate when the integrated signal transmitter button is pressed and released.



If the indicator lamp ① flashes rapidly for about two seconds and then turns to a constant light, continue with programming steps 8 through 12 as your garage door opener may be equipped with the “rolling code feature”.

#### Step 7:

- ▶ To program the remaining two buttons, repeat the steps above starting with step 3.

#### **Rolling code programming**

To train a garage door opener (or other rolling code devices) with the rolling code feature, follow these instructions after completing the “Programming” portion (steps 1 through 6) of this text. (A second person may make the following training procedures quicker and easier.)

#### Step 8:

- ▶ Locate “training” button on the garage door opener motor head unit.

Exact location and color of the button may vary by garage door opener brand. Depending on manufacturer, the “training” button may also be referred to as “learn” or “smart” button. If there is difficulty locating the transmitting button, refer to the garage door opener operator’s manual.

#### Step 9:

- ▶ Press “training” button on the garage door opener motor head unit.

The “training light” is activated.

You have 30 seconds to initiate the following step.

#### Step 10:

- ▶ Firmly press, hold for two seconds and release the programmed integrated signal transmitter button (②, ③ or ④).



## Controls in detail

### Useful features

#### ▷▷Step 11:

- ▶ Press, hold for two seconds and release same button a second time to complete the training process.

Some garage door openers (or other rolling code equipped devices) may require you to perform this procedure a third time to complete the training.

#### Step 12:

- ▶ Confirm the garage door operation by pressing the programmed integrated signal transmitter button (②, ③ or ④).

#### Step 13:

- ▶ To program the remaining two buttons, repeat the steps above starting with step 3.

#### ***Gate operator/Canadian programming***

Canadian radio-frequency laws require transmitter signals to “time-out” (or quit) after several seconds of transmission which may not be long enough for the integrated signal transmitter to pick up the signal during programming. Similar to this Canadian law, some U.S. gate operators are designed to “time-out” in the same manner.

If you live in Canada or if you are having difficulties programming a gate operator (regardless of where you live) by using the programming procedures, replace step 4 with the following:

#### Step 4:

- ▶ Continue to press and hold the integrated signal transmitter button (②, ③ or ④) while you press and re-press (“cycle”) your hand-held remote control transmitter (⑥) every two seconds until the frequency signal has been learned. Upon successful training, the indicator lamp (①) will flash slowly and then rapidly after several seconds.
- ▶ Proceed with programming step 5 and step 6 to complete.

#### Operation of integrated remote control

- ▶ Switch on ignition.
- ▶ Select and press the appropriate integrated signal transmitter button (②, ③ or ④) to activate the remote controlled device.

The integrated remote control transmitter continues to send the signal as long as the button is pressed – up to 20 seconds.

#### Erasing the integrated remote control memory

- ▶ Switch on ignition.
- ▶ Simultaneously hold down the signal transmitter buttons ② and ④, for approximately 20 seconds, until the indicator lamp flashes rapidly ①. Do not hold for longer than 30 seconds.

The codes of all three channels are erased.



If you sell your vehicle, erase the codes of all three channels.

#### Reprogramming a single integrated signal transmitter button

To program a device using a signal transmitter button previously trained, follow these steps:

- ▶ Press and hold the desired signal transmitter button (②, ③ or ④). Do not release the button.
- ▶ The indicator lamp will begin to flash after 20 seconds. Without releasing the integrated signal transmitter button, proceed with programming starting with step 3.



## Controls in detail

### Useful features

#### Infrared reflecting windshield



- ① Mounting location for electronic toll collection devices (infrared transparent)
- ② Infrared transparent area (pass-through for electronic signals)
- ③ 31.5 in (80 cm)
- ④ 19.0 in (48 cm)
- ⑤ 1.75 in (4.5 cm)

Your vehicle is equipped with infrared reflecting glass which reduces the amount of radiated heat entering the interior through the windows.

The infrared reflecting glass also prevents the transmission of signals through the glass by in-vehicle electronic devices (e.g. electronic toll collection devices).

To allow the use of these devices in the vehicle, two infrared transparent areas (① and ②) are placed in the windshield.

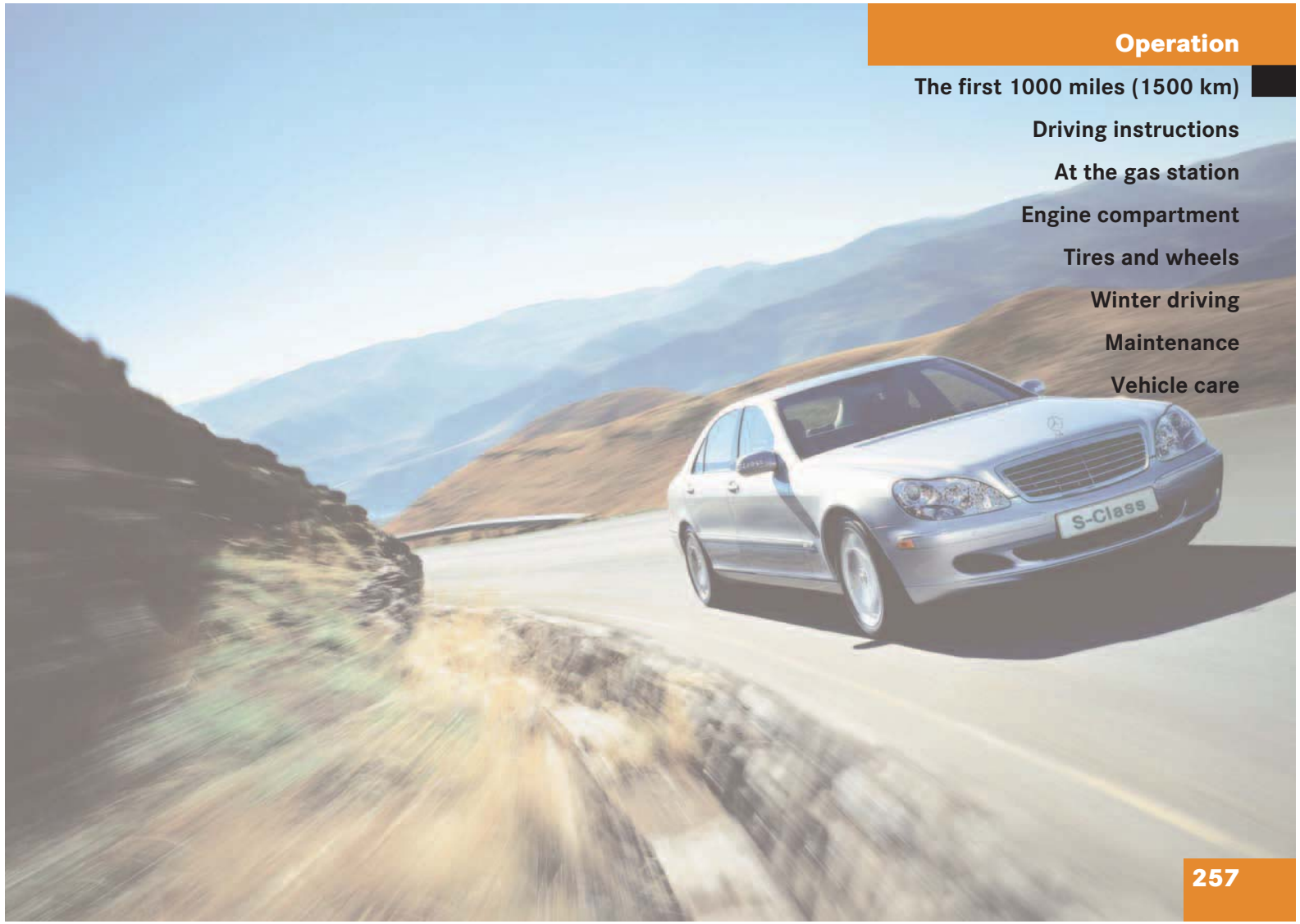

## Operation

The first 1000 miles (1500 km)

Driving instructions

At the gas station

Engine compartment

Tires and wheels

Winter driving

Maintenance

Vehicle care

## Operation

### The first 1000 miles (1500 km)

In the “Operation” section you will find detailed information on operating, maintaining and caring for your vehicle.

#### ▼ The first 1000 miles (1500 km)

The more cautiously you treat your vehicle during the break-in period, the more satisfied you will be with its performance later on.

- Drive your vehicle during the first 1000 miles (1500 km) at varying but moderate vehicle and engine speeds.
- During this period, avoid heavy loads (full throttle driving) and excessive engine speeds (no more than  $\frac{2}{3}$  of maximum rpm in each gear).
- Avoid accelerating by kick-down.
- Do not attempt to slow the vehicle down by shifting to a lower gear using the gear selector lever.
- Select positions **3**, **2** or **1** only when driving at moderate speeds (for hill driving).

After 1000 miles (1500 km) you may gradually increase vehicle and engine speeds to the permissible maximum.



Additional instructions for AMG vehicles:

- During the first 1000 miles (1500 km), do not exceed a speed of 85 mph (140 km/h).
- During this period, avoid engine speeds above 4500 rpm in each gear.

All of the above instructions, as may apply to your vehicle type, also apply when driving the first 1000 miles (1500 km) after the engine or the rear differential has been replaced.



Always obey applicable speed limits.

▼ **Driving instructions**

**Drive sensibly – save fuel**

Fuel consumption, to a great extent, depends on driving habits and operating conditions.

To save fuel you should:

- Keep tires at the recommended inflation pressures.
- Remove unnecessary loads.
- Remove roof rack when not in use.
- Allow engine to warm up under low load use.
- Avoid frequent acceleration and deceleration.
- Have all maintenance work performed at the intervals specified in the Service Booklet and as required by the FSS. Contact an authorized Mercedes-Benz Center.

Fuel consumption is also increased by driving in cold weather, in stop-and-go traffic, on short trips, and in hilly country.

**Drinking and driving**

**Warning!**



Drinking and driving and/or taking drugs and driving are very dangerous combinations. Even a small amount of alcohol or drugs can affect your reflexes, perceptions and judgement.

The possibility of a serious or even fatal accident are greatly increased when you drink or take drugs and drive.

Do not drink or take drugs and drive or allow anyone to drive who has been drinking or taking drugs.

**Pedals**

**Warning!**



Keep driver's foot area clear at all times. Objects stored in this area may impair pedal movement.

**Power assistance**

**Warning!**



With the engine not running, there is no power assistance for the brake and steering systems. In this case, it is important to keep in mind that a considerably higher degree of effort is necessary to brake and steer the vehicle.

## Operation

### Driving instructions

#### Brakes

##### Warning!



After driving in heavy rain for some time without applying the brakes or through water deep enough to wet brake components, the first braking action may be somewhat reduced and increased pedal pressure may be necessary to obtain expected braking effect. Maintain a safe distance from vehicles in front.

Resting your foot on the brake pedal will cause excessive and premature wear of the brake pads.

It can also result in the brakes overheating, thereby significantly reducing their effectiveness. It may not be possible to stop the vehicle in sufficient time to avoid an accident.

To help prevent brake disk corrosion after driving on wet road surfaces (particularly salted roads), it is advisable to brake the vehicle with considerable force prior to parking. The heat generated serves to dry the brakes.

If your brake system is normally only subjected to moderate loads, you should occasionally test the effectiveness of the brakes by applying above-normal braking pressure at higher speeds. This will also enhance the grip of the brake pads.



Be very careful not to endanger other road users when you apply the brakes.

Refer to the description of the Brake Assist System (BAS) (▷ page 78).

If the parking brake is released and the brake warning lamp in the instrument cluster stays on, the brake fluid level in the reservoir is too low.

Brake pad wear or a leak in the system may be the reason for low brake fluid in the reservoir.

Have the brake system inspected immediately. Contact an authorized Mercedes-Benz Center.

All checks and service work on the brake system should be carried out by qualified technicians only. Contact an authorized Mercedes-Benz Center.

Only install brake pads and brake fluid recommended by Mercedes-Benz.

#### Warning!



If other than recommended brake pads are installed, or other than recommended brake fluid is used, the braking properties of the vehicle can be degraded to an extent that safe braking is substantially impaired. This could result in an accident.



When driving down long and steep grades, relieve the load on the brakes by shifting into a lower gear to use the engine's braking power. This helps prevent overheating of the brakes and reduces brake pad wear.

After hard braking, it is advisable to drive on for some time, rather than immediately parking, so that the air stream can cool down the brakes faster.

#### Driving off

Apply the brakes to test them briefly after driving off. Perform this procedure only when the road is clear of other traffic.

Warm up the engine smoothly. Do not place full load on the engine until the operating temperature has been reached.

When starting off on a slippery surface, do not allow a drive wheel to spin for an extended period with the ESP switched off. Doing so may cause serious damage to the drive train which is not covered by the Mercedes-Benz Limited Warranty.



Simultaneously depressing the accelerator pedal and applying the brake reduces engine performance and causes premature brake and drivetrain wear.

#### Parking

#### Warning!



Do not park this vehicle in areas where combustible materials such as grass, hay or leaves can come into contact with the hot exhaust system, as these materials could be ignited and cause a vehicle fire.

To reduce the risk of personal injury as a result of inadvertent vehicle movement, before turning off the engine and leaving the vehicle always:

- Keep right foot on brake pedal.
- Firmly depress parking brake pedal.
- Move the gear selector lever to position **P**.
- Slowly release brake pedal.
- When parked on an incline, turn front wheel towards the road curb.



## Operation

### Driving instructions



- Turn the SmartKey to starter switch position **0** and remove, or press KEYLESS-GO\* start/stop button.
- Take the SmartKey or the SmartKey with KEYLESS-GO\* with you and lock vehicle when leaving.



Set the parking brake whenever parking or leaving the vehicle. In addition, move gear selector lever to position **P**. When parking on hills, always turn front wheels towards the road curb.

### Tires

#### Warning!



If you feel a sudden significant vibration or ride disturbance, or you suspect that possible damage to your vehicle has occurred, you should turn on the hazard warning flashers, carefully slow down, and drive with caution to an area which is a safe distance from the road.

Inspect the tires and the vehicle underbody for possible damage. If the vehicle or tires appear unsafe, have it towed to the nearest Mercedes-Benz Center or tire dealer for repairs.

Tread wear indicators (TWI) are required by law. These indicators are located in six places on the tread circumference and become visible at a tread depth of approximately  $\frac{1}{16}$  in (1.6 mm), at which point the tire is considered worn and should be replaced.

The tread wear indicator appears as a solid band across the tread.

#### Warning!



Although the applicable federal motor vehicle safety laws consider a tire to be worn when the tread wear indicators (TWI) become visible at approximately  $\frac{1}{16}$  in (1.6 mm), we recommend that you do not allow your tires to wear down to that level. As tread depth approaches  $\frac{1}{8}$  in (3 mm), the adhesion properties on a wet road are sharply reduced.

Depending upon the weather and/or road surface (conditions), the tire traction varies widely.

Specified tire pressures must be maintained. This applies particularly if the tires are subject to extreme operating conditions (e.g. high speeds, heavy loads, high ambient temperatures).

#### Warning!



Do not drive with a flat tire. A flat tire affects the ability to steer or brake the vehicle. You may lose control of the vehicle. Continued driving with a flat tire or driving at high speed with a flat tire will cause excessive heat build-up and possibly a fire.

#### Hydroplaning

Depending on the depth of the water layer on the road, hydroplaning may occur, even at low speeds and with new tires. Reduce vehicle speed, avoid track grooves in the road and apply brakes cautiously in the rain.

#### Tire traction

The safe speed on a wet, snow covered or icy road is always lower than on a dry road.

You should pay particular attention to the condition of the road whenever the outside temperatures are close to the freezing point.

#### Warning!



If ice has formed on the road, tire traction will be substantially reduced. Under such weather conditions, drive, steer and brake with extreme caution.

Mercedes-Benz recommends M+S rated radial-ply tires with a minimum tread depth of approximately  $\frac{1}{8}$  in (4 mm) on all four wheels for the winter season to ensure normal balanced handling characteristics. On packed snow, they can reduce your stopping distance in compared to summer tires. Stopping distance, however, is still

considerably greater than when the road is not covered with snow or ice. Exercise appropriate caution.

#### Tire speed rating

Regardless of the tire rating, local speed limits should be obeyed. Use prudent driving speeds appropriate to prevailing conditions.

#### Warning!



Even when permitted by law, never operate a vehicle at speeds greater than the maximum speed rating of the tires.

Exceeding the maximum speed for which tires are rated can lead to sudden tire failure, causing loss of vehicle control and possibly resulting in an accident and/or serious personal injury and possible death, for you and for others.



## Operation

### Driving instructions

#### **S 430, S 430 4MATIC, S 500, and S 500 4MATIC**

Your vehicle is factory equipped with “H”-rated tires, which have a speed rating of 130 mph (210 km/h).

An electronic speed limiter prevents your vehicle from exceeding a speed of 130 mph (210 km/h).

#### **S 600**

Your vehicle is factory equipped with “Y”-rated tires, which have a speed rating of 186 mph (300 km/h).

An electronic speed limiter prevents your vehicle from exceeding a speed of 130 mph (210 km/h).

#### **S 430, S 430 4MATIC, S 500, S 500 4MATIC, and S 600 with Sport Package\* or Appearance Package\***

Your vehicle is factory equipped with “Y”-rated tires, which have a speed rating of 186 mph (300 km/h).

An electronic speed limiter prevents your vehicle from exceeding a speed of 130 mph (210 km/h).

#### **S 55 AMG**

Your vehicle is factory equipped with “Y”-rated tires, which have a speed rating of 186 mph (300 km/h).

An electronic speed limiter prevents your vehicle from exceeding a speed of 155 mph (250 km/h).



For information on speed rating for winter tires, see “Winter tires” (▷ page 292).

### Winter driving instructions

The most important rule for slippery or icy roads is to drive sensibly and to avoid abrupt acceleration, braking and steering maneuvers. Do not use the cruise control system under such conditions.

When the vehicle is in danger of skidding, move gear selector lever to position **N**. Try to keep the vehicle under control by corrective steering action.



For information on driving with snow chains, see “Snow chains” (▷ page 293).

### Warning!



On slippery road surfaces, never downshift in order to obtain braking action. This could result in drive wheel slip and reduced vehicle control. Your vehicle’s ABS will not prevent this type of control loss.

Road salts and chemicals can adversely affect braking efficiency. Increased pedal force may become necessary to produce the normal braking effect.

Depressing the brake pedal periodically when traveling at length on salt-strewn roads can bring road-salt impaired braking efficiency back to normal.

If the vehicle is parked after being driven on salt-treated roads, the braking efficiency should be tested as soon as possible after driving is resumed.

**Warning!**



Make sure not to endanger any other road users when carrying out these braking maneuvers.

**Warning!**



If the vehicle becomes stuck in snow, make sure that snow is kept clear of the exhaust pipe and from around the vehicle with the engine running. Otherwise, deadly carbon monoxide (CO) gases may enter vehicle interior resulting in unconsciousness and death.

To assure sufficient fresh air ventilation, open a window slightly on the side of the vehicle not facing the wind.

**Warning!**



The outside temperature indicator is not designed to serve as an ice-warning device and is therefore unsuitable for that purpose. Indicated temperatures just above the freezing point do not guarantee that the road surface is free of ice.

For more information on winter driving, see “Winter driving” (▷ page 292).

**Standing water**



Do not drive through flooded areas or water of unknown depth. Before driving through water, determine its depth. Never accelerate before driving into water. The bow wave could force water into the engine and auxiliary equipment, thus damaging them.

If you must drive through standing water, drive slowly to prevent water from entering the passenger compartment or the engine compartment. Water in these areas could cause damage to electrical components or wiring of the engine or transmission, or could result in water being ingested by the engine through the air intake causing severe internal engine damage. Any such damage is not covered by the Mercedes-Benz Limited Warranty.

## Operation

### Driving instructions

#### Passenger compartment

##### Warning!



Always fasten items being carried as securely as possible.

In an accident, during hard braking or sudden maneuvers, loose items will be thrown around inside the vehicle, and cause injury to vehicle occupants unless the items are securely fastened in the vehicle.

The trunk is the preferred place to carry objects.

#### Driving abroad

Abroad, there is an extensive Mercedes-Benz service network at your disposal. If you plan to drive into areas which are not listed in the index of your Mercedes-Benz Center directory, you should request pertinent information from an authorized Mercedes-Benz Center.

#### Control and operation of radio transmitters

##### COMAND\*, radio, and telephone\*

##### Warning!



Please do not forget that your primary responsibility is to drive the vehicle safely. Only operate the COMAND (Cockpit Management and Data System), radio, or telephone<sup>1</sup> if road, weather and traffic conditions permit.

Bear in mind that at a speed of just 30 mph (approximately 50 km/h), your vehicle is covering a distance of 44 feet (approximately 14 m) every second.

<sup>1</sup> Observe all legal requirements.

#### Telephones and two-way radios

##### Warning!



Never operate radio transmitters equipped with a built-in or attached antenna (i.e. without being connected to an external antenna) from inside the vehicle while the engine is running. Doing so could lead to a malfunction of the vehicle's electronic system, possibly resulting in an accident and/or personal injury.

Radio transmitters, such as a portable telephone or a citizens band unit should only be used inside the vehicle if they are connected to an antenna that is installed on the outside of the vehicle.

Refer to the radio transmitter operation instructions regarding use of an external antenna.

#### Catalytic converter

Your Mercedes-Benz is equipped with monolithic-type catalytic converters, an important element in conjunction with the oxygen sensors to achieve substantial control of the pollutants in the exhaust emissions. Keep your vehicle in proper operating condition by following our recommended maintenance instructions as outlined in your Service Booklet.



To prevent damage to the catalytic converters, only use premium unleaded gasoline in this vehicle.

Any noticeable irregularities in engine operation should be repaired promptly. Otherwise, excessive unburned fuel may reach the catalytic converter, causing it to overheat and start a fire.

#### Warning!



As with any vehicle, do not idle, park or operate this vehicle in areas where combustible materials such as grass, hay or leaves can come into contact with the hot exhaust system, as these materials could be ignited and cause a vehicle fire.

#### Emission control

Certain systems of the engine serve to keep the toxic components of the exhaust gases within permissible limits required by law.

These systems, of course, will function properly only when maintained strictly according to factory specifications. Any adjustments on the engine should, therefore, be carried out only by qualified Mercedes-Benz Center authorized technicians.

Engine adjustments should not be altered in any way. Moreover, the specified service jobs must be carried out regularly according to Mercedes-Benz servicing requirements. For details refer to the Service Booklet.

## Operation

### Driving instructions

#### Warning!



Inhalation of exhaust gas is hazardous to your health. All exhaust gas contains carbon monoxide, and inhaling it can cause unconsciousness and lead to death.

Do not run the engine in confined areas (such as a garage) which are not properly ventilated. If you think that exhaust gas fumes are entering the vehicle while driving, have the cause determined and corrected immediately. If you must drive under these conditions, drive only with at least one window fully open at all times.

#### Coolant temperature

During severe operating conditions, e.g. stop-and-go traffic, the coolant temperature may rise close to approximately 248°F (120°C).

The engine should not be operated with the coolant temperature over 248°F (120°C). Doing so may cause serious engine damage which is not covered by the Mercedes-Benz Limited Warranty.

#### Warning!



- Driving when your engine is badly overheated can cause some fluids, which may have leaked into the engine compartment, to catch fire. You could be seriously burned.
- Steam from an overheated engine can cause serious burns and can occur just by opening the hood. Stay away from the engine if you see or hear steam coming from it.

Turn off the engine, get out of the vehicle and do not stand near the vehicle until the engine has cooled down.

## ▼ At the gas station

### Refueling

#### Warning!



Gasoline is highly flammable and poisonous. It burns violently and can cause serious injury. Whenever you are around gasoline, avoid inhaling fumes and skin contact, extinguish all smoking materials. Never allow sparks, flame or smoking materials near gasoline!

The fuel filler flap is located on the right-hand side of the vehicle towards the rear. Locking/unlocking the vehicle with the SmartKey or the SmartKey with KEYLESS-GO\* automatically locks/unlocks the fuel filler flap.

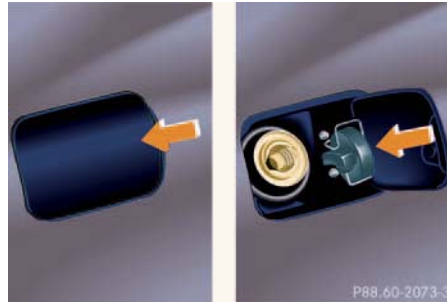

- ▶ Turn the engine off
  - by turning the SmartKey to position **0**. Remove the SmartKey from the starter switch.
  - by pressing the KEYLESS-GO\* start/stop button. Open the driver's door (with the driver's door

## Operation

### At the gas station

open, starter switch is now in position **0**, same as SmartKey removed from starter switch).

- ▶ Open the fuel filler flap by pushing at the point indicated by the arrow.

The fuel filler flap springs open.

- ▶ Turn the fuel cap to the left and hold on to it until possible pressure is released.
- ▶ Take off the cap and set it in the recess on the fuel filler flap.

To prevent fuel vapors from escaping into open air, fully insert filler nozzle unit.

- ▶ Only fill your tank until the filler nozzle unit cuts out – **do not top up or overfill**. ▷▷

## Operation

### At the gas station



#### Warning!



Overfilling of the fuel tank may create pressure in the system which could cause a gas discharge. This could cause the gas to spray back out when removing the fuel pump nozzle, which could cause personal injury.

- ▶ Replace the fuel cap by turning it to the right.  
You will hear when the fuel cap is tightened.
- ▶ Close the fuel filler flap.



Only use premium unleaded gasoline with a minimum Posted Octane Rating of 91 (average of 96 RON / 86 MON).

Information on gasoline quality can normally be found on the fuel pump.

More information on gasoline can be found in the Factory Approved Service Products pamphlet.



Leaving the engine running and the fuel cap open can cause the **CHECK ENGINE** malfunction indicator lamp to illuminate.

For more information, see the “Practical hints” section (▶ page 306).

### Check regularly and before a long trip

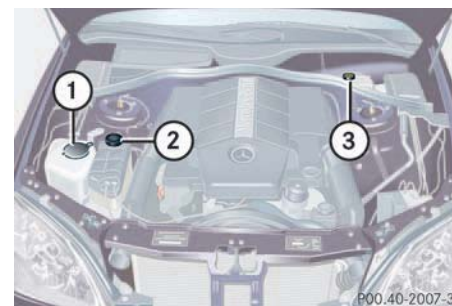

- ① Windshield washer and headlamp cleaning system\*
- ② Coolant level
- ③ Brake fluid



Opening the hood, see (▶ page 272).

**Windshield washer system and headlamp cleaning system\***

For more information on refilling the washer reservoir, see “Windshield washer system and headlamp cleaning system\*” (▷ page 281).

**Coolant**

For more information on coolant, see “Coolant” (▷ page 278) and see “Fuels, coolants, lubricants, etc.” (▷ page 391).

**Brake fluid**

If you find that the brake fluid in the brake fluid reservoir has fallen to the minimum mark or below, have the brake system checked for brake pad thickness and leaks immediately. Notify an authorized Mercedes-Benz Center immediately. Do not add brake fluid as this will not solve the problem. For more information, see “Practical hints” (▷ page 305).

For information on brake fluid, see “Brake fluid” (▷ page 394)

**Engine oil level**

For more information on engine oil, see “Engine oil” (▷ page 273).

**Vehicle lighting**

Check function and cleanliness. For more information on replacing light bulbs, see “Replacing bulbs” (▷ page 353).

For more information, see “Switching on headlamps” (▷ page 47).

**Tire inflation pressure**

For information on tire inflation pressure, see “Checking tire inflation pressure” (▷ page 283).



## Operation

### Engine compartment

#### ▼ Engine compartment

##### Hood

###### Warning!



Do not pull the release lever while the vehicle is in motion. Otherwise the hood could be forced open by passing air flow.

##### Opening

The hood lock release lever is located in the driver's footwell to the left of the parking brake pedal.

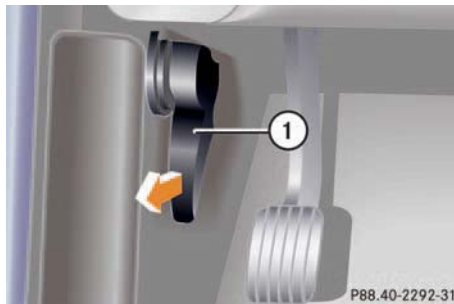

① Release lever

- ▶ Pull release lever ① in direction of arrow.

The hood is unlocked and handle ② will extend out of the radiator grille.



To avoid damage to the windshield wipers or hood, never open the hood if the wiper arms are folded forward away from the windshield.

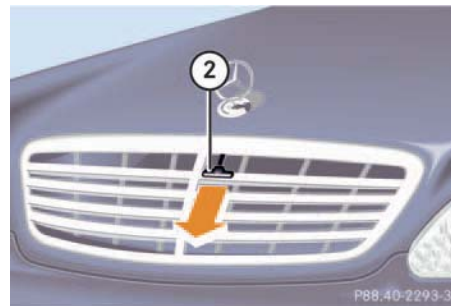

② Handle for opening the hood

- ▶ Pull handle ② to its stop out of radiator grille.
- ▶ Pull up on the hood (do not pull up on the handle) and then release it.

The hood will be automatically held open at shoulder height by gas-filled struts.

###### Warning!



To help prevent personal injury, stay clear of moving parts when the hood is open and the engine is running. Make sure the hood is properly closed before driving. When closing the hood, use extreme caution not to catch hands or fingers.

The radiator fan may continue to run for approximately 30 seconds or even restart after the engine has been turned off. Stay clear of fan blades.

#### Warning!



If you see flames or smoke coming from the engine compartment, or if the coolant temperature gauge indicates that the engine is overheated, do not open the hood. Move away from vehicle and do not open the hood until the engine has cooled down. If necessary, call the fire department.

#### Warning!



The engine is equipped with a transistorized ignition system. Because of the high voltage it is dangerous to touch any components (ignition coils, spark plug sockets, diagnostic socket) of the ignition system

- with the engine running
- while starting the engine
- if ignition is “on” and the engine is cranked manually

#### Closing

#### Warning!



Be careful that you do not close the hood on anyone.

- ▶ Let the hood drop from a height of approximately 1 ft. (30 cm).  
The hood will lock audibly.
- ▶ Check to make sure the hood is fully closed.

If you can raise the hood at a point above the headlamps, then it is not properly closed. Open it again and let it drop with somewhat greater force.

#### Engine oil

The amount of oil your engine needs will depend on a number of factors, including driving style. Higher oil consumption can occur when

- the vehicle is new
- the vehicle is driven frequently at higher engine speeds

Engine oil consumption checks should only be made after the vehicle break-in period.



Do not use any special lubricant additives, as these may damage the drive assemblies. Using special additives not approved by Mercedes-Benz will restrict your warranty entitlement.

More information on this subject is available at any Mercedes-Benz Center.

## Operation

### Engine compartment

#### Checking the engine oil level with the control system



When checking the oil level the vehicle must

- be parked on level ground
- be at normal operating temperature
- have been stationary for at least five minutes with the engine turned off

To check the engine oil level via the multifunction display, do the following:

- ▶ Turn the SmartKey in the starter switch to position **2** or press the KEYLESS-GO start/stop button\* twice.

The standard display (▷ page 139) should appear in the multifunction display.

- ▶ Press button  or  on the steering wheel until the following message is seen in the multifunction display:

CORRECT MEASUREMENT  
ONLY IF VEH. LEVEL

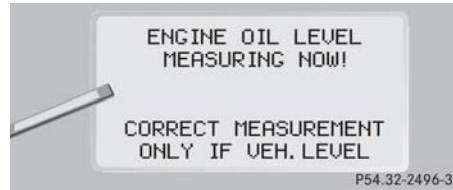

After about three seconds this message is displayed:



ENGINE OIL LEVEL  
MEASURING NOW!

One of the following messages will subsequently appear in the indicator:

- ENGINE OIL LEVEL  
OK
- ADD 1.0 QT. TO  
REACH MAX. OIL LEVEL!  
(Canada: 1.0 LITER)

- ADD 1.5 QTS. TO  
REACH MAX. OIL LEVEL!  
(Canada: 1.5 LITERS)
- ADD 2.0 QTS.  
TO REACH MAX. OIL LEVEL!  
(Canada: 2.0 LITERS)



If you want to interrupt the checking procedure, press the  or  button on the multifunction steering wheel.

- ▶ If necessary, add engine oil.

For adding engine oil see (▷ page 277).

For more information on engine oil, see the “Technical data” section (▷ page 391) and (▷ page 393).

### Other display messages

If the SmartKey or KEYLESS-GO start/stop button\* is not in position **2**, the following message will appear:

FOR ENGINE OIL LEVEL  
IGNITION ON!

- ▶ Switch on ignition.

If you see the message:

PERF. SERV. ON TIME

- ▶ If engine is at normal operating temperature, wait five minutes before repeating check procedure.
- ▶ If engine is not yet at normal operating temperature, wait 30 minutes before repeating check procedure.

If you see the message:

ENGINE OIL LEVEL  
NOT WHEN ENGINE ON!

- ▶ Turn off the engine.
- ▶ If the engine is at normal operating temperature, wait five minutes before checking oil.
- ▶ If the engine is not yet at normal operating temperature, you must wait 30 minutes before checking oil.

If there is excess engine oil with the engine at normal operating temperature, the following message will appear:

ENGINE OIL LEVEL  
REDUCE OIL LEVEL

- ▶ Have excess oil siphoned or drained off. Contact an authorized Mercedes-Benz Center.

## Operation

### Engine compartment



Excess oil must be siphoned or drained off. It could cause damage to the engine and catalytic converter not covered by the Mercedes-Benz Limited Warranty.



Perform the engine oil level check with the dipstick (S 430, S 500, and S 55 AMG only) if it cannot be completed with the control system .

In this case we recommend that you have the system checked at a Mercedes-Benz Center.

For more information on messages in the display concerning engine oil , see the “Practical hints” section (▷ page 326).

## Operation

### Engine compartment

#### Checking the engine oil level with the oil dipstick (S 430, S 500, and S 55 AMG only)

When checking the oil level the vehicle must

- be parked on level ground
- be at normal operating temperature
- have been stationary for at least five minutes with the engine turned off



The engine oil level can be checked by either the oil dipstick or via the multifunction display in the instrument cluster (▷ page 274). The amount of engine oil needed is shown more precisely in the multifunction display.

To check the engine oil level with the oil dipstick, do the following:

- ▶ Open the hood (▷ page 272).
- ▶ Pull out oil dipstick ① (▷ page 277).
- ▶ Wipe oil dipstick ① clean.

- ▶ Fully insert oil dipstick ① into the dipstick guide tube.
- ▶ Pull out oil dipstick ① again after approximately three seconds to obtain accurate reading.

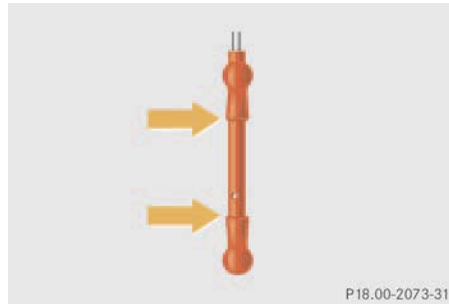

P18.00-2073-31

#### Oil dipstick

The oil level is correct when it is between the lower (min) and upper (max) mark of the oil dipstick.



The filling quantity between the upper and lower marks on the oil dipstick is approximately 2.1 US qt. (2.0 l).

- ▶ If necessary, add engine oil.

For adding engine oil see (▷ page 277).

For more information on engine, see the “Technical data” section (▷ page 391) and (▷ page 393).

For more information on messages in the display concerning engine oil, see the “Practical hints” section (▷ page 326).

## Adding engine oil



Only use approved engine oils. For a listing of approved engine oils, refer to the Factory Approved Service Products pamphlet in your vehicle literature portfolio.

In addition, check the oil filler cap for important information pertaining to the engine oil needing to meet a specific Mercedes-Benz specification (e.g. MB 229.5). If such information is printed on the oil filler cap, only use an engine oil from the list of approved engine oils in the Factory Approved Service Products pamphlet that meets the specification indicated on the oil filler cap.

Using engine oils of other specification may cause the FSS to incorrectly determine the next service interval and will result in engine damage not covered by the Mercedes-Benz Limited Warranty.

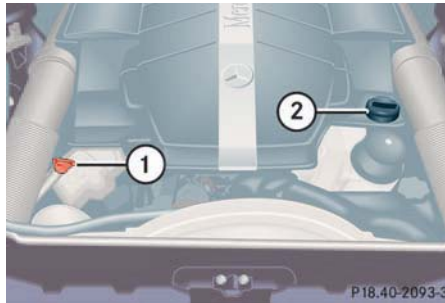

### S 430, S 430 4MATIC, S 500, S 500 4MATIC, and S 55 AMG

- ① Oil dipstick (S 430, S 500, and S 55 AMG only)
- ② Filler cap

- ▶ Unscrew filler cap ② from filler neck.
- ▶ Add engine oil as required. Be careful not to overfill with oil.

Be careful not to spill any oil when adding. Avoid environmental damage caused by oil entering the ground or water.

## Operation

### Engine compartment



Excess oil must be siphoned or drained off. It could cause damage to the engine and catalytic converter not covered by the Mercedes-Benz Limited Warranty.

- ▶ Screw filler cap ② back on filler neck.



### S 600

- ① Filler cap

- ▶ Unscrew filler cap ① from filler neck.
- ▶ Add engine oil as required. Be careful not to overfill with oil.



## Operation

### Engine compartment

- ▷▷ Be careful not to spill any oil when adding. Avoid environmental damage caused by oil entering the ground or water.



Excess oil must be siphoned or drained off. It could cause damage to the engine and catalytic converter not covered by the Mercedes-Benz Limited Warranty.

- ▶ Screw filler cap ① back on filler neck. For more information on engine, see the “Technical data” section (▷ page 391) and (▷ page 393).

### Transmission fluid level

The transmission fluid level does not need to be checked. If you notice transmission fluid loss or gear shifting malfunctions, have an authorized Mercedes-Benz Center check the automatic transmission.

### Active Body Control\* (ABC\*) fluid level

Regular fluid level check is not required. If you notice fluid leaks or malfunction messages in the multifunction display, have an authorized Mercedes-Benz Center check the ABC-system.

### Coolant

The engine coolant is a mixture of water and anticorrosion/antifreeze.

When checking the coolant level,

- the vehicle must be parked on level ground, and
- the engine must be cool.

## Warning!



In order to avoid any possibly serious burns:

- Use extreme caution when opening the hood if there are any signs of steam or coolant leaking from the cooling system, or if the coolant temperature gauge indicates that the coolant is overheated.
- Do not remove pressure cap on coolant reservoir if engine temperature is above 158°F (70°C). Allow engine to cool down before removing cap. The coolant reservoir contains hot fluid and is under pressure.
- Using a rag, slowly open the cap approximately  $\frac{1}{2}$  turn to relieve excess pressure. If opened immediately, scalding hot fluid and steam will be blown out under pressure.
- Do not spill antifreeze on hot engine parts. Antifreeze contains ethylene glycol which may burn if it comes into contact with hot engine parts.

The coolant expansion tank is located on the passenger side of the engine compartment.

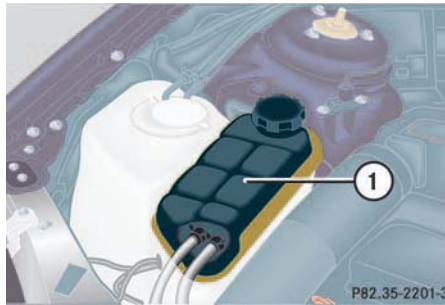

- ① Coolant expansion tank
- ▶ Using a rag, turn the cap slowly approximately one half turn to the left to release any excess pressure.
  - ▶ Continue turning the cap to the left and remove it.

## Operation

### Engine compartment



S 600:

Only open the cap on coolant expansion tank ①. Never open the cap between the charge-air coolers. Otherwise, the engine could be damaged.

The coolant level is correct if the level

- for cold coolant: reaches the black top part of the reservoir
  - for warm coolant: is approximately 0.6 in (1.5 cm) higher
- ▶ Add coolant as required.
  - ▶ Replace and tighten cap.

For more information on coolant, see “Coolants” (▷ page 395).



## Operation

### Engine compartment

#### Battery

Your vehicle's battery is located on the right side of the trunk floor (▷ page 366).

The battery should always be sufficiently charged in order to achieve its rated service life. Refer to Service Booklet for battery maintenance intervals.

If you use your vehicle mostly for short-distance trips, you will need to have the battery charge checked more frequently.

When replacing the battery, always use batteries approved by Mercedes-Benz.

If you do not intend to operate your vehicle for an extended period of time, consult an authorized Mercedes-Benz Center about steps you need to observe.



Observe all safety instructions and precautions when handling automotive batteries.



Risk of explosion



Keep flames or sparks away from battery. Do not smoke.



Battery acid is caustic. Do not allow it to come into contact with skin, eyes or clothing.

In case it does, immediately flush affected area with clear water and seek medical help if necessary.



Wear eye protection.



Keep children away.



Follow the instructions in this Operator's Manual.

Batteries contain materials that can harm the environment if disposed of improperly. Recycling of batteries is the preferred method of disposal. Many states require sellers of batteries to accept old batteries for recycling.

### Windshield washer system and headlamp cleaning system\*

The windshield washer reservoir is located in the engine compartment.

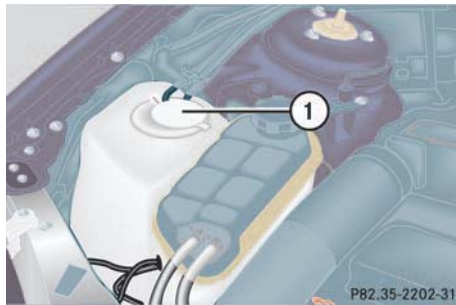

① Washer fluid reservoir

Fluid for the windshield washer system and the headlamp cleaning system is supplied from the windshield washer reservoir. It has a capacity of approximately:

- 3.2 US qt. (3.0 l) in vehicles without headlamp cleaning system
- 7.1 US qt. (6.7 l) in vehicles with headlamp cleaning system or heated reservoir

During all seasons, add MB Windshield Washer Concentrate “S” to water. Premix the windshield washer fluid in a suitable container.

- ▶ Refill the reservoir with MB Windshield Washer Concentrate and water (or commercially available premixed windshield washer solvent / antifreeze, depending on ambient temperatures).

Always use washer solvent/antifreeze where temperatures may fall below freezing point. Failure to do so could result in damage to the washer system/reservoir.

#### Warning!



Washer solvent /antifreeze is highly flammable. Do not spill washer solvent /antifreeze on hot engine parts, because it may ignite and burn. You could be seriously burned.

## Operation

### Engine compartment



Only use washer fluid which is suitable for plastic lenses. Improper washer fluid can damage the plastic lenses of the headlamps.



If the windshield washer system on your vehicle is heated\*, a fluid mixture produced to resist freezing at temperatures of approximately 14°F (-10°C) should be sufficient.

For more information, see “Windshield and headlamp washer system” (▷ page 398).

## Operation

### Tires and wheels

#### ▼ Tires and wheels

See an authorized Mercedes-Benz Center for information on tested and recommended rims and tires for summer and winter operation. They can also offer advice concerning tire service and purchase.

#### Warning!



Replace rims or tires with the same designation, manufacturer and type as shown on the original part. See an authorized Mercedes-Benz Center for further information. If incorrectly sized rims and tires are mounted:

- The wheel brakes or suspension components can be damaged.
- The correct operating clearance of the wheels and the tires are no longer guaranteed.

#### Warning!



Worn, old tires can cause accidents. If the tire tread is badly worn, or if the tires have sustained damage, replace them.

When replacing rims, use only genuine Mercedes-Benz wheel bolts specified for the particular rim type. Failure to do so can result in the bolts loosening and possibly an accident.

Retreaded tires are not tested or recommended by Mercedes-Benz, since previous damage cannot always be recognized on retreads. Mercedes-Benz can therefore not assure the operating safety of the vehicle when such tires are used.

See an authorized Mercedes-Benz Center for information on tested and recommended rims and tires for summer and winter operation.

#### Important guidelines

- Only use sets of tires and rims of the same type and make.
- Tires must be of the correct size for the rim.
- Break in new tires for approximately 60 miles (100 km) at moderate speeds.
- Regularly check the tires and rims for damage. Dented or bent rims can cause tire pressure loss and damage to the tire beads.
- If vehicle is heavily loaded, check tire pressure and correct as required.
- Do not allow your tires to wear down too far. Adhesion properties on wet roads are sharply reduced at tread depths under  $\frac{1}{8}$  in (3 mm).
- When replacing individual tires, you should mount new tires on the front wheels first (on vehicles with same-sized wheels all around).

#### Life of tires

The service life of a tire is dependent upon varying factors including but not limited to:

- Driving style
- Tire pressure
- Distance driven

#### Warning!



Tires and spare tire should be replaced after six years, regardless of the remaining tread.



Keep unmounted tires in a cool, dry place with as little exposure to light as possible. Protect tires from contact with oil, grease and gasoline.

#### Direction of rotation

Unidirectional tires offer added advantages, such as better hydroplaning performance. To benefit, however, you must make sure the tires rotate in the direction specified.

An arrow on the sidewall indicates the intended direction of tire rotation.

#### Checking tire inflation pressure

#### Warning!



If the tire pressure drops repeatedly:

- Check the tires for punctures from foreign objects.
- Check to see whether air is leaking from the valves or from around the rim.

Regularly check your tire pressure at intervals of no more than 14 days.

Correct the tire pressure only when tires are cold.

If the tires are warm, you should only correct the tire pressure if it is too low for current operating conditions.

A table on the fuel filler flap lists the specified tire inflation pressures for warm and cold tires as well as for various operating conditions.

## Operation

### Tires and wheels



The pressures listed for light loads are minimum values offering high driving comfort.

Increased inflation pressures listed for heavier loads may also be used for light loads. These higher pressures produce favorable handling characteristics. The ride of the vehicle, however, will be somewhat harder. Never exceed the max. values or inflate tires below the min. values listed on the fuel filler flap.

Tire pressure changes by approximately 1.5 psi (0.1 bar) per 18°F (10°C) of air temperature change. Keep this in mind when checking tire pressure where the temperature is different from the outside temperature.

Tire temperature and tire pressure also increase while driving, depending on the driving speed and the tire load.

#### Warning!



Follow recommended tire inflation pressures.

Do not overinflate tires. Overinflating tires can result in sudden deflation (blowout) because they are more likely to become punctured or damaged by road debris, potholes, etc.

Do not underinflate tires. Underinflated tires wear unevenly, adversely affect handling and fuel economy, and are more likely to fail from being overheated.

Do not overload the tires by exceeding the specified vehicle capacity weight (as indicated by the label on the pillar in the driver's door opening). Overloading the tires can overheat them, possibly causing a blowout.

Check the spare tire periodically for condition and inflation pressure. Spare tires will age and become worn over time even if never used, and thus should be inspected and replaced when necessary or after a maximum of six years.

### Checking tire pressure electronically\* (vehicles produced up to approximately October 2003)





**i** Check with an authorized Mercedes-Benz Center to determine the equipment installed in your vehicle.

The tire inflation pressure monitor only functions on wheels that are equipped with the proper electronic sensors. It monitors the tire inflation pressure, as selected by the driver, in all four tires. A warning is issued to alert you to a decrease in pressure in one or more of the tires.

Tire pressure inquiries are made using the multifunction display (▷ page 134). The inflation pressures are displayed only after a few minutes travel time.

You can select the unit of measure used for the tire inflation pressure by changing the setting in the control system (▷ page 134).

**i** Possible differences between the readings of a tire pressure gauge of an air hose, e.g. gas station equipment, and the vehicle's control system can occur. The readings issued by the control system are more precise.

- ▶ Switch on ignition.
- ▶ Press button  or  on the multifunction steering wheel repeatedly until the standard display menu appears in the multifunction display (▷ page 134).
- ▶ Press button  or  repeatedly until you see the current inflation pressures for each tire appear in the display.



## Operation

### Tires and wheels

#### Warning!



The tire inflation pressure monitor does not indicate a warning for wrongly selected inflation pressures. Always adjust tire inflation pressure according to the label on the fuel filler flap.

The tire inflation pressure monitor is not able to issue a warning due to a sudden dramatic loss of pressure (e.g. tire blowout caused by a foreign object). In this case bring the vehicle to a halt by carefully applying the brakes and avoiding abrupt steering maneuvers.

**i** Operating radio transmission equipment (e.g. wireless headsets, two-way radios) in or near the vehicle could cause the tire inflation pressure monitor to malfunction.

## Operation

### Tires and wheels

#### Warning!



Follow recommended tire inflation pressures.



Do not overinflate tires. Overinflating tires can result in sudden deflation (blowout) because they are more likely to become punctured or damaged by road debris, potholes, etc.



Do not underinflate tires. Underinflated tires wear unevenly, adversely affect handling and fuel economy, and are more likely to fail from being overheated.

Do not overload the tires by exceeding the specified vehicle capacity weight (as indicated by the label on the pillar in the driver's door opening). Overloading the tires can overheat them, possibly causing a blowout.

#### Activating the tire inflation pressure monitor

You must activate the tire inflation pressure monitor in the following cases:

- If you have changed the tire pressure
  - If you have replaced the wheels or tires
  - If you have installed new wheels or tires
- ▶ Make sure the tire pressure is correctly set.
- ▶ Press button  or  on the multifunction steering wheel repeatedly until the standard display menu appears in the multifunction display (▶ page 134).

- ▶ Press button  or  repeatedly until you see the current inflation pressures for each tire appear in the display or the following message appears in the display
- ```
TIRE PRES.  
DISPLAY AFTER DRIVING  
A FEW MINS.  
REACTIVATE USING  
R-BUTTON
```

#### i

If transporting a deflated road wheel or additional wheel sensors in the vehicle, the tire inflation pressure monitor should not be reactivated until the deflated wheel or additional wheel sensors have been removed from the vehicle. Otherwise, the deflated wheel or additional sensors could cause the tire inflation pressure monitor system to malfunction.

- ▶ Press the reset button on the instrument cluster (▷ page 22).

The following message will appear in the multifunction display:

MONITOR CURRENT TIRE PRESSURE

- ▶ Press **+** button.

The following message will appear in the multifunction display:

TIRE PRESS. CONTROL ACTIVATED!

The tire inflation pressure monitor will now monitor the tire inflation pressure values of all four tires.

The following message will appear in the multifunction display:

TIRE PRES.  
DISPLAY AFTER DRIVING  
A FEW MINS.  
REACTIVATE USING  
R-BUTTON

This display appears until the individual inflation pressure values are matched with the tires. The individual values are then displayed (▷ page 285).

If you wish to cancel activation:

- ▶ Press **-** button.

If the following message appears in the multifunction display:

REACTIVATE TIRE  
PRES. MONITOR  
or  
TIRE PRES.  
CHECK TIRES!

- ▶ Check the tire inflation pressures and correct them if necessary.
- ▶ Reactivate the tire inflation pressure monitor.

## Operation

### Tires and wheels

#### Checking tire pressure electronically\* (vehicles produced as of approximately October 2003)



Check with an authorized Mercedes-Benz Center to determine the equipment installed in your vehicle.

The tire inflation pressure monitor only functions on wheels that are equipped with the proper electronic sensors. It monitors the tire inflation pressure, as selected by the driver, in all four tires. A warning is issued to alert you to a decrease in pressure in one or more of the tires.

You can call up the tire pressure using the control system (▷ page 134).



## Operation

### Tires and wheels



After you have reactivated the tire pressure monitor, the current tire pressures will only be shown after a few minutes' driving time.

During this time, you will see the following message in the display:

TIRE PRES. DISPLAY  
APPEARS AFTER  
DRIVING A FEW MINUTES



Possible differences between the readings of a tire pressure gauge of an air hose, e.g. gas station equipment, and the vehicle's control system can occur. The readings issued by the control system are more precise.

- ▶ Switch on ignition.
- ▶ Press button or on the multifunction steering wheel repeatedly until the standard display menu appears in the multifunction display (▷ page 134).
- ▶ Press button or repeatedly until you see the current inflation pressures for each tire appear in the display.

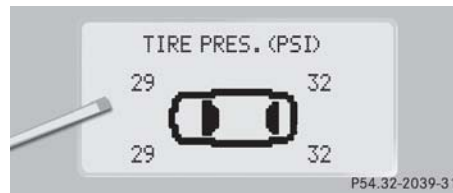

### Warning!



When the tire pressure monitoring system warning lamp is lit, one or more of your tires is significantly under-inflated. You should stop and check your tires as soon as possible, and inflate them to the proper pressure as indicated on the vehicle's tire information placard. Driving on a significantly under-inflated tire causes the tire to overheat and can lead to tire failure. Under-inflation also reduces fuel efficiency and tire tread life, and may affect the vehicle's handling and stopping ability. Each tire, including the spare, should be checked monthly when cold and set to the recommended inflation pressure as specified in the vehicle placard and owner's manual.



The recommended tire inflation pressures for your vehicle can be found on the inside of the fuel filler flap, not in the owner's manual.

### Warning!



The tire inflation pressure monitor does not indicate a warning for wrongly selected inflation pressures. Always adjust tire inflation pressure according to the label on the fuel filler flap.

The tire inflation pressure monitor is not able to issue a warning due to a sudden dramatic loss of pressure (e.g. tire blowout caused by a foreign object). In this case bring the vehicle to a halt by carefully applying the brakes and avoiding abrupt steering maneuvers.



Operating radio transmission equipment (e.g. wireless headsets, two-way radios) in or near the vehicle could cause the tire inflation pressure monitor to malfunction.

### Warning!



Follow recommended tire inflation pressures.

Do not overinflate tires. Overinflating tires can result in sudden deflation (blowout) because they are more likely to become punctured or damaged by road debris, potholes, etc.

Do not underinflate tires. Underinflated tires wear unevenly, adversely affect handling and fuel economy, and are more likely to fail from being overheated.



Do not overload the tires by exceeding the specified vehicle capacity weight (as indicated by the label on the pillar in the driver's door opening). Overloading the tires can overheat them, possibly causing a blowout.

## Operation

### Tires and wheels

#### **Reactivating the tire pressure monitor**

The tire pressure monitor must be reactivated in the following situations:

- If you have changed the tire pressure
  - If you have replaced the wheels or tires
  - If you have installed new wheels or tires
- ▶ Using the table on the fuel filler flap, make sure the tire inflation pressure of all four tires is correct.
- ▶ Press button  or  repeatedly until you see the current inflation pressures for each tire appear in the display or the following message appears in the display
- TIRE PRES. DISPLAY  
APPEARS AFTER  
DRIVING A FEW MINUTES

## Operation

### Tires and wheels



If you are transporting a deflated tire in the vehicle, do not activate the tire inflation pressure monitor until

- the deflated tire is no longer in the vehicle
- you have inflated the tire to the correct pressure

- ▶ Press the reset button on the instrument cluster (▷ page 22).

The following message will appear in the multifunction display:  
CHECK CURRENT TIRE PRES.?

- ▶ Press **+** button.

The following message will appear in the multifunction display:  
TIRE PRES. MONITOR REACTIVATED

The tire inflation pressure monitor will now monitor the tire inflation pressure values of all four tires.

Afterward, the following message will appear in the display:  
TIRE PRES. DISPLAY  
APPEARS AFTER  
DRIVING A FEW MINUTES

This display appears until the individual inflation pressure values are matched with the tires. The individual values are then displayed (▷ page 287).

If you wish to cancel activation:

- ▶ Press **-** button.

If one of the following messages appears in the multifunction display:

- TIRE PRES. MONITOR  
REACTIVATE AFTER  
CORRECTING PRESSURE!
  - TIRE PRES.  
PLEASE CORRECT!
- ▶ Check the tire inflation pressures and correct them if necessary.
  - ▶ Reactivate the tire inflation pressure monitor.

## Rotating wheels

### Warning!



Rotate front and rear wheels only if they are of the same size.

On vehicles with the same wheel size all around, wheels can be rotated every 3000 to 6000 miles (5000 to 10000 km), or sooner if necessary, according to the degree of tire wear. The same direction of tire rotation must be retained.

Rotate the wheels before the characteristic tire wear pattern becomes visible (shoulder wear on front wheels and tread center wear on rear wheels).

Thoroughly clean the inner side of the wheels after each rotation. Check and ensure proper tire inflation pressure. If necessary, activate the tire inflation pressure monitor.



Your vehicle is equipped with a tire inflation pressure monitor, there are electronic components built into the wheel.

Do not use mounting tools in the area of the valve as they could damage the electronic components.

To prevent damage or incorrect installation, have the tires changed at an authorized Mercedes-Benz Center.

## Operation

### Tires and wheels

### Warning!



Have the tightening torque checked after changing a wheel. Wheels could become loose if not tightened with a torque of 110 lb-ft (150 Nm).

Use only genuine Mercedes-Benz wheel bolts specified for your vehicle's rims.

For information on wheel change, see the "Practical hints" section (▷ page 344) and (▷ page 361).

## Operation

### Winter driving

#### ▼ Winter driving

Before the onset of winter, have your vehicle winterized at an authorized Mercedes-Benz Center. This service includes:

- Check of anticorrosion and antifreeze concentration.
- Addition of cleaning concentrate to the water of the windshield and headlamp cleaning system. Add MB Concentrate "S" to a premixed windshield washer solvent / antifreeze which is formulated for temperatures below freezing point (▷ page 396).
- Battery test. Battery capacity drops with decreasing ambient temperature. A well charged battery helps to ensure that the engine can be started even at low ambient temperatures.
- Tire change. Mercedes-Benz recommends M+S rated radial-ply tires with a minimum tread depth of approximately  $\frac{1}{8}$  in (4 mm) on all four wheels for the winter season.

#### Winter tires

Always use winter tires at temperatures below 45°F (7°C) and whenever wintry road conditions prevail. Use of winter tires is the only way to achieve the maximum effectiveness of the ABS, ESP, and 4MATIC in winter operation.

For safe handling, make sure that all mounted winter tires are of the same make and have the same tread design.

#### Warning!



Winter tires with a tread depth of less than  $\frac{1}{8}$  in (4 mm) must be replaced. They are no longer suitable for winter operation.

Always observe the speed rating of the winter tires installed on your vehicle. If the maximum speed for which your tires are rated is below the speed rating of your vehicle, you must place a notice to this effect where it will be seen by the driver. Such notices are available at your tire dealer or any authorized Mercedes-Benz Center.

#### Warning!



If you use your spare tire when winter tires are fitted on the other wheels, be aware that the difference in tire characteristics may very well impair turning stability and that overall driving stability may be reduced. Adapt your driving style accordingly.

Have the spare tire replaced with a winter tire at the nearest authorized Mercedes-Benz Center.

#### Block heater (Canada only)

The engine is equipped with a block heater.

The electrical cable may be installed at an authorized Mercedes-Benz Center.

#### Snow chains



When using snow chains, vehicles with AIRMATIC should only be driven at raised vehicle level (▷ page 219). Vehicles with ABC\* should only be driven at vehicle height 1 (▷ page 221).

Snow chains should only be driven on snow-covered roads at speeds not to exceed 30 mph (50 km/h). Remove chains as soon as possible when driving on roads without snow.



When driving with snow chains, you may wish to deactivate the ESP (▷ page 80) before setting the vehicle in motion. This will improve the vehicle's traction.

Please observe the following guidelines when using snow chains:

- Use of snow chains is not permissible with all wheel/tire combinations.
- Snow chains should only be used on the rear wheels. Follow the manufacturer's mounting instructions.
- Only use snow chains that are approved by Mercedes-Benz. Your authorized Mercedes-Benz Center will be glad to advise you on this subject.
- Use of snow chains may be prohibited depending on location. Always check local and state laws before installing snow chains.



Even on vehicles with all-wheel drive, use snow chains on rear tires only.

Do not use snow chains with tire sizes 245/45 R 18 on 8 1/2 x 18 rims and 265/40 R 18 in general (▷ page 384).

Do not use snow chains on tires mounted on AMG rims.

## Operation

### Maintenance

#### ▼ Maintenance

We strongly recommend that you have your vehicle serviced by an authorized Mercedes-Benz Center, in accordance with the Service Booklet at the times called for by the FSS (Flexible Service System).

Failure to have the vehicle maintained in accordance with the Service Booklet at the designated times/mileage called for by the FSS may result in vehicle damage not covered by the Mercedes-Benz Limited Warranty.



FSS will notify you when your next service is due.

Approximately one month before your next service is due, one of the following messages will appear in the multifunction display while you are driving or when you switch on the ignition (example service A):

SERVICE A IN XXXXX MILES (KM)  
SERVICE A IN XXX DAYS  
SERVICE A IN X DAY  
SERVICE A DUE NOW!



The type of service due is indicated in the multifunction display:

-  Minor service (A)
-  Major service (B)



The interval between services depends on your driving habits. A gentle driving style, moderate engine speeds and the avoidance of short-distance trips will lengthen the interval between services.

#### Clearing the service indicator

The service indicator is automatically cleared after 30 seconds. You can also clear it yourself.

- ▶ Press the reset button on the instrument cluster (▷ page 22).

#### Service term exceeded





If you have exceeded the suggested service term, you will see the following message in the multifunction display:

SERVICE A EXCEEDED BY XXXX MILES (KM)  
SERVICE A EXCEEDED BY XXX DAYS  
SERVICE A EXCEEDED BY X DAY

An acoustic signal will also sound.

The Mercedes-Benz Center will reset the service indicator following a completed service.

### Calling up the service indicator





- ▶ Switch on ignition.  
The standard display of the control system appears (▷ page 139).
- ▶ Press button  or  on the multifunction steering wheel until FSS indicator with the service symbol  or  and the service deadline appears in the multifunction display.



If the battery is disconnected, the days of disconnection will not be included in the count shown by the service indicator. To arrive at the true service deadline, you will need to subtract these days from the days shown in the service indicator.

Do not confuse the service indicator with the engine oil level indicator .

### Resetting the service indicator

- In the event that the service on your vehicle is not carried out by an authorized Mercedes-Benz Center, you can reset the service indicator yourself.
- ▶ Switch on ignition.  
The standard display of the control system appears (▷ page 139).
  - ▶ Press button  or  on the multifunction steering wheel until the FSS indicator with the service symbol  or  and the service deadline appears in the multifunction display.
  - ▶ Press reset button on the instrument cluster for about three seconds.

This message appears in the multifunction display:

SERVICE INTERVAL...  
RESET WITH  
R BUTTON FOR 3 SEC.

- ▶ To confirm, press reset button until you hear a signal.

The service indicator now displays the reset interval.



If the service indicator was inadvertently reset, have a Mercedes-Benz Center correct it.

Only reset if the proper service has been performed. Resetting the system without performing proper service as called for by the FSS will cause the FSS to incorrectly determine the next service interval which will result in engine damage not covered by the Mercedes-Benz Limited Warranty.



## Operation

### Vehicle care

#### ▼ Vehicle care

##### Cleaning and care of vehicle

###### Warning!



Many cleaning products can be hazardous. Some are poisonous, others are flammable. Always follow the instructions on the particular container. Always open your vehicle's doors or windows when cleaning the inside.

Never use fluids or solvents that are not designed for cleaning your vehicle.

In operation, even while parked, your vehicle is subjected to varying external influences which, if gone unchecked, can attack the paintwork as well as the underbody and cause lasting damage.

Such damage is caused not only by extreme and varying climatic conditions, but also by:

- Air pollution
- Road salt
- Tar
- Gravel and stone chipping

To avoid paint damage, you should immediately remove:

- Grease and oil
- Fuel
- Coolant
- Brake fluid
- Bird droppings
- Insects
- Tree resins, etc.

Frequent washing reduces and / or eliminates the aggressiveness and potency of the above adverse influences.

More frequent washings are necessary to deal with unfavorable conditions:

- near the ocean
- in industrial areas (smoke, exhaust emissions)
- during winter operation

You should check your vehicle from time to time for stone chipping or other damage. Any damage should be repaired as soon as possible to prevent corrosion.

In doing so, do not neglect the underbody of the vehicle. A prerequisite for a thorough check is a washing of the underbody followed by a thorough inspection. Damaged areas need to be re-undercoated.

Your vehicle has been treated at the factory with a wax-base rustproofing in the body cavities which will last for the lifetime of the vehicle. Post-production treatment is neither necessary nor recommended by Mercedes-Benz because of the possibility of incompatibility between materials used in the production process and others applied later.

We have selected car-care products and compiled recommendations which are specially matched to our vehicles and which always reflect the latest technology. You can obtain Mercedes-Benz approved car-care products at an authorized Mercedes-Benz Center.

Scratches, corrosive deposits, corrosion or damage due to negligent or incorrect care cannot always be removed or repaired with the car-care products recommended here. In such cases it is best to seek aid at an authorized Mercedes-Benz Center.

The following topics deal with the cleaning and care of your vehicle and give important “how-to” information as well as references to Mercedes-Benz approved car-care products.

Additional information can be found in the booklet “Vehicle Care Guide”.

### Power washer

When using a power washer for cleaning the vehicle, always observe the manufacturer’s operating instructions.



Vehicles with KEYLESS-GO\*:

If a door handle is hit by a strong jet of water, and a SmartKey with KEYLESS-GO\* is in close proximity, i.e. within approx. 3 ft. (approx. 1 m), the vehicle could be inadvertently locked or unlocked.



Never use a round nozzle to power-wash tires. The intense jet of water can result in damage to the tire.

Always replace a damaged tire.

Always keep the jet of water moving across the surface. Do not aim directly at electrical parts, electrical connectors, seals, or other rubber parts.

### Tar stains

Quickly remove tar stains before they dry and become more difficult to remove. A tar remover is recommended.

### Paintwork, painted body components

Mercedes-Benz approved Paint Care should be applied when water drops on the paint surface do not “bead up”, normally every three to five months, depending on climate and washing detergent used.

Mercedes-Benz approved Paint Cleaner should be applied if the paint surface shows signs of embedded dirt (i.e. loss of gloss).

Do not apply any of these products or wax if your vehicle is parked in the sun or if the hood is still hot.

Use the appropriate MB-Touch-Up Stick for quick and provisional repairs of minor paint damage (i.e. chips from stones, vehicle doors, etc.).

## Operation

### Vehicle care

#### Engine cleaning

Prior to cleaning the engine compartment make sure to protect electrical components and connectors from the intrusion of water and cleaning agents.

Corrosion protection, such as MB Anticorrosion Wax should be applied to the engine compartment after every engine cleaning. Before applying, all control linkage bushings and joints should be lubricated. The poly-V-belt and all pulleys should be protected from any wax.

#### Vehicle washing

Do not use hot water or wash your vehicle in direct sunlight. Only use a mild car wash detergent, such as Mercedes-Benz approved Car Shampoo.

Thoroughly spray the vehicle with a diffused jet of water. Direct only a very weak spray towards the ventilation intake. Use plenty of water and rinse the sponge and chamois frequently.

Rinse with clear water and thoroughly dry with a chamois. Do not allow cleaning agents to dry on the finish.

Due to the width of the vehicle, fold in exterior rear view mirrors prior to running the vehicle through an automatic car wash to prevent damage to the mirrors.

In the winter, thoroughly remove all traces of road salt as soon as possible.

When washing the underbody, do not forget to clean the inner sides of the wheels.



Vehicles with KEYLESS-GO\*:  
If a door handle is hit by a strong jet of water, and a SmartKey with KEYLESS-GO\* is in close proximity, i.e. within approx. 3 ft. (approx. 1 m), the vehicle could be inadvertently locked or unlocked.

#### Ornamental moldings

For regular cleaning and care of very dirty chrome-plated parts, use a chrome cleaner.

#### Headlamps, tail lamps, side markers, turn signal lenses

- ▶ Use a mild car wash detergent, such as Mercedes-Benz approved Car Shampoo, with plenty of water.

To prevent scratches, never apply strong force and use only a soft, non-scratchy cloth when cleaning the lenses. Do not attempt to wipe dirty lenses with a dry cloth or sponge.

#### Cleaning the DISTRONIC\* system sensor cover



#### ① DISTRONIC\* system sensor cover

- ▶ Use a mild car wash detergent, such as Mercedes-Benz approved Car Shampoo, with plenty of water to clean sensor cover ①.

To prevent scratches, never apply strong force and use only a soft, non-scratchy cloth when cleaning the sensor cover. Do not attempt to wipe dirty sensors with a dry cloth or sponge.

#### Cleaning the Parktronic\* system sensors

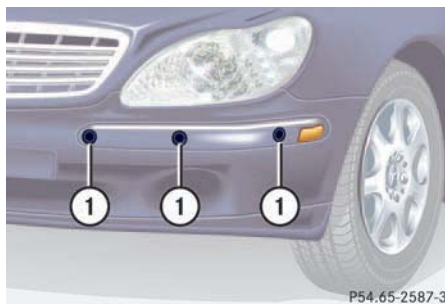

#### ① Parktronic\* sensors

- ▶ Use a mild car wash detergent, such as Mercedes-Benz approved Car Shampoo, with plenty of water to clean sensors ①.

When using a steam cleaner or power washer, aim nozzle only briefly from a minimum distance of 4 in (10 cm) at sensors ①.

To prevent scratches, never apply strong force and use only a soft, non-scratchy cloth when cleaning the sensor. Do not attempt to wipe dirty sensors with a dry cloth or sponge.

#### Wiper blades



Fold the windshield wiper arms away from the windshield to a vertical position only. They could otherwise damage the hood.

- ▶ Turn on the wipers and place it in a vertical position.

For information on placing the wipers to a vertical position, see “Replacing wiper blades” (▷ page 359).

## Operation

### Vehicle care

#### Warning!



For safety reasons, switch off wipers and remove SmartKey from starter switch before cleaning the wiper blades, otherwise the wiper motor might suddenly turn on and cause injury.

- ▶ Clean the wiper blade inserts with a clean cloth and detergent solution.



Fold the windshield wiper arms back onto the windshield before turning the SmartKey in the starter switch.

Hold on to the wiper when folding the wiper arm back. If released, the force of the impact from the tensioning spring could crack the windshield.

#### Window cleaning



Fold the windshield wiper arms away from the windshield in a vertical position only. They could otherwise damage the hood.

- ▶ Turn on the wipers and place it in a vertical position.

For information how to place the wipers in a vertical position, see “Replacing wiper blades” (▷ page 359).

#### Warning!



For safety reasons, switch off wipers and remove SmartKey from starter switch before cleaning the windshield, otherwise the wiper motor might suddenly turn on and cause injury.

- ▶ Use a window cleaning solution on all glass surfaces.

An automotive glass cleaner is recommended.



Fold the windshield wiper arms back onto the windshield before turning the SmartKey in the starter switch.

Hold on to the wiper when folding the wiper arm back. If released, the force of the impact from the tensioning spring could crack the windshield.

### Light alloy wheels

Mercedes-Benz approved Wheel Care should be used for regular cleaning of the light alloy wheels.

If possible, clean wheels once a week with Mercedes-Benz approved Wheel Care, using a soft bristle brush and a strong spray of water.

Follow the instructions on container.



Only use acid-free cleaning materials. Acid may cause corrosion or damage the clear coat.

### Instrument cluster

Use a gentle dishwashing detergent or mild detergent for delicate fabrics as a washing solution. Wipe with a cloth moistened in lukewarm solution. Do not use scouring agents.

### Steering wheel and gear selector lever

Wipe with a damp cloth and dry thoroughly or clean with Mercedes-Benz approved Leather Care.

### Cup holder

Use a gentle dishwashing detergent or mild detergent for delicate fabrics as a washing solution. Wipe with a cloth moistened in lukewarm solution. Do not use scouring agents.

### Hard plastic trim items

Pour Mercedes-Benz approved Interior Care onto soft lint-free cloth and apply with light pressure.

### Headliner and shelf below rear window

Clean with soft bristle brush, or use a dry-shampoo cleaner in case of excessive dirt.

### Seat belts

The webbing must not be treated with chemical cleaning agents. Only use clear, lukewarm water and soap. Do not dry the webbing at temperatures above 176°F (80°C) or in direct sunlight.

#### Warning!



Do not bleach or dye seat belts as this may severely weaken them. In a crash they may not be able to provide adequate protection.

## Operation

### Vehicle care

#### Upholstery

Using aftermarket seat covers or wearing clothing that have the tendency to give off coloring (e.g. when wet, etc.) may cause the upholstery to become permanently discolored. By lining the seats with a proper intermediate cover, contact-discoloration will be prevented.

#### Leather upholstery

Wipe leather upholstery with a damp cloth and dry thoroughly or clean with Mercedes-Benz approved Leather Care. Exercise particular care when cleaning perforated leather as its underside should not become wet.

#### Nubuck leather upholstery (S 55 AMG)

The nubuck leather upholstery is treated with a protective coating. Wipe nubuck leather upholstery with damp microfiber cloth to remove dust and other light stains. Carefully dab nubuck leather upholstery with a microfiber cloth to remove oil stains.



Do not use Mercedes-Benz approved Leather Care or any solvents to clean nubuck leather upholstery.

Avoid hard scrubbing on nubuck leather upholstery.

#### Plastic and rubber parts

Do not use oil or wax on these parts.

#### Wood trims

Dampen cloth using water and use damp cloth to clean wood trims in your vehicle. Do not use solvents like tar remover or wheel cleaner nor polishes or waxes as these may be abrasive.

## **Practical hints**

**What to do if ...?**

**Where will I find ...?**

**Unlocking/locking in an emergency**

**Opening/closing in an emergency**

**Replacing bulbs**

**Replacing wiper blades**

**Flat tire**

**Battery**

**Jump starting**

**Towing the vehicle**

**Fuses**





## Practical hints

### What to do if ...?

#### ▼ What to do if ...?

#### Lamps in instrument cluster

General information:

If a bulb in the instrument cluster fails to come on during the bulb self-check when

the ignition is turned on, have it checked and replaced if necessary.

| Problem                                                                                                                                             | Possible cause                                                                                                                                                                                                                                                                                                                                                                        | Suggested solution                                                                                                                                                                                                                                                                                                                       |
|-----------------------------------------------------------------------------------------------------------------------------------------------------|---------------------------------------------------------------------------------------------------------------------------------------------------------------------------------------------------------------------------------------------------------------------------------------------------------------------------------------------------------------------------------------|------------------------------------------------------------------------------------------------------------------------------------------------------------------------------------------------------------------------------------------------------------------------------------------------------------------------------------------|
|  The yellow ABS malfunction indicator lamp comes on while driving. | <p>The ABS has detected a malfunction and has switched off. The BAS and the ESP are also switched off (see messages in display).</p> <p>The brake system is still functioning normally but without the ABS available.</p> <p>If the ABS control unit is malfunctioning, other systems such as Parktronic*, Distronic*, and the automatic transmission may also be malfunctioning.</p> | <ul style="list-style-type: none"> <li>▶ Continue driving with added caution. Wheels may lock during hard braking, reducing steering capability.</li> <li>▶ Have the system checked at an authorized Mercedes-Benz Center as soon as possible.</li> </ul> <p>Failure to follow these instructions increases the risk of an accident.</p> |
|                                                                                                                                                     | <p>The charging voltage has fallen below 10 volts and the ABS has switched off.</p>                                                                                                                                                                                                                                                                                                   | <p>When the voltage is above this value again, the ABS is operational again.</p> <ul style="list-style-type: none"> <li>▶ If necessary, have the generator and battery checked.</li> </ul>                                                                                                                                               |

## Practical hints

### What to do if ...?

| Problem                                                                                                                          | Possible cause                                                                  | Suggested solution                                                                                                                                                                                         |
|----------------------------------------------------------------------------------------------------------------------------------|---------------------------------------------------------------------------------|------------------------------------------------------------------------------------------------------------------------------------------------------------------------------------------------------------|
| <b>BRAKE</b><br>(USA only)<br><br>(Canada only) | The red brake warning lamp comes on while driving and you hear a warning sound. | You are driving with the parking brake set. ▶ Release the parking brake (▷ page 45).                                                                                                                       |
|                                                                                                                                  | The red brake warning lamp comes on while driving.                              | There is insufficient brake fluid in the reservoir. ▶ Risk of accident! Carefully stop the vehicle and notify an authorized Mercedes-Benz Center. Do not add brake fluid! This will not solve the problem. |

### Warning!



Driving with the brake warning lamp illuminated can result in an accident. Have your brake system checked immediately if the brake warning lamp stays on. Do not add brake fluid before checking the brake system. Overfilling the brake fluid reservoir can result in spilling brake fluid on hot engine parts and the brake fluid catching fire. You can be seriously burned.



If you find that the brake fluid in the brake fluid reservoir has fallen to the minimum mark or below, have the brake system checked for brake pad thickness and leaks.



## Practical hints

### What to do if ...?

| Problem                                                                                                                                          | Possible cause                                                                                                                                                                                                                                                                                                                                                                                                                                 | Suggested solution                                                                                                                                                                                                                                                                                                                                                                                                    |
|--------------------------------------------------------------------------------------------------------------------------------------------------|------------------------------------------------------------------------------------------------------------------------------------------------------------------------------------------------------------------------------------------------------------------------------------------------------------------------------------------------------------------------------------------------------------------------------------------------|-----------------------------------------------------------------------------------------------------------------------------------------------------------------------------------------------------------------------------------------------------------------------------------------------------------------------------------------------------------------------------------------------------------------------|
| <p><b>CHECK ENGINE</b><br/>(USA only)</p>  <p>(Canada only)</p> | <p>The yellow malfunction indicator lamp comes on while driving.</p> <p>There is a malfunction in:</p> <ul style="list-style-type: none"> <li>• The fuel management system</li> <li>• The ignition system</li> <li>• The emission control system</li> <li>• Systems which affect emissions</li> </ul> <p>Such malfunctions may result in excessive emissions values and may switch the engine to its limp-home (emergency operation) mode.</p> | <p>► Have the vehicle checked as soon as possible by an authorized Mercedes-Benz Center. An on-board diagnostic connector is used by the service station to link the vehicle to the shop diagnostics system. It allows the accurate identification of system malfunctions through the read-out of diagnostic trouble codes. It is located in the front left area of the footwell next to the parking brake pedal.</p> |
|                                                                                                                                                  | <p>The fuel cap is not closed tightly.</p>                                                                                                                                                                                                                                                                                                                                                                                                     | <p>► Close the fuel cap.</p>                                                                                                                                                                                                                                                                                                                                                                                          |
|                                                                                                                                                  | <p>Your gas tank is empty.</p>                                                                                                                                                                                                                                                                                                                                                                                                                 | <p>► After refuelling, start the engine three or four times in succession.</p> <p>The limp-home mode is canceled. You do not need to have your vehicle checked.</p>                                                                                                                                                                                                                                                   |



## Practical hints

### What to do if ...?

| Problem                                                                                                                                                               | Possible cause                                                                                                                                                                                                         | Suggested solution                                                                                                                                                                                                                                                                                                                                                                                |
|-----------------------------------------------------------------------------------------------------------------------------------------------------------------------|------------------------------------------------------------------------------------------------------------------------------------------------------------------------------------------------------------------------|---------------------------------------------------------------------------------------------------------------------------------------------------------------------------------------------------------------------------------------------------------------------------------------------------------------------------------------------------------------------------------------------------|
|  The red Distronic warning lamp comes on while driving.                              | You are too close to the vehicle in front of you to maintain selected speed.                                                                                                                                           | ▶ Apply the brakes immediately to increase the following distance.                                                                                                                                                                                                                                                                                                                                |
|  The red Distronic warning lamp comes on while driving and you hear a warning sound. | <ul style="list-style-type: none"><li>• You are gaining too rapidly on the vehicle ahead of you.</li><li>• The distance warning system has recognized a stationary obstacle on your probable line of travel.</li></ul> | <ul style="list-style-type: none"><li>▶ Apply the brakes immediately.</li><li>▶ Carefully observe the traffic situation. You may need to brake or maneuver to avoid hitting an obstacle.</li></ul>                                                                                                                                                                                                |
|  The yellow ESP warning lamp flashes while driving.                                  | The ESP or traction control has come into operation because of detected traction loss in at least one tire.<br><br>Distronic* is deactivated.                                                                          | <ul style="list-style-type: none"><li>▶ When driving off, apply as little throttle as possible.</li><li>▶ While driving, ease up on the accelerator.</li><li>▶ Adapt your speed and driving to the prevailing road and weather conditions.</li><li>▶ Do not deactivate the ESP. Exceptions: (▷ page 80).</li></ul> <p>Failure to follow these instructions increases the risk of an accident.</p> |

## Practical hints

### What to do if ...?

| Problem                                                                                                                                                                | Possible cause                                                                                                                        | Suggested solution                                                                                                                                                 |
|------------------------------------------------------------------------------------------------------------------------------------------------------------------------|---------------------------------------------------------------------------------------------------------------------------------------|--------------------------------------------------------------------------------------------------------------------------------------------------------------------|
|  The yellow ESP warning lamp comes on while driving.                                  | The ESP is deactivated.<br>Risk of accident!<br>Adapt your speed and driving to the prevailing road, weather, and traffic conditions. | ► Switch the ESP back on (▷ page 81).<br>If the ESP cannot be switched back on, have the system checked at an authorized Mercedes-Benz Center as soon as possible. |
| The yellow fuel tank reserve warning lamp comes on while driving.                                                                                                      | The fuel level has gone below the reserve mark.                                                                                       | ► Refuel at the next gas station (▷ page 269).                                                                                                                     |
|  The red seat belt telltale illuminates for a brief period after starting the engine. | The warning lamp reminds you to fasten seat belts.                                                                                    | ► Fasten your seat belt.<br>The warning lamp goes out.                                                                                                             |

## Practical hints

### What to do if ...?

| Problem                                                                                                                                           | Possible cause                                                             | Suggested solution                                                                                                                                                                                                                          |
|---------------------------------------------------------------------------------------------------------------------------------------------------|----------------------------------------------------------------------------|---------------------------------------------------------------------------------------------------------------------------------------------------------------------------------------------------------------------------------------------|
|  The yellow warning lamp for the tire pressure monitor comes on. | The tire pressure monitor detects a loss of pressure in at least one tire. | <ul style="list-style-type: none"><li>▶ Bring the vehicle to a halt, avoiding abrupt steering and braking maneuvers. Observe the traffic situation around you.</li><li>▶ Take note of the messages in the multi-function display.</li></ul> |

### Warning!



When the tire pressure monitoring system warning lamp is lit, one or more of your tires is significantly under-inflated. You should stop and check your tires as soon as possible, and inflate them to the proper pressure as indicated on the vehicle's tire information placard. Driving on a significantly under-inflated tire causes the tire to overheat and can lead to tire failure.

Under-inflation also reduces fuel efficiency and tire tread life, and may affect the vehicle's handling and stopping ability. Each tire, including the spare, should be checked monthly when cold and set to the recommended inflation pressure as specified in the vehicle placard and owner's manual.



The recommended tire inflation pressures for your vehicle can be found on the inside of the fuel filler flap, not in the owner's manual.

## Practical hints

### What to do if ...?

| Problem                                                       | Possible cause                                                                                                                                                    | Suggested solution                                                         |
|---------------------------------------------------------------|-------------------------------------------------------------------------------------------------------------------------------------------------------------------|----------------------------------------------------------------------------|
| <b>SRS</b> The red SRS indicator lamp comes on while driving. | There is a malfunction in the restraint systems. The airbags or emergency tensioning devices (ETDs) could deploy unexpectedly or fail to activate in an accident. | ► Drive with added caution to the nearest authorized Mercedes-Benz Center. |

#### Warning!



In the event a malfunction of the SRS is indicated as outlined above, the SRS may not be operational. For your safety, we strongly recommend that you visit an authorized Mercedes-Benz Center immediately to have the system checked; otherwise the SRS may not be activated when needed in an accident, which could result in serious or fatal injury, or it might deploy unexpectedly and unnecessarily which could result in an accident and/or injury to you or to others.

**Lamp in center console**

| <b>Problem</b>                                                                                                                                     | <b>Possible cause</b>                                                                                                   | <b>Suggested solution</b>                                                                                                                                                                                                                                                                                                                                                     |
|----------------------------------------------------------------------------------------------------------------------------------------------------|-------------------------------------------------------------------------------------------------------------------------|-------------------------------------------------------------------------------------------------------------------------------------------------------------------------------------------------------------------------------------------------------------------------------------------------------------------------------------------------------------------------------|
| The PASSENGER AIRBAG OFF indicator lamp comes on.                                                                                                  | A BabySmart™ child seat is installed on the front passenger seat. Therefore the passenger front airbag is switched off. |                                                                                                                                                                                                                                                                                                                                                                               |
|                                                                                                                                                    | The system is malfunctioning when there is no BabySmart™ child seat installed on the front passenger seat.              | ▶ Have the system checked as soon as possible by an authorized Mercedes-Benz Center.                                                                                                                                                                                                                                                                                          |
| The PASSENGER AIRBAG OFF indicator lamp does not come on with a BabySmart™ <sup>1</sup> child seat properly installed on the front passenger seat. | The system is malfunctioning.                                                                                           | <p>▶ Make sure that there is nothing between seat cushion and child seat and check installation of the child seat.</p> <p>▶ If the light remains out, have the system checked as soon as possible by an authorized Mercedes-Benz Center.</p> <p>Do not use the BabySmart™ restraint to transport children on the front passenger seat until the system has been repaired.</p> |

<sup>1</sup> BabySmart™ is a trademark of Siemens AutomotiveCorp.



## Practical hints

### What to do if ...?

#### Messages in the display

The control system shows warning and malfunction messages in the multifunction display.

Certain warning and malfunction messages are accompanied by an audible signal.

Address these messages accordingly and follow the additional instructions given in this Operator's Manual.

Selecting the malfunction memory menu in the control system (▷ page 134) displays both cleared and uncleared messages.

High-priority messages appear in the multifunction display in red color.

Certain messages of high priority cannot be cleared from the multifunction display using the reset button (▷ page 22).

Other messages of high priority and messages of less immediate priority can be cleared from the multifunction display using the reset button (▷ page 22). These are then stored in the malfunction message memory (▷ page 150).

#### Warning!



All categories of messages contain important information which should be taken note of and, where a malfunction is indicated, addressed as soon as possible at an authorized Mercedes-Benz Center.

Failure to repair condition noted may cause damage not covered by the Mercedes-Benz Limited Warranty, or result in property damage or personal injury.

#### Warning!



No messages will be displayed if either the instrument cluster or the multifunction display is inoperative.

Contact your nearest authorized Mercedes-Benz Center.



Turning the SmartKey in the starter switch to position **2**, or pressing the KEYLESS-GO\* start/stop button twice causes all lamps as well as the multifunction display to come on. Make sure that they are all in working order before starting your journey.

On the pages that follow, you will find a compilation of the most important warning and malfunction messages that may appear in the display. High priority messages appear on a red background.

**Text messages**

| Display                | Display message                           | Possible cause                                                                                                                                                                                                                                                                                                                                                                                              | Possible solution                                                                                                                                                       |
|------------------------|-------------------------------------------|-------------------------------------------------------------------------------------------------------------------------------------------------------------------------------------------------------------------------------------------------------------------------------------------------------------------------------------------------------------------------------------------------------------|-------------------------------------------------------------------------------------------------------------------------------------------------------------------------|
| ABC                    | ACTIVE BODY CONTROL<br>DRIVE CAREFULLY!   | The capability of the ABC system is restricted. This can impair the handling.                                                                                                                                                                                                                                                                                                                               | <ul style="list-style-type: none"> <li>▶ Do not exceed a speed of 50 mph (80 km/h).</li> <li>▶ Visit an authorized Mercedes-Benz center as soon as possible.</li> </ul> |
|                        |                                           | The vehicle is losing oil.                                                                                                                                                                                                                                                                                                                                                                                  | <ul style="list-style-type: none"> <li>▶ Stop your vehicle as soon as it is safe to do so.</li> </ul>                                                                   |
|                        | ACTIVE BODY CONTROL<br>STOP, CAR TOO LOW! | The vehicle is parked on an extremely uneven surface.                                                                                                                                                                                                                                                                                                                                                       | <ul style="list-style-type: none"> <li>▶ Press the vehicle level control button to select level 2 (▷ page 221).</li> </ul>                                              |
| ABC is malfunctioning. |                                           | <ul style="list-style-type: none"> <li>▶ Stop and press the vehicle level control button to select a higher vehicle level (▷ page 221).</li> <li>▶ Do not turn steering wheel too far to avoid damaging the front fenders.</li> <li>▶ Listen for scraping noises.</li> <li>▶ Do not exceed a speed of 50 mph (80 km/h).</li> <li>▶ Visit an authorized Mercedes-Benz center as soon as possible.</li> </ul> |                                                                                                                                                                         |
|                        | DISPLAY MALFUNCTION<br>VISIT WORKSHOP!    | The display for ABC or the ABC system itself is malfunctioning.                                                                                                                                                                                                                                                                                                                                             | <ul style="list-style-type: none"> <li>▶ Visit an authorized Mercedes-Benz Center as soon as possible.</li> </ul>                                                       |

## Practical hints

### What to do if ...?

| Display    | Display message                        | Possible cause                                                                                                                                                                                 | Possible solution                                                                                                                                                                                                                                                                                                                        |
|------------|----------------------------------------|------------------------------------------------------------------------------------------------------------------------------------------------------------------------------------------------|------------------------------------------------------------------------------------------------------------------------------------------------------------------------------------------------------------------------------------------------------------------------------------------------------------------------------------------|
| ABC        | ACTIVE BODY CONTROL<br>VISIT WORKSHOP! | The capability of the ABC system is restricted.                                                                                                                                                | <ul style="list-style-type: none"> <li>▶ Do not exceed a speed of 50 mph (80 km/h).</li> <li>▶ Visit an authorized Mercedes-Benz center as soon as possible.</li> </ul>                                                                                                                                                                  |
| ABS        | MALFUNCTION!<br>VISIT WORKSHOP!        | <p>The ABS has detected a malfunction and has switched off. The ESP and the BAS are also deactivated.</p> <p>The brake system is still functioning normally but without the ABS available.</p> | <ul style="list-style-type: none"> <li>▶ Continue driving with added caution. Wheels may lock during hard braking, reducing steering capability.</li> <li>▶ Have the system checked at an authorized Mercedes-Benz Center as soon as possible.</li> </ul> <p>Failure to follow these instructions increases the risk of an accident.</p> |
|            | DISPLAY MALFUNCTION<br>VISIT WORKSHOP! | The ABS or the ABS display is malfunctioning.                                                                                                                                                  | <ul style="list-style-type: none"> <li>▶ Continue driving with added caution. Wheels may lock during hard braking, reducing steering capability.</li> <li>▶ Have the system checked at an authorized Mercedes-Benz Center as soon as possible.</li> </ul> <p>Failure to follow these instructions increases the risk of an accident.</p> |
| AIR FILTER | CHANGE CARTRIDGE<br>VISIT WORKSHOP!    | The air filter is clogged.                                                                                                                                                                     | <ul style="list-style-type: none"> <li>▶ Have the air filter checked by an authorized Mercedes-Benz Center.</li> </ul>                                                                                                                                                                                                                   |

## Practical hints

### What to do if ...?

| Display        | Display message                           | Possible cause                                                                            | Possible solution                                                                                                                                                                                             |
|----------------|-------------------------------------------|-------------------------------------------------------------------------------------------|---------------------------------------------------------------------------------------------------------------------------------------------------------------------------------------------------------------|
| CRUISE CONTROL | CRUISE CONTROL<br>VISIT WORKSHOP!         | Cruise control or Distronic* is malfunctioning.                                           | ▶ Have cruise control or Distronic* checked by an authorized Mercedes-Benz Center.                                                                                                                            |
| DISTRONIC      | EXTERNAL INTERFERENCE<br>REACTIVATE!      | Distronic* is switched off and is temporarily unavailable.                                | ▶ Try activating Distronic* again later.                                                                                                                                                                      |
|                | CURRENTLY UNAVAILABLE<br>SEE OPER. MANUAL | Distronic* is switched off because the Distronic* cover in the radiator grille is dirty.  | ▶ Clean the Distronic* cover in the radiator grille (> page 299).<br>▶ Restart the vehicle.                                                                                                                   |
|                | DRIVE TO WORKSHOP!                        | Distronic* is malfunctioning or the display is malfunctioning.                            | ▶ Visit an authorized Mercedes-Benz Center as soon as possible.                                                                                                                                               |
| ESP            | MALFUNCTION!<br>VISIT WORKSHOP!           | The ESP has detected a malfunction and switched off.<br>The ABS may still be operational. | ▶ Continue driving with added caution.<br>▶ Have the system checked at an authorized Mercedes-Benz Center as soon as possible.<br><br>Failure to follow these instructions increases the risk of an accident. |
|                | DISPLAY MALFUNCTION<br>VISIT WORKSHOP!    | The ESP or the ESP display is malfunctioning.                                             | ▶ Continue driving with added caution.<br>▶ Have the system checked at an authorized Mercedes-Benz Center as soon as possible.<br><br>Failure to follow these instructions increases the risk of an accident. |

## Practical hints

### What to do if ...?

| Display | Display message                    | Possible cause                                                                                      | Possible solution                                                                                                                                                                                                                                                                                                                                                                                                                                                                                                       |
|---------|------------------------------------|-----------------------------------------------------------------------------------------------------|-------------------------------------------------------------------------------------------------------------------------------------------------------------------------------------------------------------------------------------------------------------------------------------------------------------------------------------------------------------------------------------------------------------------------------------------------------------------------------------------------------------------------|
| ESP     | NOT AVAILABLE!<br>SEE OPER. MANUAL | The ESP was deactivated the power supply has been interrupted.<br><br>The ABS is still operational. | <ul style="list-style-type: none"><li>▶ Synchronize the ESP. With the vehicle stationary and the engine running, turn the steering wheel completely to the left and then to the right to synchronize the ESP.</li></ul> If the ESP message does not go out: <ul style="list-style-type: none"><li>▶ Continue driving with added caution.</li><li>▶ Have the system checked at an authorized Mercedes-Benz Center as soon as possible.</li></ul> Failure to follow these instructions increases the risk of an accident. |



When synchronizing the ESP, make sure you can turn the steering wheel in both directions as far as it will go without the wheel hitting any objects, e.g. a road curb.

## Practical hints

### What to do if ...?

| Display  | Display message               | Possible cause                                                                                                                                                                                                 | Possible solution                                               |
|----------|-------------------------------|----------------------------------------------------------------------------------------------------------------------------------------------------------------------------------------------------------------|-----------------------------------------------------------------|
| P        | SHIFT<br>TO P                 | You have tried to turn off the engine with the KEYLESS-GO* start/stop button with the gear selector lever not in <b>P</b> .                                                                                    | ▶ Place the gear selector lever in position <b>P</b> .          |
| PRE-SAFE | INACTIVE<br>SEE OPER. MANUAL! | If BAS or ESP malfunction messages are displayed simultaneously, PRE-SAFE has been deactivated as a result of these malfunctions. All other occupant safety systems, such as the airbags, are still available. | ▶ Visit an authorized Mercedes-Benz Center as soon as possible. |
|          |                               | PRE-SAFE itself has failed. All other occupant safety systems, such as the airbags, are still available.                                                                                                       | ▶ Visit an authorized Mercedes-Benz Center as soon as possible. |

## Practical hints

### What to do if ...?

#### Symbol messages

| Display symbol                                                                    | Display message                | Possible cause                                        | Possible solution                                                                                                                                                                                                                                                                                                                                                                                           |
|-----------------------------------------------------------------------------------|--------------------------------|-------------------------------------------------------|-------------------------------------------------------------------------------------------------------------------------------------------------------------------------------------------------------------------------------------------------------------------------------------------------------------------------------------------------------------------------------------------------------------|
|  | AIRMATIC<br>STOP, CAR TOO LOW! | The vehicle is parked on an extremely uneven surface. | <ul style="list-style-type: none"> <li>▶ Press the vehicle level control button to select the raised vehicle level (▷ page 219).</li> </ul>                                                                                                                                                                                                                                                                 |
|                                                                                   |                                | The vehicle level control is malfunctioning.          | <ul style="list-style-type: none"> <li>▶ Stop and press the vehicle level control button to select a higher vehicle level (▷ page 219).</li> <li>▶ Do not turn steering wheel too far to avoid damaging the front fenders.</li> <li>▶ Listen for scraping noises.</li> <li>▶ Do not exceed a speed of 50 mph (80 km/h).</li> <li>▶ Visit an authorized Mercedes-Benz center as soon as possible.</li> </ul> |
|                                                                                   | AIRMATIC<br>DRIVE CAREFULLY!   | The capability of the AIRMATIC system is restricted.  | <ul style="list-style-type: none"> <li>▶ Do not exceed a speed of 50 mph (80 km/h).</li> <li>▶ Visit an authorized Mercedes-Benz center as soon as possible.</li> </ul>                                                                                                                                                                                                                                     |

## Practical hints

### What to do if ...?

| Display symbol                                                                    | Display message                        | Possible cause                                                                                                                                                                                                                | Possible solution                                                                  |
|-----------------------------------------------------------------------------------|----------------------------------------|-------------------------------------------------------------------------------------------------------------------------------------------------------------------------------------------------------------------------------|------------------------------------------------------------------------------------|
|  | DISPLAY MALFUNCTION<br>VISIT WORKSHOP! | The display for AIRMATIC or the AIRMATIC system itself is malfunctioning.                                                                                                                                                     | ▶ Visit an authorized Mercedes-Benz Center as soon as possible.                    |
|                                                                                   | AIRMATIC<br>LEV. SEL. CANCELED!        | <ul style="list-style-type: none"><li>• You have exceeded a speed of 75 mph (120 km/h).</li><li>or</li><li>• You have maintained a speed of between 50 mph (80 km/h) and 75 mph (120 km/h) for more than 5 minutes.</li></ul> | ▶ Press the vehicle level control button to adjust the vehicle level (▷ page 219). |





## Practical hints

### What to do if ...?

| Display symbol                                                                    | Display message                       | Possible cause                                                                                                                                                                                                                                 | Possible solution                                                                                                                                                                                                                                                                                                                                                                                                                                                                                        |
|-----------------------------------------------------------------------------------|---------------------------------------|------------------------------------------------------------------------------------------------------------------------------------------------------------------------------------------------------------------------------------------------|----------------------------------------------------------------------------------------------------------------------------------------------------------------------------------------------------------------------------------------------------------------------------------------------------------------------------------------------------------------------------------------------------------------------------------------------------------------------------------------------------------|
|  | BATTERY/ALTERNATOR<br>VISIT WORKSHOP! | <p>The battery was charged with a battery charger or jump started.</p> <p>The battery is no longer charging.<br/>Possible causes:</p> <ul style="list-style-type: none"><li>• alternator malfunctioning</li><li>• broken poly-V-belt</li></ul> | <p>▶ Have the battery checked at a service station.</p> <p>▶ Stop immediately and check the poly-V-belt.</p> <p>If it is broken:</p> <p>▶ Do not continue to drive. Otherwise the engine will overheat due to an inoperative water pump which may result in damage to the engine. Notify an authorized Mercedes-Benz Center.</p> <p>If it is intact:</p> <p>▶ Drive immediately to the nearest authorized Mercedes-Benz Center. Adjust driving to be consistent with reduced braking responsiveness.</p> |

## Practical hints

### What to do if ...?

| Display symbol                                                                                                                   | Display message                   | Possible cause                                      | Possible solution                                                                                                                            |
|----------------------------------------------------------------------------------------------------------------------------------|-----------------------------------|-----------------------------------------------------|----------------------------------------------------------------------------------------------------------------------------------------------|
|                                                 | BRAKE PAD WEAR<br>VISIT WORKSHOP! | The brake pads have reached their wear limit.       | ► Have the brake pads replaced as soon as possible.                                                                                          |
| <b>BRAKE</b><br>(USA only)<br><br>(Canada only) | BRAKE FLUID<br>VISIT WORKSHOP!    | There is insufficient brake fluid in the reservoir. | ► Risk of accident! Stop the vehicle and notify an authorized Mercedes-Benz Center. Do not add brake fluid! This will not solve the problem. |
| <b>BRAKE</b><br>(USA only)<br><br>(Canada only) | PARK. BRAKE<br>RELEASE BRAKE!     | You are driving with the parking brake engaged.     | ► Release the parking brake (▷ page 45).                                                                                                     |

### Warning!



Driving with this message displayed can result in an accident. Have your brake system checked immediately. Don't add brake fluid before checking the brake system. Overfilling the brake fluid reservoir can result in spilling brake fluid on hot engine parts and the brake fluid catching fire. You can be seriously burned.





If you find that the brake fluid in the brake fluid reservoir has fallen to the minimum mark or below, have the brake system checked for brake pad thickness and leaks.



Brake pad thickness must be visually checked by a qualified technician at the intervals specified in the Service Booklet.

## Practical hints

### What to do if ...?

| Display symbol                                                                    | Display message         | Possible cause                                                                                                                                                                      | Possible solution                                                                                                                              |
|-----------------------------------------------------------------------------------|-------------------------|-------------------------------------------------------------------------------------------------------------------------------------------------------------------------------------|------------------------------------------------------------------------------------------------------------------------------------------------|
|  | VISIT WORKSHOP!         | There may be a malfunction in the: <ul style="list-style-type: none"><li>• Fuel injection system</li><li>• Ignition system</li><li>• Exhaust system</li><li>• Fuel system</li></ul> | ▶ Visit an authorized Mercedes-Benz Center as soon as possible.                                                                                |
|  | COOLANT<br>CHECK LEVEL! | The coolant level is too low.                                                                                                                                                       | ▶ Add coolant (▷ page 278).<br>▶ If you have to add coolant frequently, have the cooling system checked by an authorized Mercedes-Benz Center. |

#### Warning!



Do not spill antifreeze on hot engine parts. Antifreeze contains ethylene glycol which may burn if it comes into contact with hot engine parts. You can be seriously burned.



Do not ignore the low engine coolant level warning. Extended driving with the message and symbol displayed may cause serious engine damage not covered by the Mercedes-Benz Limited Warranty.

Do not drive without a sufficient amount of coolant in the cooling system. The engine will overheat, causing major engine damage.

## Practical hints

### What to do if ...?

| Display symbol                                                                    | Display message              | Possible cause          | Possible solution                                                                                                                                                                                      |
|-----------------------------------------------------------------------------------|------------------------------|-------------------------|--------------------------------------------------------------------------------------------------------------------------------------------------------------------------------------------------------|
|  | COOLANT<br>STOP, ENGINE OFF! | The coolant is too hot. | <ul style="list-style-type: none"><li>▶ Stop the vehicle and turn off the engine.</li><li>▶ Only start the engine again after the message disappears. You could otherwise damage the engine.</li></ul> |

### Warning!



Driving when your engine is badly overheated can cause some fluids which may have leaked into the engine compartment to catch fire. You could be seriously burned.

Steam from an overheated engine can cause serious burns and can occur just by opening the engine hood. Stay away from the engine if you see or hear steam coming from it.

Turn off the engine, get out of the vehicle and do not stand near the vehicle until the engine has cooled down.



During severe operating conditions, e.g. stop-and-go traffic, the coolant temperature may rise close to 248°F (120°C).



The engine should not be operated with the coolant temperature above 248°F (120°C). Doing so may cause serious engine damage which is not covered by the Mercedes-Benz Limited Warranty.



## Practical hints

### What to do if ...?

| Display symbol                                                                     | Display message              | Possible cause                                     | Possible solution                                                                                                                                                                                                                                                                                                                                                                                                                                                                                                                                                                                  |
|------------------------------------------------------------------------------------|------------------------------|----------------------------------------------------|----------------------------------------------------------------------------------------------------------------------------------------------------------------------------------------------------------------------------------------------------------------------------------------------------------------------------------------------------------------------------------------------------------------------------------------------------------------------------------------------------------------------------------------------------------------------------------------------------|
|   | COOLANT<br>STOP, ENGINE OFF! | The poly-V-belt could be broken.                   | <ul style="list-style-type: none"><li>▶ Stop immediately and check the poly-V-belt.</li></ul> If it is broken: <ul style="list-style-type: none"><li>▶ Do not continue to drive. Otherwise the engine will overheat due to an inoperative water pump which may result in damage to the engine. Notify an authorized Mercedes-Benz Center.</li></ul> If it is intact: <ul style="list-style-type: none"><li>▶ Do not continue to drive the vehicle with this message displayed. Doing so could result in serious engine damage that is not covered by the Mercedes-Benz Limited Warranty.</li></ul> |
|  | COOLANT<br>VISIT WORKSHOP!   | The cooling fan for the coolant is malfunctioning. | <ul style="list-style-type: none"><li>▶ Observe the coolant temperature display.</li><li>▶ Have the fan replaced as soon as possible.</li></ul>                                                                                                                                                                                                                                                                                                                                                                                                                                                    |

## Practical hints

### What to do if ...?

| Display symbol                                                                    | Display message                        | Possible cause                                                                                                                                                                                                                                               | Possible solution                                                                                                                                              |
|-----------------------------------------------------------------------------------|----------------------------------------|--------------------------------------------------------------------------------------------------------------------------------------------------------------------------------------------------------------------------------------------------------------|----------------------------------------------------------------------------------------------------------------------------------------------------------------|
|  | DISPLAY MALFUNCTION<br>VISIT WORKSHOP! | The instrument cluster display is malfunctioning.                                                                                                                                                                                                            | <ul style="list-style-type: none"><li>▶ Continue driving with added caution.</li><li>▶ Visit an authorized Mercedes-Benz Center as soon as possible.</li></ul> |
|  | DISPLAY MALFUNCTION<br>VISIT WORKSHOP! | Certain electronic systems are unable to relay information to the control system. The following systems may have failed: <ul style="list-style-type: none"><li>• Coolant temperature display</li><li>• Tachometer</li><li>• Cruise control display</li></ul> | <ul style="list-style-type: none"><li>▶ Have the electronic systems checked by an authorized Mercedes-Benz Center.</li></ul>                                   |
|  | DOOR OPEN!                             | You are attempting to drive with one or more doors open.                                                                                                                                                                                                     | <ul style="list-style-type: none"><li>▶ Close the doors.</li></ul>                                                                                             |

## Practical hints

### What to do if ...?

| Display symbol                                                                    | Display message                                                                                        | Possible cause                                                                                          | Possible solution                                                                                                                                                                                                                  |
|-----------------------------------------------------------------------------------|--------------------------------------------------------------------------------------------------------|---------------------------------------------------------------------------------------------------------|------------------------------------------------------------------------------------------------------------------------------------------------------------------------------------------------------------------------------------|
|  | USA only:<br>ADD 1.0 QT. ENGINE<br>OIL<br>AT NEXT REFUELING!                                           | The engine oil level is too low.                                                                        | ▶ Add engine oil (▷ page 277) and check the engine oil level (▷ page 274).                                                                                                                                                         |
|                                                                                   | Canada only:<br>ADD 1.0 LITER ENGINE<br>OIL<br>AT NEXT REFUELING!                                      |                                                                                                         |                                                                                                                                                                                                                                    |
|                                                                                   | ENGINE OIL LEVEL<br>STOP, ENGINE OFF!                                                                  | There is no oil in the engine. There is a danger of engine damage.                                      | <ul style="list-style-type: none"> <li>▶ Carefully bring the vehicle to a halt as soon as possible.</li> <li>▶ Turn off the engine.</li> <li>▶ Add engine oil (▷ page 277) and check the engine oil level (▷ page 274).</li> </ul> |
| ENGINE OIL LEVEL<br>REDUCE OIL LEVEL                                              | You have added too much engine oil. There is a risk of damaging the engine or the catalytic converter. | ▶ Have excess oil siphoned or drained off. Observe all legal requirements with respect to its disposal. |                                                                                                                                                                                                                                    |

## Practical hints

### What to do if ...?

| Display symbol                                                                    | Display message                      | Possible cause                                   | Possible solution                                                                                                                                                              |
|-----------------------------------------------------------------------------------|--------------------------------------|--------------------------------------------------|--------------------------------------------------------------------------------------------------------------------------------------------------------------------------------|
|  | ENGINE OIL<br>VISIT WORKSHOP!        | It may be that there is water in the engine oil. | ▶ Have the engine oil level checked (▷ page 274).                                                                                                                              |
|                                                                                   | ENGINE OIL LEVEL<br>VISIT WORKSHOP!  | The engine oil has dropped to a critical level.  | ▶ Check the engine oil level (▷ page 274) and add engine oil as required (▷ page 277).<br>▶ If you must add engine oil frequently, have the engine checked for possible leaks. |
|                                                                                   | ENGINE OIL SENSOR<br>VISIT WORKSHOP! | The measuring system is malfunctioning.          | ▶ Have the measuring system checked by an authorized Mercedes-Benz Center.                                                                                                     |

When the message ADD 1.0 QT. ENGINE OIL AT NEXT REFUELING! (Canada: 1 Liter) appears while the engine is running and at operating temperature, the engine oil level has dropped to approximately the minimum level.

When this occurs, the warning will first come on intermittently and then stay on if the oil level drops further.

Visually check for oil leaks. If no obvious oil leaks are noted, drive to the nearest service station where the engine oil should be topped to the required level with an approved oil.







The engine oil level warnings should not be ignored. Extended driving with the symbol displayed could result in serious engine damage that is not covered by the Mercedes-Benz Limited Warranty.





## Practical hints

### What to do if ...?

| Display symbol                                                                    | Display message                    | Possible cause                                                                                                                                                                                                                 | Possible solution                                                                                                                                                                                       |
|-----------------------------------------------------------------------------------|------------------------------------|--------------------------------------------------------------------------------------------------------------------------------------------------------------------------------------------------------------------------------|---------------------------------------------------------------------------------------------------------------------------------------------------------------------------------------------------------|
|  | ENTRY POSITION<br>DO NOT DRIVE!    | Seat, exterior mirrors and steering wheel have not yet moved to their preset driving positions.                                                                                                                                | ▶ Wait until the seat, exterior mirrors and steering wheel have moved to their driving positions.<br>The message will disappear.                                                                        |
|  | HOOD OPEN!                         | You are driving with the hood open.                                                                                                                                                                                            | ▶ Close the hood (▷ page 273).                                                                                                                                                                          |
|  | REMOVE KEY!                        | You have forgotten to remove the SmartKey.                                                                                                                                                                                     | ▶ Remove the SmartKey from the ignition.                                                                                                                                                                |
|                                                                                   | REPLACE KEY!<br>DRIVE TO WORKSHOP! | The batteries in the SmartKey are dead.                                                                                                                                                                                        | ▶ Change the batteries (▷ page 349).                                                                                                                                                                    |
|                                                                                   | AUTOM. LIGHT ON<br>REMOVE KEY!     |                                                                                                                                                                                                                                | ▶ Remove the SmartKey from the starter switch.                                                                                                                                                          |
|  | KEY<br>CHECK BATTERY!              | The battery in the KEYLESS-GO* key is discharged.                                                                                                                                                                              | ▶ Change the battery (▷ page 349).                                                                                                                                                                      |
|                                                                                   | KEY<br>NOT RECOGNIZED!             | SmartKey with KEYLESS-GO* is not recognized while the engine is running because <ul style="list-style-type: none"> <li>• the SmartKey is not in the vehicle</li> <li>• there is strong radio-frequency interference</li> </ul> | ▶ Stop the vehicle as soon as it is safe to do so.<br>▶ Search for the SmartKey.<br><br>Otherwise the vehicle cannot be centrally locked nor can the engine be started again after it has been stopped. |

## Practical hints

### What to do if ...?

| Display symbol                                                                    | Display message                                | Possible cause                                                                                             | Possible solution                                                                                                                                                                                             |
|-----------------------------------------------------------------------------------|------------------------------------------------|------------------------------------------------------------------------------------------------------------|---------------------------------------------------------------------------------------------------------------------------------------------------------------------------------------------------------------|
|  | KEY NOT RECOGNIZED!                            | The SmartKey with KEYLESS-GO* is momentarily not recognized.                                               | <ul style="list-style-type: none"> <li>▶ Change the position of the SmartKey with KEYLESS-GO* in the vehicle.</li> <li>▶ Operate the vehicle with the SmartKey in the starter switch if necessary.</li> </ul> |
|                                                                                   | KEY DETECTED IN VEHICLE                        | A SmartKey with KEYLESS-GO* left in the vehicle was recognized while locking the vehicle from the outside. | ▶ Take the SmartKey with KEYLESS-GO* out of the vehicle.                                                                                                                                                      |
|                                                                                   | KEY DRIVE TO WORKSHOP!                         | The KEYLESS-GO* system is malfunctioning.                                                                  | ▶ Visit an authorized Mercedes-Benz Center as soon as possible.                                                                                                                                               |
|  | 3RD BRAKE LIGHT CHECK LAMP!                    | The high mounted brake lamp is malfunctioning.                                                             | ▶ Visit an authorized Mercedes-Benz Center as soon as possible.                                                                                                                                               |
|                                                                                   | BRAKE LIGHT VISIT WORKSHOP!                    | Brake lamp illumination is delayed or lamp is permanently on.                                              | ▶ Visit an authorized Mercedes-Benz Center as soon as possible.                                                                                                                                               |
|                                                                                   | BRAKE LIGHT, L CHECK LAMP! SUBSTITUTE LAMP ON! | The left brake lamp is malfunctioning. A back-up bulb is being used.                                       | ▶ Visit an authorized Mercedes-Benz Center as soon as possible.                                                                                                                                               |
|                                                                                   | BRAKE LIGHT, R CHECK LAMP! SUBSTITUTE LAMP ON! | The right brake lamp is malfunctioning. A back-up bulb is being used.                                      | ▶ Visit an authorized Mercedes-Benz Center as soon as possible.                                                                                                                                               |
|                                                                                   | DISPLAY MALFUNCTION VISIT WORKSHOP!            | The display for the lamps or the system is malfunctioning.                                                 | ▶ Visit an authorized Mercedes-Benz Center as soon as possible.                                                                                                                                               |

## Practical hints

### What to do if ...?

| Display symbol                                                                    | Display message                                         | Possible cause                                                            | Possible solution                                               |
|-----------------------------------------------------------------------------------|---------------------------------------------------------|---------------------------------------------------------------------------|-----------------------------------------------------------------|
|  | FRONT FOGLAMP, L<br>CHECK LAMP!                         | The left front fog lamp is malfunctioning.                                | ► Visit an authorized Mercedes-Benz Center as soon as possible. |
|                                                                                   | FRONT FOGLAMP, R<br>CHECK LAMP!                         | The right front fog lamp is malfunctioning.                               | ► Visit an authorized Mercedes-Benz Center as soon as possible. |
|                                                                                   | FR. L. PARK. LAMP<br>CHECK LAMP!<br>SUBSTITUTE LAMP ON! | The left parking lamps are malfunctioning. A back-up bulb is being used.  | ► Replace the bulb as soon as possible.                         |
|                                                                                   | FR. R. PARK. LAMP<br>CHECK LAMP!<br>SUBSTITUTE LAMP ON! | The right parking lamps are malfunctioning. A back-up bulb is being used. | ► Replace the bulb as soon as possible.                         |
|                                                                                   | HIGH BEAM, L<br>CHECK LAMP!                             | The left high beam lamp is malfunctioning.                                | ► Replace the bulb as soon as possible.                         |
|                                                                                   | HIGH BEAM, R<br>CHECK LAMP!                             | The right high beam lamp is malfunctioning.                               | ► Replace the bulb as soon as possible.                         |
|                                                                                   | LICENSE PLATE LAMP, L<br>CHECK LAMP!                    | The left license plate lamp is malfunctioning.                            | ► Replace the bulb as soon as possible.                         |
|                                                                                   | LICENSE PLATE LAMP, R<br>CHECK LAMP!                    | The right license plate lamp is malfunctioning.                           | ► Replace the bulb as soon as possible.                         |

## Practical hints

### What to do if ...?

| Display symbol                                                                    | Display message                    | Possible cause                                                            | Possible solution                                                                                                                                                                                                                                             |
|-----------------------------------------------------------------------------------|------------------------------------|---------------------------------------------------------------------------|---------------------------------------------------------------------------------------------------------------------------------------------------------------------------------------------------------------------------------------------------------------|
|  | LIGHT SENSOR<br>DRIVE TO WORKSHOP! | The lamp sensor is malfunctioning. The headlamps switch on automatically. | <ul style="list-style-type: none"> <li>▶ In the control system, set lamp operation to manual (▷ page 154).</li> <li>▶ Switch on headlamps using the exterior lamp switch.</li> <li>▶ Visit an authorized Mercedes-Benz Center as soon as possible.</li> </ul> |
|                                                                                   | LOW BEAM, L<br>CHECK LAMP!         | The left low beam lamp is malfunctioning.                                 | ▶ Visit an authorized Mercedes-Benz Center as soon as possible.                                                                                                                                                                                               |
|                                                                                   | LOW BEAM, R<br>CHECK LAMP!         | The right low beam lamp is malfunctioning.                                | ▶ Visit an authorized Mercedes-Benz Center as soon as possible.                                                                                                                                                                                               |
|                                                                                   | MARKER LIGHT, FL<br>CHECK LAMP!    | The front left side marker lamp is malfunctioning.                        | ▶ Replace the bulb as soon as possible.                                                                                                                                                                                                                       |
|                                                                                   | MARKER LIGHT, FR<br>CHECK LAMP!    | The front right side marker lamp is malfunctioning.                       | ▶ Replace the bulb as soon as possible.                                                                                                                                                                                                                       |
|                                                                                   | REAR FOGLAMP<br>CHECK LAMP!        | The rear fog lamp is malfunctioning.                                      | ▶ Replace the bulb as soon as possible.                                                                                                                                                                                                                       |
|                                                                                   | REVERSE LIGHT, L<br>CHECK LAMP!    | The left reverse lamp is malfunctioning.                                  | ▶ Replace the bulb as soon as possible.                                                                                                                                                                                                                       |
|                                                                                   | REVERSE LIGHT, R<br>CHECK LAMP!    | The right reverse lamp is malfunctioning.                                 | ▶ Replace the bulb as soon as possible.                                                                                                                                                                                                                       |





## Practical hints

### What to do if ...?

| Display symbol                                                                    | Display message                                         | Possible cause                                                                            | Possible solution                       |
|-----------------------------------------------------------------------------------|---------------------------------------------------------|-------------------------------------------------------------------------------------------|-----------------------------------------|
|  | STANDING LIGHT, L<br>CHECK LAMP!<br>SUBSTITUTE LAMP ON! | The left standing lamp is malfunctioning. A back-up bulb is being used.                   | ▶ Replace the bulb as soon as possible. |
|                                                                                   | STANDING LIGHT, R<br>CHECK LAMP!<br>SUBSTITUTE LAMP ON! | The right standing signal lamp is malfunctioning. A back-up bulb is being used.           | ▶ Replace the bulb as soon as possible. |
|                                                                                   | TAIL LIGHT, L<br>CHECK LAMP!<br>SUBSTITUTE LAMP ON!     | The left tail lamp is malfunctioning. A back-up bulb is being used.                       | ▶ Replace the bulb as soon as possible. |
|                                                                                   | TAIL LIGHT, R<br>CHECK LAMP!<br>SUBSTITUTE LAMP ON!     | The right tail lamp is malfunctioning. A back-up bulb is being used.                      | ▶ Replace the bulb as soon as possible. |
|                                                                                   | SWITCH OFF LIGHTS!                                      | Lamps have been turned on although the SmartKey in the ignition is in position <b>0</b> . | ▶ Turn off the headlamps.               |
|                                                                                   | TURN SIGNAL F, L<br>CHECK LAMP!<br>SUBSTITUTE LAMP ON!  | The left front turn signal lamp is malfunctioning. A back-up bulb is being used.          | ▶ Replace the bulb as soon as possible. |
|                                                                                   | TURN SIGNAL F, R<br>CHECK LAMP!<br>SUBSTITUTE LAMP ON!  | The right front turn signal lamp is malfunctioning. A back-up bulb is being used.         | ▶ Replace the bulb as soon as possible. |







## Practical hints

### What to do if ...?

| Display symbol                                                                      | Display message                                      | Possible cause                                                                                                                               | Possible solution                                               |
|-------------------------------------------------------------------------------------|------------------------------------------------------|----------------------------------------------------------------------------------------------------------------------------------------------|-----------------------------------------------------------------|
|    | TURN SIGNAL, L<br>CHECK LAMP!<br>SUBSTITUTE LAMP ON! | The left rear turn signal lamp is malfunctioning. A back-up bulb is being used.                                                              | ► Replace the bulb as soon as possible.                         |
|                                                                                     | TURN SIGNAL, R<br>CHECK LAMP!<br>SUBSTITUTE LAMP ON! | The right rear turn signal lamp is malfunctioning. A back-up bulb is being used.                                                             | ► Replace the bulb as soon as possible.                         |
|                                                                                     | TURN SIG. MIRROR, L<br>CHECK LAMP!                   | The left turn signal in the side mirror is malfunctioning. This message will only appear if all light emitting diodes have stopped working.  | ► Visit an authorized Mercedes-Benz Center as soon as possible. |
|                                                                                     | TURN SIG. MIRROR, R<br>CHECK LAMP!                   | The right turn signal in the side mirror is malfunctioning. This message will only appear if all light emitting diodes have stopped working. | ► Visit an authorized Mercedes-Benz Center as soon as possible. |
|   | SEAT BELT SYSTEM<br>VISIT WORKSHOP!                  | The seat belt system is malfunctioning.                                                                                                      | ► Visit an authorized Mercedes-Benz Center as soon as possible. |
|  | CLOSE<br>SUNROOF!                                    | You have opened the driver's door with the SmartKey removed from the starter switch and the sliding/pop up roof open.                        | ► Close the sliding/pop-up roof (▷ page 199).                   |
|  | CLOSE<br>SUNROOF!                                    | You have opened the driver's door with the SmartKey removed from the starter switch and the sliding/pop up roof open.                        | ► Close the sliding/pop-up roof (▷ page 199).                   |

## Practical hints

### What to do if ...?

| Display symbol                                                                    | Display message                        | Possible cause                                                                                                                                                                                                                                                                                           | Possible solution                                                         |
|-----------------------------------------------------------------------------------|----------------------------------------|----------------------------------------------------------------------------------------------------------------------------------------------------------------------------------------------------------------------------------------------------------------------------------------------------------|---------------------------------------------------------------------------|
|  | TELE AID<br>DRIVE TO WORKSHOP!         | One or more main functions of the Tele Aid system are malfunctioning.                                                                                                                                                                                                                                    | ▶ Have the Tele Aid system checked by an authorized Mercedes-Benz Center. |
|                                                                                   | TELE AID BATTERY<br>DRIVE TO WORKSHOP! | The emergency power battery for the Tele Aid system is malfunctioning. If the vehicle battery is also discharged, Tele Aid will not be operational.                                                                                                                                                      | ▶ Have the Tele Aid system checked by an authorized Mercedes-Benz Center. |
|  | FUNCTION<br>NOT AVAILABLE!             | This display appears if button  or  on the multifunction steering wheel is pressed and the vehicle is not equipped with a telephone. |                                                                           |
|  | TRUNK OPEN!                            | This message will appear whenever the trunk lid is open.                                                                                                                                                                                                                                                 | ▶ Close the trunk lid.                                                    |
|  | WASHER FLUID<br>CHECK LEVEL!           | The fluid level has dropped to about $\frac{1}{3}$ of total reservoir capacity.                                                                                                                                                                                                                          | ▶ Add washer fluid (▷ page 281).                                          |

### Warning!



Do not spill antifreeze on hot engine parts. Antifreeze contains ethylene glycol which may burn if it comes into contact with hot engine parts. You could be seriously burned.

**Tire pressure monitor messages**  
(vehicles produced up to approximately  
October 2003)

| Display symbol                                                                    | Display message                                                                 | Possible cause                                                                                                                                                                                                                                                                                                                             | Possible solution                                      |
|-----------------------------------------------------------------------------------|---------------------------------------------------------------------------------|--------------------------------------------------------------------------------------------------------------------------------------------------------------------------------------------------------------------------------------------------------------------------------------------------------------------------------------------|--------------------------------------------------------|
|  | TIRE PRES.<br>DISPLAY AFTER DRIVING<br>A FEW MINS. REACTIVATE<br>USING R-BUTTON | The tire pressure is being checked.                                                                                                                                                                                                                                                                                                        |                                                        |
|                                                                                   | TIRE PRES. MONITOR<br>NOT ACTIVE                                                | The tire inflation pressure monitor* is unable to monitor the tire pressure due to <ul style="list-style-type: none"> <li>• the presence of several wheel sensors in the vehicle.</li> <li>• excessive wheel sensor temperatures.</li> <li>• a nearby radio interference source.</li> <li>• unrecognized wheel sensors mounted.</li> </ul> | ► Check the tire pressure at the next service station. |

**Warning!**



Do not drive with a flat tire. A flat tire affects the ability to steer or brake the vehicle.

You may lose control of the vehicle. Continued driving with a flat tire will cause excessive heat build-up and possibly a fire.



## Practical hints

### What to do if ...?

| Display symbol                                                                    | Display message                    | Possible cause                                                                                                               | Possible solution                                                                                                              |
|-----------------------------------------------------------------------------------|------------------------------------|------------------------------------------------------------------------------------------------------------------------------|--------------------------------------------------------------------------------------------------------------------------------|
|  | TIRE PRES. MONITOR REACTIVATE!     | The tire inflation pressure monitor* is deactivated.                                                                         | ▶ Activate the tire inflation pressure monitor* (▷ page 286).                                                                  |
|                                                                                   | TIRE PRES. MONITOR VISIT WORKSHOP! | The tire inflation pressure monitor* is malfunctioning.                                                                      | ▶ Have the tire inflation pressure monitor* checked by an authorized Mercedes-Benz Center.<br>▶ Change the wheel (▷ page 361). |
|                                                                                   |                                    | A wheel without proper sensor was installed.                                                                                 | ▶ Check and correct tire pressure as required (▷ page 283).                                                                    |
|                                                                                   | TIRE PRES. CAUTION, TIRE DEFECT!   | One or more tires are deflating.                                                                                             | ▶ Carefully bring the vehicle to a halt, avoiding abrupt steering and braking maneuvers.<br>▶ Change the wheel (▷ page 361).   |
|                                                                                   | TIRE PRES. CHECK TIRES!            | The tire pressure in one or more tires is already below the minimum value.<br>The tire pressure in one or more tires is low. | ▶ Carefully bring the vehicle to a halt, avoiding abrupt steering and braking maneuvers.<br>▶ Change the wheel (▷ page 361).   |

#### Warning!



Do not drive with a flat tire. A flat tire affects the ability to steer or brake the vehicle.

You may lose control of the vehicle. Continued driving with a flat tire will cause excessive heat build-up and possibly a fire.

## Practical hints

### What to do if ...?

| Display symbol                                                                    | Display message                         | Possible cause                        | Possible solution                                                                                                                                                                 |
|-----------------------------------------------------------------------------------|-----------------------------------------|---------------------------------------|-----------------------------------------------------------------------------------------------------------------------------------------------------------------------------------|
|  | TIRE PRES., RF<br>CAUTION, TIRE DEFECT! | The right front tire is deflating.    | <ul style="list-style-type: none"><li>▶ Carefully bring the vehicle to a halt, avoiding abrupt steering and braking maneuvers.</li><li>▶ Change the wheel (▷ page 361).</li></ul> |
|                                                                                   | TIRE PRES., RF<br>CHECK TIRES!          | The right front tire pressure is low. | <ul style="list-style-type: none"><li>▶ Carefully bring the vehicle to a halt.</li><li>▶ Check the tire pressure.</li><li>▶ Change the wheel (▷ page 361).</li></ul>              |
|                                                                                   | TIRE PRES., LF<br>CAUTION, TIRE DEFECT! | The left front tire is deflating.     | <ul style="list-style-type: none"><li>▶ Carefully bring the vehicle to a halt, avoiding abrupt steering and braking maneuvers.</li><li>▶ Change the wheel (▷ page 361).</li></ul> |
|                                                                                   | TIRE PRES., LF<br>CHECK TIRES!          | The left front tire pressure is low.  | <ul style="list-style-type: none"><li>▶ Carefully bring the vehicle to a halt.</li><li>▶ Check the tire pressure.</li><li>▶ Change the wheel (▷ page 361).</li></ul>              |

#### Warning!



Do not drive with a flat tire. A flat tire affects the ability to steer or brake the vehicle.

You may lose control of the vehicle. Continued driving with a flat tire will cause excessive heat build-up and possibly a fire.

## Practical hints

### What to do if ...?

| Display symbol                                                                    | Display message                         | Possible cause                       | Possible solution                                                                                                                                                                    |
|-----------------------------------------------------------------------------------|-----------------------------------------|--------------------------------------|--------------------------------------------------------------------------------------------------------------------------------------------------------------------------------------|
|  | TIRE PRES., RR<br>CAUTION, TIRE DEFECT! | The right rear tire is deflating.    | <ul style="list-style-type: none"> <li>▶ Carefully bring the vehicle to a halt, avoiding abrupt steering and braking maneuvers.</li> <li>▶ Change the wheel (▷ page 361).</li> </ul> |
|                                                                                   | TIRE PRES., RR<br>CHECK TIRES!          | The right rear tire pressure is low. | <ul style="list-style-type: none"> <li>▶ Carefully bring the vehicle to a halt.</li> <li>▶ Check the tire pressure.</li> <li>▶ Change the wheel (▷ page 361).</li> </ul>             |
|                                                                                   | TIRE PRES., LR<br>CAUTION, TIRE DEFECT! | The left rear tire is deflating.     | <ul style="list-style-type: none"> <li>▶ Carefully bring the vehicle to a halt, avoiding abrupt steering and braking maneuvers.</li> <li>▶ Change the wheel (▷ page 361).</li> </ul> |
|                                                                                   | TIRE PRES., LR<br>CHECK TIRES!          | The left rear tire pressure is low.  | <ul style="list-style-type: none"> <li>▶ Carefully bring the vehicle to a halt.</li> <li>▶ Check the tire pressure.</li> <li>▶ Change the wheel (▷ page 361).</li> </ul>             |

#### Warning!



Do not drive with a flat tire. A flat tire affects the ability to steer or brake the vehicle.

You may lose control of the vehicle. Continued driving with a flat tire will cause excessive heat build-up and possibly a fire.

**Tire pressure monitor messages**  
(vehicles produced as of approximately  
October 2003)

| Display symbol                                                                    | Display message                        | Possible cause                                              | Possible solution                                                                                                                                                                                                                        |
|-----------------------------------------------------------------------------------|----------------------------------------|-------------------------------------------------------------|------------------------------------------------------------------------------------------------------------------------------------------------------------------------------------------------------------------------------------------|
|  | TIRE PRES.<br>CAUTION, TIRE<br>DEFECT! | One or more tires are deflating.                            | <ul style="list-style-type: none"> <li>▶ Carefully bring the vehicle to a halt, avoiding abrupt steering and braking maneuvers. Observe the traffic situation around you</li> <li>▶ Repair or change the wheel (▷ page 361).</li> </ul>  |
|                                                                                   | TIRE PRES.<br>CHECK TIRES!             | The pressure has fallen significantly in one or more tires. | <ul style="list-style-type: none"> <li>▶ Carefully bring the vehicle to a halt, avoiding abrupt steering and braking maneuvers. Observe the traffic situation around you.</li> <li>▶ Repair or change the wheel (▷ page 361).</li> </ul> |
|                                                                                   | TIRE PRES.<br>PLEASE CORRECT!          | The pressure is too low in one or more tires.               | <ul style="list-style-type: none"> <li>▶ Check and correct tire pressure as required (▷ page 283).</li> </ul>                                                                                                                            |

**Warning!**



Do not drive with a flat tire. A flat tire affects the ability to steer or brake the vehicle.

You may lose control of the vehicle. Continued driving with a flat tire will cause excessive heat build-up and possibly a fire.

## Practical hints

### What to do if ...?

| Display symbol                                                                    | Display message                            | Possible cause                       | Possible solution                                                                                                                                                                                                 |
|-----------------------------------------------------------------------------------|--------------------------------------------|--------------------------------------|-------------------------------------------------------------------------------------------------------------------------------------------------------------------------------------------------------------------|
|  | TIRE PRES., LF<br>CAUTION, TIRE<br>DEFECT! | The left front tire is deflating.    | <ul style="list-style-type: none"> <li>▶ Bring the vehicle to a halt, avoiding abrupt braking maneuvers. Observe the traffic situation around you.</li> <li>▶ Repair or change the wheel (▷ page 361).</li> </ul> |
|                                                                                   | TIRE PRES., LF<br>CHECK TIRES!             | The left front tire pressure is low. | <ul style="list-style-type: none"> <li>▶ Bring the vehicle to a halt. Observe the traffic situation around you.</li> <li>▶ Check the tire.</li> <li>▶ Check and correct tire pressure as required.</li> </ul>     |
|                                                                                   | TIRE PRES., RF<br>CAUTION, TIRE<br>DEFECT! | The right front tire is deflating.   | <ul style="list-style-type: none"> <li>▶ Bring the vehicle to a halt, avoiding abrupt braking maneuvers. Observe the traffic situation around you.</li> <li>▶ Repair or change the wheel (▷ page 361).</li> </ul> |

#### Warning!



Do not drive with a flat tire. A flat tire affects the ability to steer or brake the vehicle.

You may lose control of the vehicle. Continued driving with a flat tire will cause excessive heat build-up and possibly a fire.

## Practical hints

### What to do if ...?

| Display symbol                                                                    | Display message                            | Possible cause                        | Possible solution                                                                                                                                                                                                    |
|-----------------------------------------------------------------------------------|--------------------------------------------|---------------------------------------|----------------------------------------------------------------------------------------------------------------------------------------------------------------------------------------------------------------------|
|  | TIRE PRES., RF<br>CHECK TIRES!             | The right front tire pressure is low. | <ul style="list-style-type: none"> <li>▶ Bring the vehicle to a halt. Observe the traffic situation around you.</li> <li>▶ Check the tire.</li> <li>▶ Check and correct tire pressure as required.</li> </ul>        |
|                                                                                   | TIRE PRES., LR<br>CAUTION, TIRE<br>DEFECT! | The left rear tire is deflating.      | <ul style="list-style-type: none"> <li>▶ Bring the vehicle to a halt, avoiding abrupt braking maneuvers. Observe the traffic situation around you.</li> <li>▶ Repair or change the wheel (&gt; page 361).</li> </ul> |
|                                                                                   | TIRE PRES., LR<br>CHECK TIRES!             | The left rear tire pressure is low.   | <ul style="list-style-type: none"> <li>▶ Bring the vehicle to a halt. Observe the traffic situation around you.</li> <li>▶ Check the tire.</li> <li>▶ Check and correct tire pressure as required.</li> </ul>        |

### Warning!



Do not drive with a flat tire. A flat tire affects the ability to steer or brake the vehicle.

You may lose control of the vehicle. Continued driving with a flat tire will cause excessive heat build-up and possibly a fire.

## Practical hints

### What to do if ...?

| Display symbol                                                                    | Display message                                              | Possible cause                                                                                                                                                                                      | Possible solution                                                                                                                                                                                                 |
|-----------------------------------------------------------------------------------|--------------------------------------------------------------|-----------------------------------------------------------------------------------------------------------------------------------------------------------------------------------------------------|-------------------------------------------------------------------------------------------------------------------------------------------------------------------------------------------------------------------|
|  | TIRE PRES., RR<br>CAUTION, TIRE<br>DEFECT!                   | The right rear tire is deflating.                                                                                                                                                                   | <ul style="list-style-type: none"> <li>▶ Bring the vehicle to a halt, avoiding abrupt braking maneuvers. Observe the traffic situation around you.</li> <li>▶ Repair or change the wheel (▷ page 361).</li> </ul> |
|                                                                                   | TIRE PRES., RR<br>CHECK TIRES!                               | The right rear tire pressure is low.                                                                                                                                                                | <ul style="list-style-type: none"> <li>▶ Bring the vehicle to a halt. Observe the traffic situation around you.</li> <li>▶ Check the tire.</li> <li>▶ Check and correct tire pressure as required.</li> </ul>     |
|                                                                                   | TIRE PRES. MONITOR<br>REACTIVE AFTER<br>CORRECTING PRESSURE! | <p>There was a tire pressure warning message.</p> <p>The yellow warning lamp for the tire pressure monitor comes on and you have not reactivated the system since the last tire pressure check.</p> | <ul style="list-style-type: none"> <li>▶ Activate the tire pressure monitor after correcting the tire pressure values (▷ page 283).</li> </ul>                                                                    |

#### Warning!



Do not drive with a flat tire. A flat tire affects the ability to steer or brake the vehicle.

You may lose control of the vehicle. Continued driving with a flat tire will cause excessive heat build-up and possibly a fire.

## Practical hints

### What to do if ...?

| Display symbol                                                                    | Display message                                      | Possible cause                                                                                                                                                                                                                                                                                                                            | Possible solution                                                                                                                                                                                                                                                            |
|-----------------------------------------------------------------------------------|------------------------------------------------------|-------------------------------------------------------------------------------------------------------------------------------------------------------------------------------------------------------------------------------------------------------------------------------------------------------------------------------------------|------------------------------------------------------------------------------------------------------------------------------------------------------------------------------------------------------------------------------------------------------------------------------|
|  | TIRE PRES. MONITOR REACTIVATED                       | The tire pressure monitor is using the current pressure values as the basis for monitoring.                                                                                                                                                                                                                                               |                                                                                                                                                                                                                                                                              |
|                                                                                   | TIRE PRES. MONITOR CURRENTLY UNAVAILABLE             | The tire inflation pressure monitor* is unable to monitor the tire pressure due to: <ul style="list-style-type: none"> <li>• the presence of several wheel sensors in the vehicle</li> <li>• excessive wheel sensor temperatures</li> <li>• a nearby radio interference source</li> <li>• unrecognized wheel sensors installed</li> </ul> | <ul style="list-style-type: none"> <li>▶ Remove any extra wheel sensors from the vehicle</li> </ul> <p>As soon as the causes of the malfunction have been removed, the tire pressure monitor automatically becomes active again.</p>                                         |
|                                                                                   | TIRE PRES. MONITOR NOT OPERATIONAL DRIVE TO WORKSHOP | The tire pressure monitor or a wheel sensor is malfunctioning.                                                                                                                                                                                                                                                                            | <ul style="list-style-type: none"> <li>▶ Have the tire inflation pressure monitor checked by an authorized Mercedes-Benz Center.</li> </ul> <p>A wheel without proper sensor was installed.</p> <ul style="list-style-type: none"> <li>▶ Have the wheels checked.</li> </ul> |

### Warning!



Do not drive with a flat tire. A flat tire affects the ability to steer or brake the vehicle.

You may lose control of the vehicle. Continued driving with a flat tire will cause excessive heat build-up and possibly a fire.



## Practical hints

### Where will I find ...?

#### ▼ Where will I find ...?

##### First aid kit

The first aid kit is located in the storage compartments under the front passenger seat.

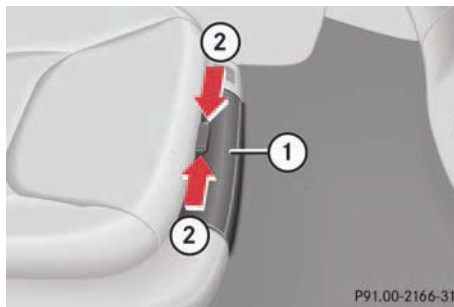

- ① Lid
- ② Buttons

##### Removing the first aid kit

- ▶ Press buttons ② together and fold lid ① down.  
Remove first aid kit.

##### Storing the first aid kit

- ▶ Place first aid kit in the storage compartments.
- ▶ Close lid ① until both buttons ② of lock engage.



Check expiration dates and contents for completeness at least once a year and replace missing/expired items.

##### Vehicle jack, vehicle tool kit, luggage bowl, spare wheel

The spare wheel, the vehicle tools, and the luggage bowl are stored in the compartment underneath the trunk floor.

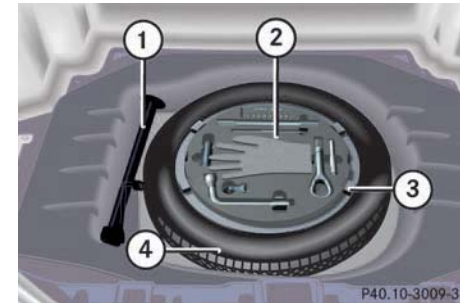

- ① Jack
- ② Storage tray with vehicle tool kit
- ③ Luggage bowl
- ④ Spare wheel

- ▶ Lift up trunk floor cover and engage trunk floor handle in upper edge of trunk.

You can now remove the tools and accessories.



To prevent damage, always disengage trunk floor handle from trunk lid and lower trunk floor before closing the trunk lid.

The vehicle tool kit includes:

- One interchangeable slot/Phillips screwdriver
- One towing eye bolt
- One wheel bolt wrench with socket wrench
- One alignment bolt
- One pair of gloves
- One fuse extractor
- One fuse chart for the main fuse box
- Spare fuses

### Vehicle jack

#### *To prepare the vehicle jack for use*

- ▶ Remove the vehicle jack from the spare wheel well under the trunk floor.
- ▶ Push the crank handle up.
- ▶ Turn the crank handle clockwise until it engages (operational position).



## Practical hints

### Where will I find ...?

#### *Storing the vehicle jack in the trunk*

- ▶ Retract the vehicle jack arm to the base of the vehicle jack.
- ▶ Push the crank handle up.
- ▶ Turn the crank handle counterclockwise to the end of the stop (storage position). ▷▷

## Practical hints

### Where will I find ...?



#### Warning!



The jack is designed exclusively for jacking up the vehicle at the jack take-up brackets built into both sides of the vehicle. To help avoid personal injury, use the jack only to lift the vehicle during a wheel change. Never get beneath the vehicle while it is supported by the jack. Keep hands and feet away from the area under the lifted vehicle. Always firmly set parking brake and block wheels before raising vehicle with jack.

Do not disengage parking brake while the vehicle is raised. Be certain that the jack is always vertical (plumb line) when in use, especially on hills. Always try to use the jack on level surface. Make sure the jack arm is fully seated in the jack take-up bracket. Always lower the vehicle onto sufficient capacity jackstands before working under the vehicle.

#### Spare wheel

##### Removing the spare wheel

- ▶ Take out the vehicle tool kit tray ②.
- ▶ Loosen the luggage bowl ③. To do so, turn the luggage bowl counterclockwise
- ▶ Remove the spare wheel ④.

##### Storing the spare wheel

- ▶ Place spare wheel ④ in wheel well.
- ▶ Secure the spare wheel. To do so, turn the luggage bowl ③ clockwise to its stop.
- ▶ Place vehicle tool kit tray ② in luggage bowl.

#### *Spare wheel S 430, S 500 and S 600 (except Sport Package \*)*

The spare wheel rim is mounted with a full sized tire of the same type as on the vehicle, and it is fully functional.

However, that spare wheel rim is weight optimized and has a limited service life of 12 000 miles (20 000 km) use before a standard wheel rim must replace it.

In case of flat tire, you may temporarily use the spare wheel.

Do not operate vehicle with more than one spare wheel mounted.

**Warning!**

Never operate the vehicle with more than one spare wheel mounted.

The spare wheel rim is for temporary use only. Use for over a total of 12 000 miles (20 000 km) (aggregate of all uses) may cause wheel rim failure leading to an accident and possible injuries.

The spare wheel should only be used temporarily and replaced with a regular road wheel as quickly as possible.

For more information, see “Rims and tires” (▷ page 384).

**Spare wheel S 55 AMG and Sport Package\***

In case of a flat tire, you may temporarily use the spare wheel when observing the following restrictions:

- Do not exceed a vehicle speed of 50 mph (80 km/h).
- Drive to the nearest tire repair facility to have the flat tire repaired or replaced as appropriate.
- Do not operate vehicle with more than one spare wheel mounted.

**Practical hints****Where will I find ...?****Warning!**

The dimensions of the spare wheel are different from those of the road wheels. As a result, the vehicle handling characteristics change when driving with a mounted spare wheel. Adapt your driving style accordingly.

Never operate the vehicle with more than one spare wheel mounted.

The spare wheel is for temporary use only. When driving with spare wheel mounted, ensure proper tire pressure and do not exceed vehicle speed of 50 mph (80 km).

The spare wheel rim is for temporary use only. Use for over a total of 12 000 miles (20 000 km) (aggregate of all uses) may cause wheel rim failure leading to an accident and possible injuries.

The spare wheel should only be used temporarily and replaced with a regular road wheel as quickly as possible.

For more information, see “Rims and tires” (▷ page 384).

## Practical hints

### Unlocking/locking in an emergency

#### ▼ Unlocking/locking in an emergency

##### Unlocking the vehicle



If you are unable to unlock the vehicle with the SmartKey, open the driver's door and the trunk using the mechanical key.



Unlocking your vehicle with the mechanical key will trigger the anti-theft alarm system.

To cancel the alarm, do one of the following:

With SmartKey

- Press button  or  on the SmartKey.
- Insert the SmartKey in the starter switch.

With KEYLESS-GO\*

- Press the KEYLESS-GO\* start/stop button (▷ page 33).
- Grasp the outside door handle (▷ page 55).



- ① Mechanical key locking tab
- ② Mechanical key

- ▶ Move locking tab ① in direction of arrow and slide the mechanical key ② out of the housing.

##### Unlocking the driver's door

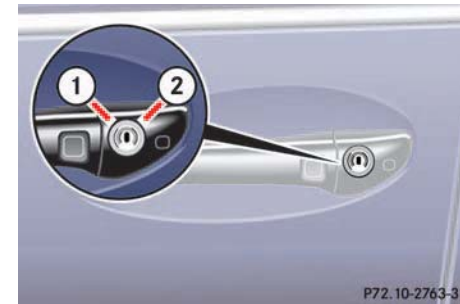

- ① Unlocking
- ② Locking

- ▶ Unlock the door with the mechanical key. To do so, push the mechanical key into the lock until it stops and turn it to the left.

Unlocking/locking in an emergency

**Unlocking the trunk**

A minimum height clearance of 6 ft. (1.85 m) is required to open the trunk lid.

If you are unable to unlock the trunk with the SmartKey or KEYLESS-GO\*, open the trunk with the mechanical key.

The trunk lid lock is located above the rear license plate recess.

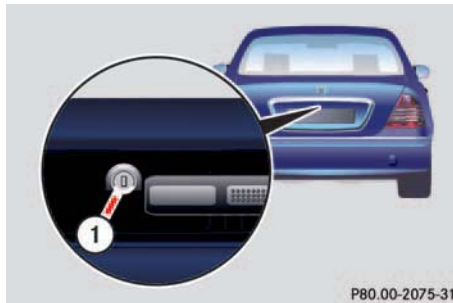

① Unlocking and opening

- ▶ Insert the mechanical key into the trunk lid lock.

- ▶ Turn the mechanical key counterclockwise to position ①.

The trunk unlocks and opens.



The trunk lid swings open upwards automatically. Always make sure that there is sufficient overhead clearance.

**Locking the vehicle**

If you are unable to lock the vehicle with the SmartKey or the SmartKey with KEYLESS-GO\*, lock it with the mechanical key as follows:

- ▶ Close the passenger doors and the trunk lid.
- ▶ Press the central locking switch in the center console (▷ page 107).
- ▶ Check to see whether the locking knob on the passenger door is still visible. If necessary push it down manually.

- ▶ Slide mechanical key ② out of the SmartKey (▷ page 348).

- ▶ Lock the driver's door with the mechanical key (▷ page 348).

- ▶ Lock the trunk lid if necessary with the mechanical key (if applicable) (▷ page 105).

**Replacing batteries in the SmartKey/SmartKey with KEYLESS-GO\***

If the batteries in the SmartKey or the SmartKey with KEYLESS-GO\* are discharged, the vehicle can no longer be locked or unlocked. It is recommended to have the batteries replaced at an authorized Mercedes-Benz Center.

**Warning!**



Keep the batteries out of reach of children. If a battery is swallowed, seek medical help immediately.

## Practical hints

### Unlocking/locking in an emergency

Batteries contain materials that can harm the environment if disposed of improperly. Recycling of batteries is the preferred method of disposal. Many states require sellers of batteries to accept old batteries for recycling.

#### SmartKey



- ① Mechanical key
- ② Battery compartment

Replacement batteries: Lithium, type CR 2025 or equivalent.



When changing batteries, always replace both batteries.

The required replacement batteries are available at any authorized Mercedes-Benz Center.

- ▶ Remove mechanical key ① (▷ page 348).
- ▶ Insert the mechanical key ① in side opening and push gray slide.  
The battery compartment is unlatched.
- ▶ Pull the battery compartment ② out of the SmartKey housing in direction of arrow.
- ▶ Remove the batteries.

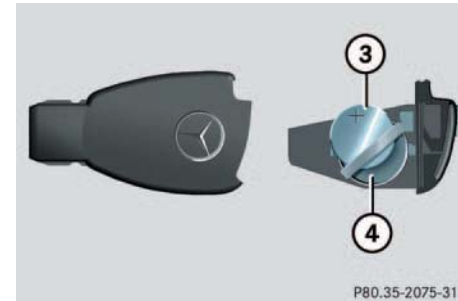

- ③ Battery
- ④ Contact spring

- ▶ Using a lint-free cloth, insert new batteries ③ under the contact spring ④ with the plus (+) side facing up.
- ▶ Return battery compartment into housing until it locks into place.

Unlocking/locking in an emergency

SmartKey with KEYLESS-GO\*

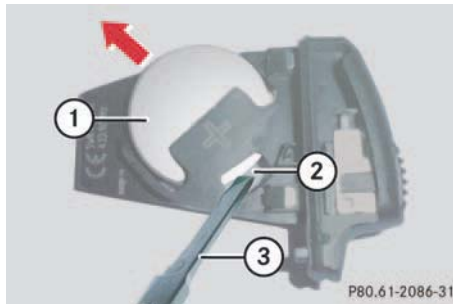

- ① Battery
- ② Tilt battery up
- ③ Mechanical key



The required replacement battery is available at any authorized Mercedes-Benz Center.

Replacement battery: Lithium, type CR 2025 or equivalent.

- ▶ Remove mechanical key (▷ page 348).
- ▶ Insert the mechanical key in side opening and push gray slide.

The battery compartment is unlatched.

- ▶ Pull the battery compartment out of the SmartKey housing.
- ▶ Using mechanical key ③, apply pressure to position ②.

Battery ① tilts up slightly.

- ▶ Pull out battery ① in direction of arrow.
- ▶ Using a lint-free cloth, insert new battery with the plus (+) side facing up.
- ▶ Return battery compartment into housing until it locks into place.

Fuel filler flap

In case the central locking system does not release the fuel filler flap, you can it manually.

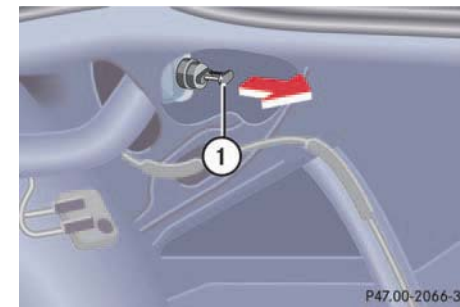

- ① Release knob

- ▶ Open the trunk.
- ▶ Remove the trim inside the trunk on the right-hand side.
- ▶ Pull release knob ① in the direction of arrow.

The fuel filler flap can be opened.



## Practical hints

### Opening/closing in an emergency

#### ▼ Opening/closing in an emergency

##### Sliding/pop-up roof

You can open or close the sliding/pop-up roof manually should an electrical malfunction occur.

The driving mechanism for the sliding/pop-up roof is located behind the lens of the interior overhead light.



① Lens

- ▶ Pry off lens ① using a flat blade screwdriver (▷ page 344).
- ▶ Turn the SmartKey in the starter switch to position **1** or **2**.
- ▶ Remove the crank from the operator's manual pouch.



② Crank

- ▶ Insert crank ② through hole.
- ▶ Turn crank ② clockwise to:
  - close slide roof
  - raise roof at the rear
- ▶ Turn crank ② counterclockwise to:
  - open slide roof
  - lower roof at the rear

The sliding/pop-up roof must be resynchronized after being operated manually (▷ page 202).

## Practical hints

### Replacing bulbs

#### ▼ Replacing bulbs

Safe vehicle operation depends on proper exterior lighting and signaling. It is therefore essential that all bulbs and lamp assemblies are in good working order at all times.

Correct headlamp adjustment is extremely important. Have headlamps checked and readjusted at regular intervals and when a bulb has been replaced. See an authorized Mercedes-Benz Center for headlamp adjustment.



Backup bulbs will be brought into use when the following lamps malfunction:

- Turn signal lamps
- Brake lamps
- Parking lamps
- Tail lamps

#### Bulbs

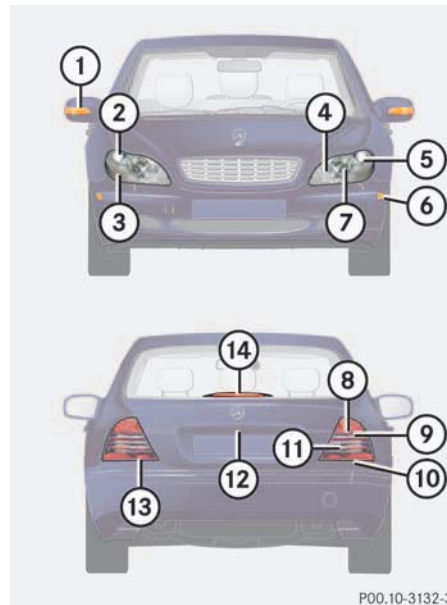

#### Front lamps

| Lamp                           | Type                             |
|--------------------------------|----------------------------------|
| ① Additional turn signal lamps | LED                              |
| ② Low beam <sup>1</sup>        | H7-55 W<br>Bi-Xenon*<br>D2S-35 W |
| ③ Turn signal lamp             | 2357 A                           |
| ④ Fog lamp                     | H7-55 W                          |
| ⑤ Parking and standing lamp    | W 5 W                            |
| ⑥ Side marker lamp             | W 5 W                            |
| ⑦ High beam                    | H7-55 W                          |

<sup>1</sup> Vehicles with Bi-Xenon headlamps\*: Low beam and high beam use the same D2S-35W lamp. Do not replace the Bi-Xenon bulbs yourself. See an authorized Mercedes-Benz Center.

## Practical hints

### Replacing bulbs

#### Rear lamps

|   | Lamp                                | Type     |
|---|-------------------------------------|----------|
| ⑧ | Brake lamp                          | LED      |
| ⑨ | Turn signal lamp                    | PY 21 W  |
| ⑩ | Tail and standing lamp, side marker | P 21/4 W |
| ⑪ | Backup lamp                         | P 21 W   |
| ⑫ | License plate lamps                 | C 5 W    |
| ⑬ | Tail lamp, Rear fog lamp            | P 21/4 W |
| ⑭ | High mounted brake lamp             | LED      |

#### Notes on bulb replacement

##### Warning!



Keep bulbs out of reach of children.

Bulbs and bulb sockets can be very hot. Allow the lamp to cool down before changing a bulb.

Halogen lamps contain pressurized gas. A bulb can explode if you:

- touch or move it when hot
- drop the bulb
- scratch the bulb

Wear eye and hand protection.

Because of high voltage in Bi-Xenon lamps, it is dangerous to replace the bulb or repair the lamp and its components. We recommend that you have such work done by a qualified technician.

- Only use 12 volt bulbs of the same type and with the specified watt rating.
- Switch lights off before changing a bulb to prevent short circuits.
- Always use a clean lint-free cloth when handling bulbs.
- Your hands should be dry and free of oil and grease.
- If the newly installed bulb does not come on, visit an authorized Mercedes-Benz Center.
- Have the LEDs and bulbs for the following lamps replaced by an authorized Mercedes-Benz Center.
  - Additional turn signal lamps in the exterior rear view mirrors
  - High mounted brake lamp
  - Bi-Xenon lamps\*
  - Front fog lamps

## Practical hints

### Replacing bulbs

#### Replacing bulbs for front lamps

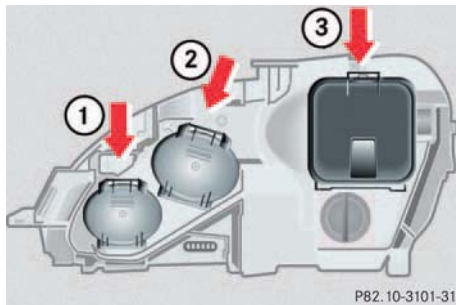

- ① Headlamp cover for fog lamp
- ② Headlamp cover for high beam halogen headlamp bulb, parking and standing lamp
- ③ Headlamp cover for Bi-Xenon\* (low and high beam) or halogen (low beam) headlamp bulb

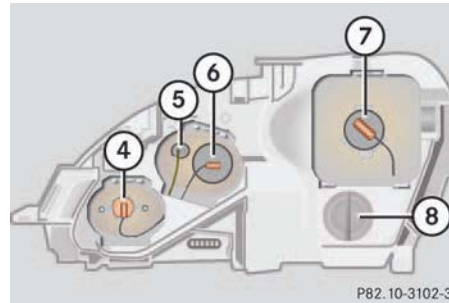

- ④ Bulb socket for fog lamp
- ⑤ Bulb socket for parking and standing lamp
- ⑥ Electrical connector for high beam halogen headlamp bulb
- ⑦ Electrical connector for low beam headlamp bulb
- ⑧ Bulb socket for turn signal lamp

#### Replacing low beam bulbs

##### *Bi-Xenon\* headlamp*

#### Warning!



Do not remove the cover for the Bi-Xenon headlamp. Because of high voltage in Xenon lamps, it is dangerous to replace the bulb or repair the lamp and its components. We recommend that you have such work done by a qualified technician.

##### *Halogen headlamp*

- ▶ Switch off the lights.
- ▶ Open the hood (▷ page 272).
- ▶ Press the tab on cover ③ and remove cover.
- ▶ Pull connector ⑦ off of the lamp.
- ▶ Release the retaining springs and take out the bulb.

▷▷

## Practical hints

### Replacing bulbs

- ▷▷▶ Insert the new bulb in the socket so that the base is in the recess on the lower left.
- ▶ Attach the retaining springs.
- ▶ Insert connector ⑦ into the bulb.
- ▶ Press cover ③ onto the housing until the tab engages.

### Replacing halogen high beam bulbs

- ▶ Switch off the lights.
- ▶ Open the hood (▷ page 272).
- ▶ Press the tab on cover ② and remove cover.
- ▶ Pull connector ⑥ off of the bulb.
- ▶ Apply pressure on the bulb contacts from above until the bulb releases from the retaining springs.
- ▶ Remove bulb.
- ▶ Insert the new bulb in the socket with the marking facing upward.
- ▶ Press the bulb upward on the contacts until it engages in the retaining springs.
- ▶ Insert connector ⑥ onto the bulb.
- ▶ Press cover ② onto the housing until the tab engages.

### Front turn signal lamp bulb

- ▶ Switch off the lights.
- ▶ Open the hood (▷ page 272).
- ▶ Twist bulb socket ⑧ counterclockwise and pull out.
- ▶ Gently push bulb into socket, turn counterclockwise and remove.
- ▶ Insert new bulb in socket, push in and twist clockwise.
- ▶ Reinstall bulb socket in lamp and twist clockwise until it engages.

### Parking and standing lamp bulb

- ▶ Switch off the lights.
- ▶ Open the hood (▷ page 272).
- ▶ Press the tab on cover ② and remove cover.
- ▶ Pull out the bulb socket ⑤ with the bulb.
- ▶ Pull the bulb out of the bulb socket.
- ▶ Insert a new bulb in the socket.
- ▶ Reinstall the bulb socket.
- ▶ Press cover ② onto the housing until the tab engages.

### Side marker lamp bulb

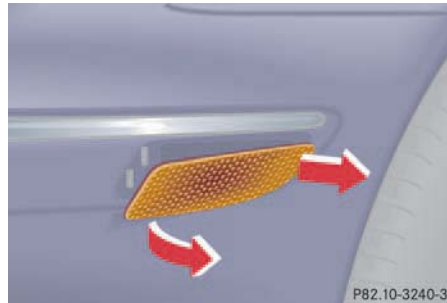

- ▶ Switch off the lights.
- ▶ Carefully slide lamp towards rear.
- ▶ Remove front end first.
- ▶ Twist bulb socket counterclockwise and pull out.

## Practical hints

### Replacing bulbs

- ▶ Pull bulb out of the bulb socket.
- ▶ Insert new bulb in socket.
- ▶ Reinstall bulb socket, push in and twist clockwise.
- ▶ To reinstall lamp, set rear end in bumper and let front end snap into place.

## Practical hints

### Replacing bulbs

#### Replacing bulbs for rear lamps

##### Tail lamp assemblies

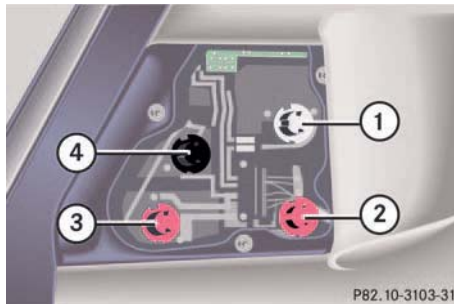

- ① Turn signal lamp (white socket)
- ② Tail, parking, standing, and side marker lamp (red socket)
- ③ Tail lamp, rear fog lamp (red socket)
- ④ Backup lamp (black socket)

- ▶ Switch off the lights.
- ▶ Open trunk.
- ▶ Turn the catch, and move the trim to the side.
- ▶ Turn bulb socket counterclockwise and pull out.
- ▶ Gently twist bulb counterclockwise and pull out of bulb holder.
- ▶ Insert new bulb into the holder and turn it clockwise.
- ▶ Reinstall bulb socket.
- ▶ The bulb socket should audibly click.
- ▶ Replace trim and secure with lock.

#### License plate lamp

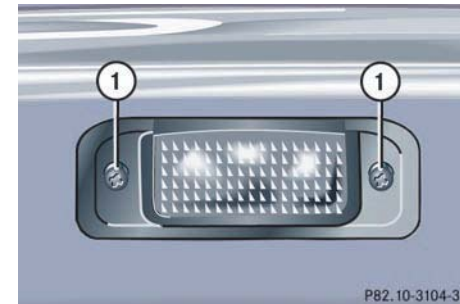

- ① Screws
- ▶ Switch off the lights.
- ▶ Loosen both screws ① and remove lamp.
- ▶ Replace the tubular lamp and reinstall it.
- ▶ Retighten the screws.

## ▼ Replacing wiper blades



To avoid damage to the hood, the wiper arms should only be folded forward when in the vertical position.

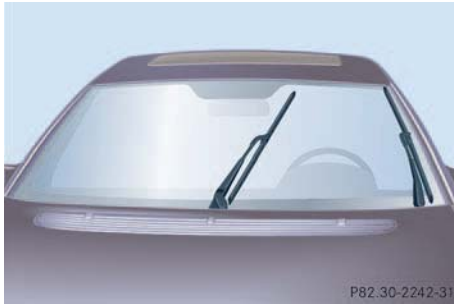

Wiper blades in vertical position

### Removing wiper blades

- ▶ Turn SmartKey in starter switch position **1**.
- ▶ Turn combination switch to wiper setting **II** (> page 48).
- ▶ With wiper arm in vertical position, turn SmartKey in starter switch to position **0**.

#### Warning!



For safety reasons, remove SmartKey from starter switch before replacing a wiper blade. Otherwise the motor could suddenly turn on and cause injury.

## Practical hints

### Replacing wiper blades

- ▶ Fold the wiper arm forward until it snaps into place.

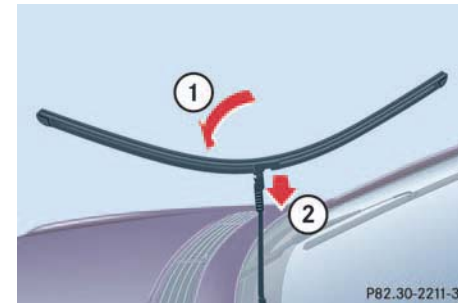

- ▶ Turn the wiper blade at a right angle to wiper arm (arrow ①).
- ▶ Slide the wiper blade sideways out of the retainer in the direction of arrow ②.



## Practical hints

### Replacing wiper blades

#### Installing wiper blades

- ▶ Slide the wiper blade onto wiper arm until it locks in place
- ▶ Rotate the wiper blade into position parallel to wiper arm.
- ▶ Fold the wiper arm backward to rest on the windshield. Make sure you hold onto the wiper when folding the wiper arm back.



Never open the hood when the wiper arm is folded forward.

Hold on to the wiper when folding the wiper arm back. If released, the force of the impact from the tensioning spring could crack the windshield.

Do not allow the wiper arms to contact the windshield glass without a wiper blade inserted.

Make certain that the wiper blades are properly installed. Improperly installed wiper blades may cause windshield damage.

For your convenience, we recommend that you have this work carried out by an authorized Mercedes-Benz Center.

## ▼ Flat tire

### Preparing the vehicle

- ▶ Park the vehicle as far as possible from moving traffic on a hard surface.
- ▶ Turn on the hazard warning flashers.
- ▶ Turn the steering wheel so that the front wheels are in a straight ahead position.
- ▶ Set the parking brake.
- ▶ Move the gear selector lever to **P**.

Vehicles with SmartKey:

- ▶ Turn off the engine (▷ page 53).
- ▶ Remove the SmartKey from the starter switch.

Vehicles with SmartKey with KEYLESS-GO\*:

- ▶ Turn off the engine by pressing the KEYLESS-GO\* button on the gear selector lever once (▷ page 54).
- ▶ Open the driver's door (this puts the starter switch in position **0**, same as with the SmartKey removed from the starter switch). The driver's door then can be closed again.



Open door only when conditions are safe to do so.

- ▶ Have any passenger exit the vehicle at a safe distance from the roadway.

## Practical hints

### Flat tire

### Mounting the spare wheel

#### Warning!



Never operate the vehicle with more than one spare wheel mounted.

The spare wheel rim is for temporary use only. Use for over a total of 12 000 miles (20 000 km) (aggregate of all uses) may cause wheel rim failure leading to an accident and possible injuries.

The spare wheel should only be used temporarily and replaced with a regular road wheel as quickly as possible.

S 55 AMG and Sport Package\* only:  
The spare wheel is for temporary use only. When driving with spare wheel mounted, ensure proper tire pressure and do not exceed vehicle speed of 50 mph (80 km/h). The dimensions of the spare wheel are different from those of the road wheels. As a result, the vehicle handling characteristics change when driving with a mounted spare wheel. Adapt your driving style accordingly.

## Practical hints

### Flat tire

#### Preparing the vehicle

- ▶ Take vehicle tool kit tray and vehicle jack out of trunk .
- ▶ Take the spare wheel out of wheel well (▷ page 344).

#### Lifting the vehicle

- ▶ Prevent the vehicle from rolling away by blocking wheels with wheel chocks (not included) or other sizable objects.

When changing wheel on a level surface:

- ▶ Place one chock in front of and one behind the wheel that is diagonally opposite to the wheel being changed.

When changing wheel on a hill:

- ▶ Place chocks behind the downhill sides of both wheels of the axle not being worked on.

#### Warning!



The jack is designed exclusively for jacking up the vehicle at the jack tubes built both sides of the vehicle. To help avoid personal injury, use the jack only to lift the vehicle during a wheel change. Never get beneath the vehicle while it is supported by the jack. Keep hands and feet away from the area under the lifted vehicle. Always firmly set parking brake and block wheels before raising vehicle with jack.

Do not disengage parking brake while the vehicle is raised. Be certain that the jack is always vertical (plumb line) when in use, especially on hills. Always try to use the jack on level surface. Make sure the jack arm is fully inserted in the jack tube. Always lower the vehicle onto sufficient capacity jack-stands before working under the vehicle.



- ▶ Take the two-piece wheel wrench out of the vehicle tool kit tray. Assemble wheel wrench.
- ▶ On wheel to be changed, loosen but do not yet remove the wheel bolts (approximately one full turn with wrench).

The tube openings are located directly behind the front wheel housings and in front of the rear wheel housings.

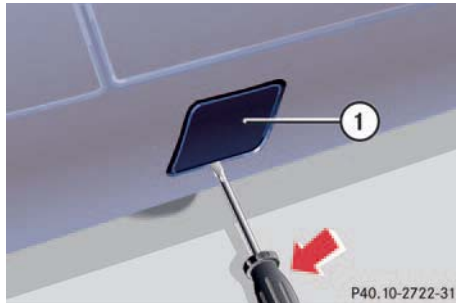

- ① Jack support tube cover
- ▶ Move cover ① toward rear by pressing at point indicated by arrow.
  - ▶ Remove cover ① carefully to avoid damage to the locking tabs.

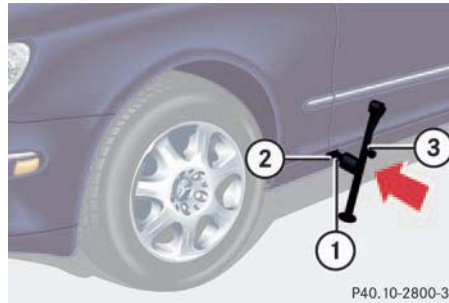

- ① Jack support tube hole  
② Jack arm  
③ Crank
- ▶ Insert jack arm ② fully into tube hole ① up to the stop.

**Warning!**



Insert the jack arm fully into the jack support tube hole up to the stop. Otherwise the vehicle may fall from the jack and cause personal injury or damage to the vehicle.

**Practical hints**

**Flat tire**

- ▶ Keeping jack in this position, turn crank ③ clockwise until the jack base meets the ground. Make sure the jack is vertical (plumb line).
- ▶ Continue to turn the crank until the tire is a maximum of 1.2 in (3 cm) from the ground.

**Warning!**



The jack is intended only for lifting the vehicle briefly for wheel changes. It is not suited for performing maintenance work under the vehicle.

- Never start the engine when the vehicle is raised.
- Never lie down under the raised vehicle.

## Practical hints

### Flat tire

#### Removing the wheel

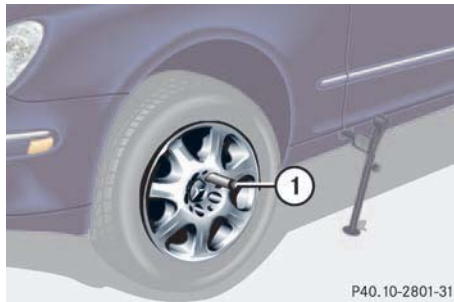

#### ① Alignment bolt

- ▶ Unscrew upper-most wheel bolt and remove.
- ▶ Replace this wheel bolt with alignment bolt ① supplied in the tool kit.
- ▶ Remove the remaining bolts.



Do not place wheel bolts in sand or dirt. This could result in damage to the bolt and wheel hub threads.

- ▶ Remove the wheel.

#### Mounting the new wheel

- ▶ Clean contact surfaces of wheel and wheel hub.



To avoid paint damage, place wheel flat against hub and hold it there while installing first wheel bolt.

#### Warning!



Always replace wheel bolts that are damaged or rusted.

Never apply oil or grease to wheel bolts.

Damaged wheel hub threads should be repaired immediately. Do not continue to drive under these circumstances! Contact an authorized Mercedes-Benz Center or call Roadside Assistance.

Incorrect wheel bolts or improperly tightened wheel bolts can cause the wheel to come off. This could cause an accident. Make sure you are using the correct wheel bolts.

- ▶ Guide the spare wheel onto the alignment bolt and push it on.
- ▶ Insert wheel bolts and tighten them slightly.
- ▶ Unscrew the alignment bolt, install last wheel bolt and tighten slightly.

#### Warning!



Use only genuine equipment Mercedes-Benz wheel bolts. Other wheel bolts may come loose.

Do not tighten the wheel bolts when the vehicle is raised. Otherwise the vehicle could tip over.

### Lowering the vehicle

- ▶ Lower vehicle by turning crank counterclockwise until vehicle is resting fully on its own weight.
- ▶ Remove the jack.

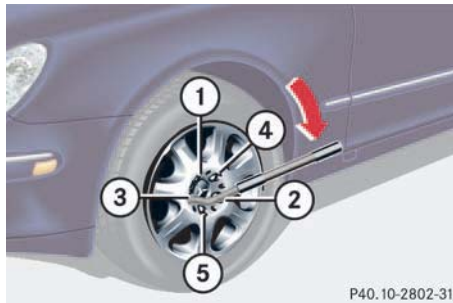

① - ⑤ Wheel bolts

- ▶ Tighten the five wheel bolts evenly, following the diagonal sequence illustrated (① to ⑤), until all bolts are tight. Observe a tightening torque of 110 lb-ft (150 Nm).

### Warning!



Have the tightening torque checked after changing a wheel. The wheels could come loose if they are not tightened to a torque of 110 lb-ft. (150 Nm).

- ▶ Before storing the jack in the trunk, it should be fully collapsed, with handle folded in.
- ▶ Place the wheel bolt wrench, alignment bolt and jack back in the vehicle tool kit in the trunk and close the covering lid.

## Practical hints

### Flat tire

#### Replacing jack support tube cover

- ▶ Slide tongue of cover under the upper edge of the tube opening.
- ▶ Applying even pressure, press cover until it snaps into place. Be careful not to damage the locking tabs or clamp the plastic retaining strap.



You can also screw the faulty wheel down into the spare wheel well in the trunk.

Do not activate the tire inflation pressure monitor\* until the depressurized tire is no longer in the vehicle.

## Practical hints

### Battery

#### ▼ Battery

##### Warning!



Failure to follow these instructions can result in severe injury or death.

Never lean over batteries while connecting, you might get injured.

Battery fluid contains sulfuric acid. Do not allow this fluid to come in contact with eyes, skin or clothing. In case it does, immediately flush affected area with water and seek medical help if necessary.

A battery will also produce hydrogen gas, which is flammable and explosive. Keep flames or sparks away from battery, avoid improper connection of jumper cables, smoking, etc.

##### Warning!



Do not place metal objects on the battery as this could result in a short circuit.

Use leak-proof battery only to avoid the risk of acid burns in the event of an accident.



Never loosen or detach battery terminal clamps while the engine is running or the SmartKey is in the starter switch. Otherwise the alternator and other electronic components could be severely damaged.

Have the battery checked regularly by an authorized Mercedes-Benz Center. Refer to Service Booklet for maintenance intervals or contact an authorized Mercedes-Benz Center for further information.

##### Warning!



With a disconnected battery

- you will no longer be able to turn the SmartKey in the starter switch and pressing the KEYLESS-GO\* start/stop button on the gear selector lever will have no effect
- the gear selector lever will remain locked in position **P**

The battery is located on the right side of the trunk under the battery cover.

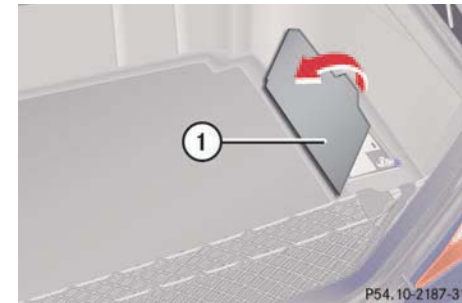

① Battery cover

- ▶ Pull on the outer, right-hand side of cover ① and remove it in the direction of the arrow.

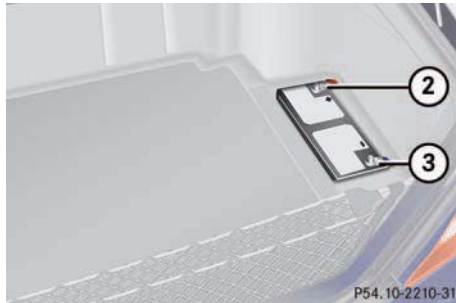

- ② Positive terminal
- ③ Negative terminal

### Disconnecting the battery

- ▶ Turn off all electrical consumers.
- ▶ Open the trunk lid (> page 97).
- ▶ Remove the battery cover ①.
- ▶ Use a 10 mm open-end wrench to disconnect the battery negative lead ③.
- ▶ Remove cover from the positive terminal ②.
- ▶ Disconnect the battery positive lead ②.

### Removing the battery

- ▶ Remove the screw securing the battery.
- ▶ Remove the battery support and bracket.
- ▶ Take out the battery.

## Practical hints

### Battery

### Charging and reinstalling battery

- ▶ Charge battery in accordance with the instructions of the battery charger manufacturer.
- ▶ Reinstall the charged battery. Follow the previously described steps in reverse order.

### Warning!



Never charge a battery while still installed in the vehicle. Gases may escape during charging and cause explosions that may result in paint damage, corrosion or personal injury.



## Practical hints

### Battery

#### Reconnecting the battery

- ▶ Turn off all electrical consumers.
- ▶ Connect the positive lead and fasten its cover ②.
- ▶ Connect negative lead ③.



Never invert the terminal connections.



The battery, its filler caps and the vent tube must always be securely installed when the vehicle is in operation.



The following procedures must be carried out following any interruption of battery power (e.g. due to reconnecting):

- Set the clock (see COMAND operator's manual).
- Resynchronize the ESP (▷ page 316).
- Resynchronize side windows (▷ page 198).
- Resynchronize sliding/pop-up roof (▷ page 202).
- Resynchronize rear seats if they were adjusted five seconds or less before the battery was disconnected.

Batteries contain materials that can harm the environment if disposed of improperly. Large 12-volt storage batteries contain lead. Recycling of batteries is the preferred method of disposal. Many states require sellers of batteries to accept old batteries for recycling.

## ▼ Jump starting

### Warning!



Failure to follow these directions will cause damage to the electronic components, and can lead to a battery explosion and severe injury or death.

Never lean over batteries while connecting or jump starting, you might get injured.

Battery fluid contains sulfuric acid. Do not allow this fluid to come in contact with eyes, skin or clothing. In case it does, immediately flush affected area with water, and seek medical help if necessary.

A battery will also produce hydrogen gas, which is flammable and very explosive. Keep flames or sparks away from battery, avoid improper connection of jumper cables, smoking, etc.

Attempting to jump start a frozen battery can result in it exploding, causing personal injury.

Read all instructions before proceeding.

If the battery is discharged, the engine can be started with jumper cables and the battery of another vehicle. Observe the following:

- Jump starting should only be performed when the engine and catalytic converter are cold.
- Do not start the engine if the battery is frozen. Let the battery thaw out first.
- Only use 12 volt battery to jump start your vehicle. Jump starting with a more powerful battery could damage the vehicle's electrical system, which will not be covered by the Mercedes-Benz Limited Warranty.
- Only use jumper cables with sufficient cross-section and insulated terminal clamps.
- Always make sure that the jumper cables are not on or near pulleys, fans or other parts that move when an engine is started or running.

## Practical hints

### Jump starting



Avoid repeated and lengthy starting attempts.

Do not attempt to start the engine using a battery quick charge unit.

If engine does not run after several unsuccessful starting attempts, have it checked at the nearest authorized Mercedes-Benz Center.

Excessive unburned fuel generated by repeated failed starting attempts may damage the catalytic converter and may present a fire risk.

Make sure the jumper cables do not have loose or missing insulation.

Make sure the cable clamps do not touch any other metal part while the other end is still attached to a battery.



Do not tow-start the vehicle.

## Practical hints

### Jump starting

#### Warning!



Keep flames or sparks away from battery.  
Do not smoke.

Observe all safety instructions and precautions when handling automotive batteries (▷ page 366).

The battery is located on the right side of the trunk under the battery cover (▷ page 366).

- ▶ Make sure the two vehicles do not touch.
- ▶ Turn off all electrical consumers.
- ▶ Apply parking brake.
- ▶ Shift gear selector lever to position **P**.
- ▶ Open the trunk lid.
- ▶ Remove battery cover (▷ page 366).
- ▶ Remove red cover from positive terminal ①.

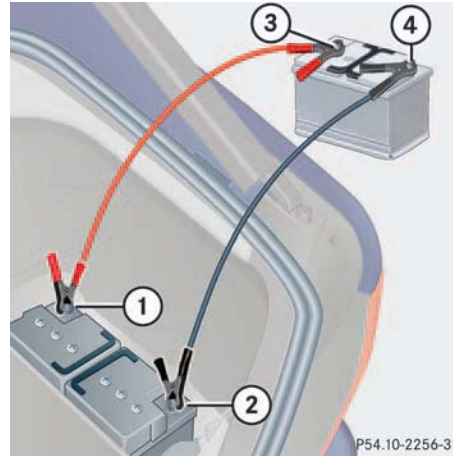

- ① Positive terminal of discharged battery
  - ② Negative terminal of discharged battery
  - ③ Positive terminal of charged battery
  - ④ Negative terminal of charged battery
- ▶ Connect positive terminals ① and ③ of the batteries with the jumper cable. Clamp cable to charged battery ③ first.



Never invert the terminal connections.

- ▶ Start engine of the vehicle with the charged battery and run at idle speed.
- ▶ Connect negative terminals ② and ④ of the batteries with the jumper cable. Clamp cable to charged battery ④ first.
- ▶ Start the engine of the disabled vehicle.

Now you can again turn on the electrical consumers. Do not turn on the lights under any circumstances.

- ▶ Remove the jumper cables first from negative terminals ② and ④ and then from positive terminals ① and ③.

You can now turn on the lights.

- ▶ Have the battery checked at the nearest authorized Mercedes-Benz Center.

## ▼ Towing the vehicle

Mercedes-Benz recommends that the vehicle be transported with all wheels off the ground using flatbed or appropriate wheel lift/dolly equipment. This method is preferable to other types of towing.



Use flatbed or wheel lift/dolly equipment with SmartKey in starter switch turned to position **0**.

Do not tow with sling-type equipment. Towing with sling-type equipment over bumpy roads will damage radiator and supports.

To prevent damage during transport, do not tie down vehicle by its chassis or suspension parts.

Switch off the tow-away alarm (▷ page 85) and the automatic central locking (▷ page 106).

Do not tow-start the vehicle.

When circumstances do not permit the recommended towing methods, the vehicle may be towed with all wheels on the ground or front wheels raised (except vehicles with 4MATIC) only so far as necessary to have the vehicle moved to a safe location where the recommended towing methods can be employed.



Vehicles with 4MATIC:  
Do not tow with one axle raised. Doing so could damage the transfer case, which is not covered by the Mercedes-Benz Limited Warranty.

All wheels must be on or off the ground. Observe instructions for towing the vehicle with all wheels on the ground.

## Practical hints

### Towing the vehicle



If the vehicle is towed with the front axle raised (not permissible for vehicles with 4MATIC), the engine must be shut off (SmartKey in starter switch position **0** or **1**). Otherwise the ESP will immediately be engaged and will apply the rear wheel brakes.

When towing the vehicle with all wheels on the ground, the selector lever must be in position **N** and the SmartKey must be in starter switch position **2**.

When towing the vehicle with all wheels on the ground or the front axle raised, the vehicle may be towed only for distances up to 30 miles (50 km) and at a speed not to exceed 30 mph (50 km/h).

## Practical hints

### Towing the vehicle



To be certain to avoid a possibility of damage to the drive train, however, we recommend the drive shaft be disconnected at the rear axle drive flange (vehicles with 4MATIC: disconnected at the front and rear axle drive flanges) for any towing beyond a short tow to a nearby garage.

#### Warning!



If circumstances require towing the vehicle with all wheels on the ground, always tow with a tow bar if:

- the engine will not run
  - there is a malfunction in the power supply or in the vehicle's electrical system
- as that will be necessary to adequately control the towed vehicle.

Prior to towing the vehicle with all wheels on the ground, make certain that the SmartKey is in starter switch position **2**.

If the SmartKey is left in starter switch position **0** for an extended period of time, it can no longer be turned in the switch. In this case, the steering is locked. To unlock, remove SmartKey from starter switch and re-insert.

#### Warning!



With the engine not running, there is no power assistance for the brake and steering systems. In this case, it is important to keep in mind that a considerably higher degree of effort is necessary to brake and steer the vehicle. Adapt your driving accordingly.



The gear selector lever will remain locked in position **P** and the SmartKey will not turn in the starter switch if the battery is disconnected or discharged. See notes on the battery (▷ page 366) or on jump starting (▷ page 369).



To signal turns while being towed with the hazard warning flasher in use, turn SmartKey in starter switch to position **2** and activate the combination switch for the left or right turn signal in the usual manner – only the selected turn signal will operate.

Upon canceling the turn signal, the hazard warning flasher will operate again.



When towing the vehicle with all wheels on the ground, please note the following:

With the automatic central locking activated and the SmartKey in starter switch position **2**, or KEYLESS-GO\* start/stop button in position **2**, the vehicle doors lock if the left front wheel as well as the right rear wheel are turning at vehicle speeds of approximately 9 mph (15 km/h) or more.

Switch off the tow-away alarm (▷ page 85).

To prevent the vehicle doors from locking, deactivate the automatic central locking (▷ page 106).

Towing of the vehicle should only be done using the properly installed towing eye bolt. Never attach tow cable, tow rope or tow rod to vehicle chassis, frame or suspension parts.

#### Installing towing eye bolt



① Cover on right side of front bumper

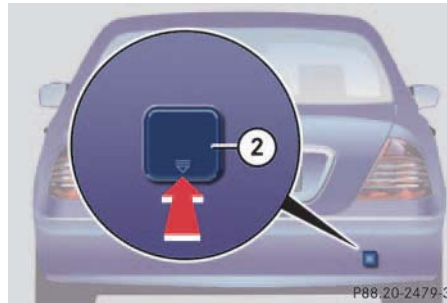

② Cover on right side of rear bumper

## Practical hints

### Towing the vehicle

#### Removing cover

- ▶ Press mark on cover in direction of arrow.
- ▶ Lift cover off to reveal threaded hole for towing eye bolt.

#### Installing towing eye bolt

- ▶ Take towing eye bolt and wheel wrench out of trunk (▷ page 344).
- ▶ Screw towing eye bolt clockwise into its stop and tighten with wheel wrench.

#### Removing towing eye bolt

- ▶ Loosen towing eye bolt counterclockwise with wheel wrench.
- ▶ Unscrew towing eye bolt.
- ▶ Store towing eye bolt and wheel wrench in trunk.

#### Installing cover

- ▶ Fit cover and snap into place.

## Practical hints

### Fuses

#### ▼ Fuses

Your vehicle's electrical fuses are located in various fuse boxes:

- In the dashboard on the passenger side
- In the rear passenger compartment under the right rear seat
- In the engine compartment on the driver's side
- In the engine compartment on the passenger side

The following implements are located in the vehicle tool kit in the trunk (▷ page 344):

- The fuse chart. The amperages of the fuses are also given there.
- Spare fuses
- Special fuse extractor



Only install fuses that have been tested and approved by Mercedes-Benz and that have the specified amperage rating.

Never attempt to repair or bridge a blown fuse. Have the cause determined and remedied by an authorized Mercedes-Benz Center.

### Fuse boxes in passenger compartment

There are two fuse boxes. One fuse box is located in the dashboard on the front passenger side. An additional fuse box is located under the right rear seat.

#### Fuse box in dashboard

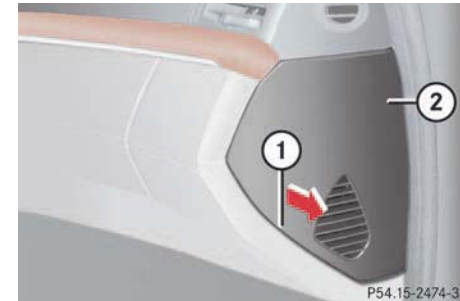

- ① Recess in the cover
- ② Cover

## Practical hints

### Fuses



Do not use sharp objects such as a screw driver to open the fuse box in the dashboard, as this could damage it.

#### Opening

- ▶ Open the front passenger door.
- ▶ Insert flat, blunt object as a lever in recess ① on the edge of cover ②.
- ▶ Loosen cover ② from the dashboard using lever.
- ▶ Using your hands, pull cover ② in the direction of the arrow and remove.

#### Closing

- ▶ Press cover ② back onto the dashboard.

#### Fuse box in the rear passenger compartment

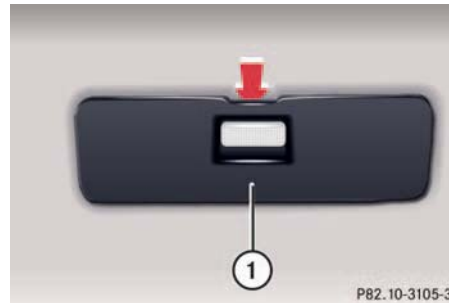

- ① Cover

#### Opening

- ▶ Pull cover ① away from fuse box in direction of arrow.
- ▶ Remove cover rearward.

#### Closing

- ▶ Press cover back on until it engages.

#### Fuse boxes in engine compartment

There are fuse boxes located in the engine compartment on both the driver's and front passenger side in front of the firewall (dividing wall between engine compartment and passenger compartment).

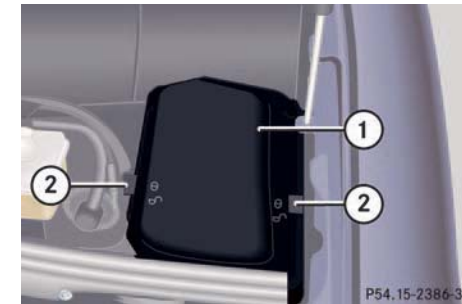

- ① Fuse box cover, driver's side
- ② Slide



## Practical hints

### Fuses

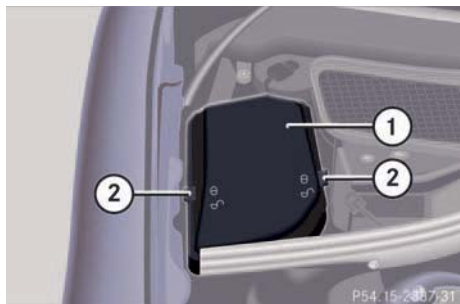

① Fuse box cover, front passenger side

② Slide

#### Opening

- ▶ Push both slides ② to the  symbol.
- ▶ Remove cover ①.

#### Closing

- ▶ Replace cover ① and press it down by hand.
- ▶ Push both slides ② to the  symbol.



The cover must fit properly and the slide must be positioned at the  symbol, as moisture or dirt may impair the functionality of the fuses.

#### Emergency engine shut-down

If the engine can no longer be stopped using the SmartKey or the KEYLESS-GO\* start/stop button, the engine can be turned off by withdrawing two fuses.

For easy removal of fuses, use the fuse extractor (supplied with vehicle tool kit) to pull out the fuses marked on the fuse chart as "ENGINE EMERGENCY STOP".

The fuse chart is also located in the vehicle tool kit (▷ page 344).

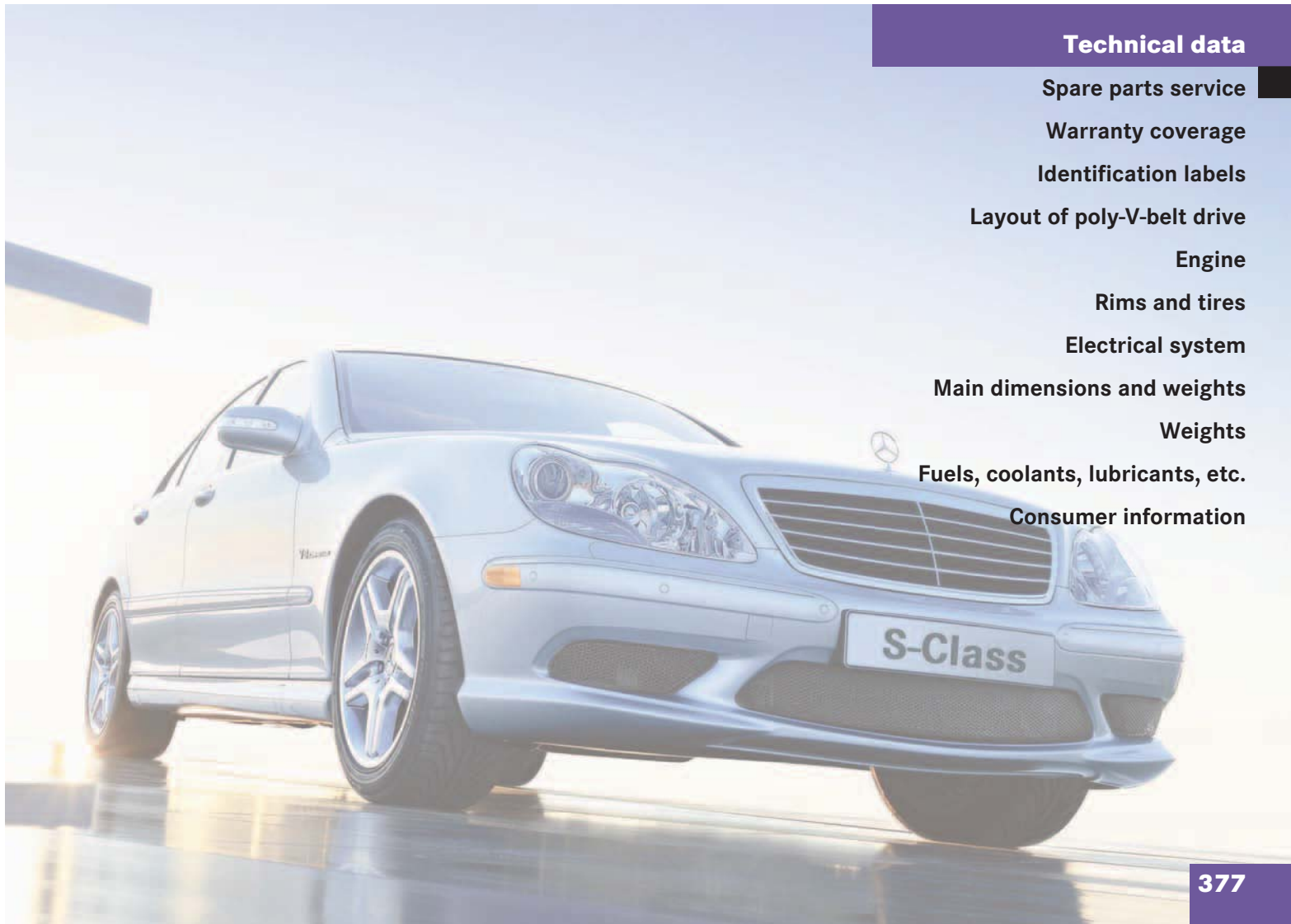

## **Technical data**

**Spare parts service**

**Warranty coverage**

**Identification labels**

**Layout of poly-V-belt drive**

**Engine**

**Rims and tires**

**Electrical system**

**Main dimensions and weights**

**Weights**

**Fuels, coolants, lubricants, etc.**

**Consumer information**

## Technical data

### Spare parts service

The “Technical data” section provides the necessary technical data for your vehicle.

#### ▼ Spare parts service

All authorized Mercedes-Benz Centers maintain a stock of genuine Mercedes-Benz parts required for maintenance and repair work. In addition, strategically located parts distribution centers provide quick and reliable parts service.

More than 300 000 different spare parts for Mercedes-Benz models are available.

Genuine Mercedes-Benz parts are subjected to stringent quality inspections. Each part has been specifically developed, manufactured or selected for and adapted to Mercedes-Benz vehicles.

Therefore, genuine Mercedes-Benz parts should be installed.



The use of non-genuine Mercedes-Benz parts and accessories not authorized by Mercedes-Benz could damage the vehicle, which is not covered by the Mercedes-Benz Limited Warranty, or could compromise the vehicle’s durability or safety.

▼ **Warranty coverage**

Your vehicle is covered under the terms of the warranties printed in the Service and Warranty Information booklet. Your authorized Mercedes-Benz Center will exchange or repair any defective parts originally installed on the vehicle in accordance with the terms of the following warranties:

- New Vehicle Limited Warranty
- Emission System Warranty
- Emission Performance Warranty
- California, Maine, Massachusetts, and Vermont Emission Control Systems Warranty

Replacement parts and accessories are covered by the Mercedes-Benz Spare Parts and Accessories warranties, copies of which are available at any authorized Mercedes-Benz Center.

**Loss of Service and Warranty Information Booklet**

---

Should you lose your Service and Warranty Information booklet, have an authorized Mercedes-Benz Center arrange for a replacement. It will be mailed to you.

## Technical data

### Identification labels

#### ▼ Identification labels

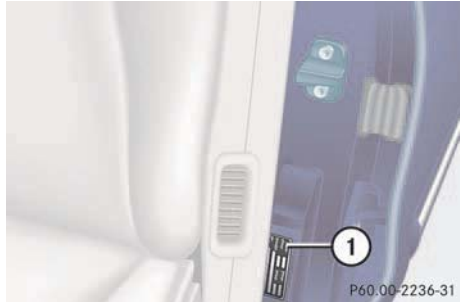

- ① Certification label  
(below driver's door latch)

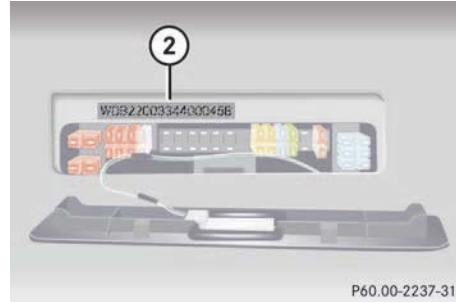

- ② Vehicle Identification Number (VIN)  
(below right rear passenger seat)

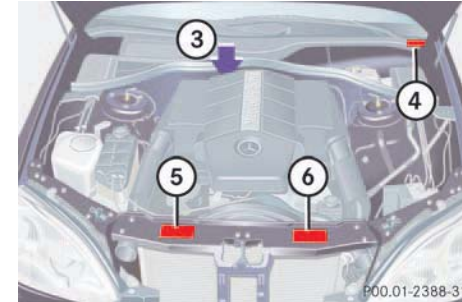

- ③ Engine number (engraved on engine)  
④ VIN, visible (lower edge of windshield)  
⑤ Emission control label  
⑥ Information label, California version  
Vacuum line routing for emission control system

When ordering spare parts, please specify vehicle identification and engine numbers.

▼ Layout of poly-V-belt drive

S 430 / S 500 (all models)

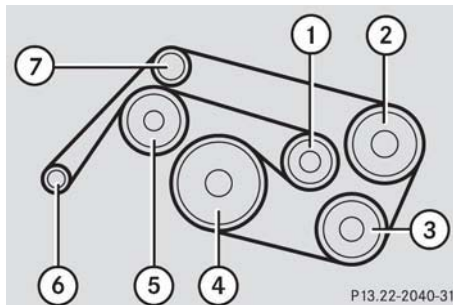

- ① Automatic belt tensioner
- ② ABC tandem pump (pump for power-steering assistance and ABC chassis)
- ③ Air conditioning compressor
- ④ Crankshaft
- ⑤ Coolant pump
- ⑥ Generator (alternator)
- ⑦ Idler pulley

P13.22-2040-31

S 55 AMG

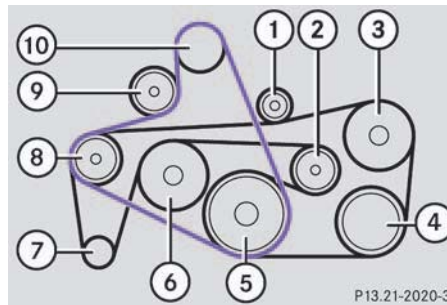

The S 55 AMG has two poly-V-belts (belt one shown in purple/belt two shown in black).

- ① Idler pulley
- ② Automatic belt tensioner
- ③ ABC tandem pump (pump for power-steering assistance and ABC chassis)
- ④ Air conditioning compressor
- ⑤ Crankshaft
- ⑥ Coolant pump
- ⑦ Generator (alternator)
- ⑧ Idler pulley
- ⑨ Automatic belt tensioner
- ⑩ Supercharger

P13.21-2020-31

S 600

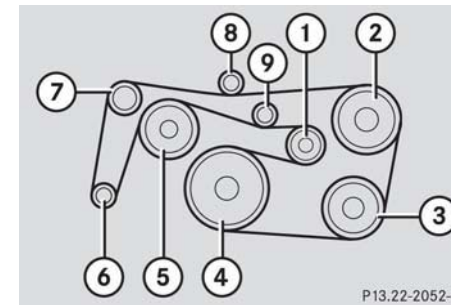

- ① Automatic belt tensioner
- ② ABC tandem pump (pump for power-steering assistance and ABC chassis)
- ③ Air conditioning compressor
- ④ Crankshaft
- ⑤ Coolant pump
- ⑥ Generator (alternator)
- ⑦ Idler pulley
- ⑧ Idler pulley
- ⑨ Idler pulley

P13.22-2052-31

## Technical data

### Engine

#### ▼ Engine

| Model                             | S 430 (220.070, 220.170) <sup>1</sup><br>S 430 4MATIC (220.183) <sup>1</sup> | S 500 (220.175) <sup>1</sup><br>S 500 4MATIC (220.184) <sup>1</sup> |
|-----------------------------------|------------------------------------------------------------------------------|---------------------------------------------------------------------|
| Engine                            | 113                                                                          | 113                                                                 |
| Mode of operation                 | 4-stroke engine, gasoline injection                                          | 4-stroke engine, gasoline injection                                 |
| No. of cylinders                  | 8                                                                            | 8                                                                   |
| Bore                              | 3.54 in (89.90 mm)                                                           | 3.82 in (97.00 mm)                                                  |
| Stroke                            | 3.31 in (84.00 mm)                                                           | 3.31 in (84.00 mm)                                                  |
| Total piston displacement         | 260.3 cu in (4266 cm <sup>3</sup> )                                          | 303.0 cu in (4966 cm <sup>3</sup> )                                 |
| Compression ratio                 | 10:1                                                                         | 10:1                                                                |
| Output acc. to SAE J 1349         | 275 hp / 5750 rpm <sup>2</sup><br>(205 kW / 5750 rpm)                        | 302 hp / 5600 rpm <sup>2</sup><br>(225 kW / 5600 rpm)               |
| Maximum torque acc. to SAE J 1349 | 295 lb-ft / 3000 - 4400 rpm<br>(400 Nm / 3000 - 4400 rpm)                    | 339 lb-ft / 2700 - 4250 rpm<br>(460 Nm / 2700 - 4250 rpm)           |
| Maximum engine speed              | 6000 rpm                                                                     | 6000 rpm                                                            |
| Firing order                      | 1-5-4-2-6-3-7-8                                                              | 1-5-4-2-6-3-7-8                                                     |
| Poly-V-belt                       | 2380 mm                                                                      | 2380 mm                                                             |

<sup>1</sup> The quoted data apply only to the standard vehicle. See an authorized Mercedes-Benz Center for the corresponding data of all special bodies and special equipment.

<sup>2</sup> Premium fuel required. Performance may vary with fuel octane rating.

## Technical data

### Engine

| Model                             | S 55 AMG (220.174) <sup>1</sup>                               | S 600 (220.176) <sup>1</sup>                                  |
|-----------------------------------|---------------------------------------------------------------|---------------------------------------------------------------|
| Engine                            | 113                                                           | 275                                                           |
| Mode of operation                 | 4-stroke engine, gasoline injection                           | 4-stroke engine, gasoline injection                           |
| No. of cylinders                  | 8                                                             | 12                                                            |
| Bore                              | 3.82 in (97.00 mm)                                            | 3.23 in (82.00 mm)                                            |
| Stroke                            | 3.60 in (92.00 mm)                                            | 3.43 in (87.00 mm)                                            |
| Total piston displacement         | 331.8 cu in (5439 cm <sup>3</sup> )                           | 336.4 cu in (5513 cm <sup>3</sup> )                           |
| Compression ratio                 | 9:1                                                           | 9:1                                                           |
| Output acc. to SAE J 1349         | 493 hp / 6 100 rpm <sup>2</sup><br>(368 kW / 6 100 rpm)       | 493 hp / 5 000 rpm <sup>2</sup><br>(368 kW / 5 000 rpm)       |
| Maximum torque acc. to SAE J 1349 | 516 lb-ft / 2 750 - 4 000 rpm<br>(700 Nm / 2 750 - 4 000 rpm) | 590 lb-ft / 1 800 - 3 500 rpm<br>(800 Nm / 1 800 - 3 500 rpm) |
| Maximum engine speed              | 6 500 rpm                                                     | 5 950 rpm                                                     |
| Firing order                      | 1-5-4-2-6-3-7-8                                               | 1-12-5-8-3-10-6-7-2-11-4-9                                    |
| Poly-V-belt                       | Belt one: 1289 mm<br>Belt two: 2462 mm                        | 2335 mm                                                       |

<sup>1</sup> The quoted data apply only to the standard vehicle. See an authorized Mercedes-Benz Center for the corresponding data of all special bodies and special equipment.

<sup>2</sup> Premium fuel required. Performance may vary with fuel octane rating.



## Technical data

### Rims and tires

#### ▼ Rims and tires

Use only tires and rims which have been specifically developed for your vehicle and tested and approved by Mercedes-Benz. Other tires and rims can have detrimental effects, such as:

- Poor handling characteristics
- Increased noise
- Increased fuel consumption



Moreover, tires and rims not approved by Mercedes-Benz may, under load, exhibit dimensional variations and different tire deformation characteristics that could cause them to come into contact with the vehicle body or axle parts. This may result in damage to the tires or the vehicle.



Further information on tires and rims is available at any authorized Mercedes-Benz Center. A tire inflation pressure table is located on the fuel filler flap of the vehicle. The tire pressure should be checked regularly and should only be adjusted on cold tires. Follow tire manufacturer's maintenance recommendation included with vehicle.

## Technical data

### Rims and tires

#### Same size tires

|                                            | S 430, S 430 4MATIC<br>S 500, S 500 4MATIC<br>(except Sport Package* and<br>except Appearance<br>Package*) | S 600<br>(except Sport Package* and<br>except Appearance<br>Package*)        | S 430, S 430 4MATIC<br>S 500, S 500 4MATIC<br>S 600<br>(Appearance Package*) |
|--------------------------------------------|------------------------------------------------------------------------------------------------------------|------------------------------------------------------------------------------|------------------------------------------------------------------------------|
| <b>Rims (light alloy)</b>                  | 7½ J x17 H2                                                                                                | 8 J x18 H2 <sup>1</sup>                                                      | 8 J x18 H2 <sup>1</sup>                                                      |
| <b>Wheel offset</b>                        | 1.81 in (46 mm)                                                                                            | 1.73 in (44 mm)                                                              | 1.73 in (44mm)                                                               |
| <b>Summer tires (radial-ply tires)</b>     | -                                                                                                          | 245/45 R18 96Y <sup>1</sup>                                                  | 245/45 R18 96Y <sup>1</sup>                                                  |
| <b>All-season tires (radial-ply tires)</b> | 225/55 R17 97H M+S                                                                                         | -                                                                            | -                                                                            |
| <b>Winter tires (radial-ply tires)</b>     | 225/55 R17 97H M+S                                                                                         | 245/45 R18 100V XL M+S <sup>1</sup><br>or<br>245/45 R18 96H M+S <sup>1</sup> | 245/45 R18 100V XL M+S <sup>1</sup><br>or<br>245/45 R18 96H M+S <sup>1</sup> |

<sup>1</sup> For use with snow chains contact an authorized Mercedes-Benz Center

## Technical data

### Rims and tires

|                                            | <b>S 430, S 500<br/>S 600<br/>(Sport Package*)<br/>S 55 AMG</b>                  | <b>S 430 4MATIC, S 500 4MATIC<br/>(Sport Package*)</b>                           |
|--------------------------------------------|----------------------------------------------------------------------------------|----------------------------------------------------------------------------------|
| <b>Rims (light alloy)</b>                  | 8 J x18 H2 <sup>2</sup><br>or<br>8½ J x18 EH2 <sup>3</sup>                       | 8 J x18 H2 <sup>1,2</sup> or 8½ J x18 EH2 <sup>3</sup>                           |
| <b>Wheel offset</b>                        | 1.73 in (44mm)                                                                   | 1.73 in (44 mm)                                                                  |
| <b>Summer tires (radial-ply tires)</b>     | -                                                                                | 245 / 45 R18 100Y XL                                                             |
| <b>All-season tires (radial-ply tires)</b> | -                                                                                | -                                                                                |
| <b>Winter tires (radial-ply tires)</b>     | 245 / 45 R18 100V XL M+S <sup>2</sup><br>or<br>245 / 45 R18 96H M+S <sup>2</sup> | 245 / 45 R18 100V XL M+S <sup>2</sup><br>or<br>245 / 45 R18 96H M+S <sup>2</sup> |

<sup>1</sup> For use with winter tires only

<sup>2</sup> For use with snow chains contact an authorized Mercedes-Benz Center

<sup>3</sup> Must not be used with snow chains

## Technical data

### Rims and tires

#### Mixed size tires

|                    |                                        | <b>S 430 , S 500, S 600 (Sport Package*)</b>                             | <b>S 55 AMG</b>                   |
|--------------------|----------------------------------------|--------------------------------------------------------------------------|-----------------------------------|
| <b>Front axle:</b> | <b>AMG light alloy rims</b>            | 8½ J x 18 EH2 <sup>1</sup>                                               | 8½ J x 18 EH2 <sup>1</sup>        |
|                    | <b>Wheel offset</b>                    | 1.73 in (44 mm)                                                          | 1.73 in (44 mm)                   |
|                    | <b>Summer tires (radial-ply tires)</b> | 245 / 45 R18 100Y XL<br>or<br>245 / 45 R18 96Y                           | 245 / 45 R18 100Y XL              |
| <b>Rear axle:</b>  | <b>AMG light alloy rims</b>            | 9 J x 18 EH2 <sup>1</sup>                                                | 9 J x 18 EH2 <sup>1</sup>         |
|                    | <b>Wheel offset</b>                    | 1.73 in (44 mm)                                                          | 1.73 in (44 mm)                   |
|                    | <b>Summer tires (radial-ply tires)</b> | 265 / 40 R18 101Y XL <sup>1</sup><br>or<br>265 / 40 R18 97Y <sup>1</sup> | 265 / 40 R18 101Y XL <sup>1</sup> |

<sup>1</sup> Must not be used with snow chains

## Technical data

### Rims and tires

#### Spare wheel

|                                            | <b>S 430, S 430 4MATIC<br/>S 500, S 500 4MATIC<br/>(except Sport Package* and except<br/>Appearance Package*)</b> | <b>S 430, S 430 4MATIC, S 500, S 500 4MATIC<br/>(Sport Package* and Appearance Package*),<br/>S 600, S 55 AMG</b> |
|--------------------------------------------|-------------------------------------------------------------------------------------------------------------------|-------------------------------------------------------------------------------------------------------------------|
| <b>Rims (light alloy)</b>                  | 7½ J x 17 H2                                                                                                      | 8 J x 18 H2                                                                                                       |
| <b>Wheel offset</b>                        | 2.0 in (51 mm)                                                                                                    | 1.73 in (44 mm)                                                                                                   |
| <b>Summer tires (radial-ply tires)</b>     | -                                                                                                                 | 245 / 45 R18 96Y                                                                                                  |
| <b>All-season tires (radial-ply tires)</b> | 225 / 55 R17 97H M+S                                                                                              | -                                                                                                                 |

**Technical data****Electrical system****▼ Electrical system**

| Model                  | S 430, S 500                        | S 55 AMG                   | S 600                      |
|------------------------|-------------------------------------|----------------------------|----------------------------|
| Generator (alternator) | 14 V / 150 A                        | 14 V / 180 A               | 14 V / 220 A               |
| Starter motor          | 12 V / 1.7 kW                       | 12 V / 1.7 kW              | 12 V / 1.7 kW              |
| Battery                | 12 V / 95 Ah                        | 12 V / 95 Ah               | 12 V / 95 Ah               |
| Spark plugs            | Bosch F 8 DPP 332<br>NGK PFR 5 R-11 | NGK IL FR 6 A              | NGK IFR 6Q-G               |
| Electrode gap          | 0.039 in (1.0 mm)                   | 0.031 in (0.8 mm)          | 0.028 in (0.7 mm)          |
| Tightening torque      | 15 – 22 lb-ft (20 – 30 Nm)          | 18 – 22 lb-ft (25 – 30 Nm) | 15 – 22 lb-ft (20 – 30 Nm) |

## Technical data

### Main dimensions and weights

#### ▼ Main dimensions and weights

##### Main dimensions

| Model                  | S 430 (220.070)    | S 430 (220.170)<br>S 430 4MATIC (220.183)<br>S 500 (220.175)<br>S 500 4MATIC (220.184) | S 55 AMG (220.174) | S 600 (220.176)    |
|------------------------|--------------------|----------------------------------------------------------------------------------------|--------------------|--------------------|
| Overall vehicle length | 198.3 in (5038 mm) | 203.1 in (5158 mm)                                                                     | 203.1 in (5158 mm) | 203.1 in (5158 mm) |
| Overall vehicle width  | 73.0 in (1855 mm)  | 73.0 in (1855 mm)                                                                      | 73.0 in (1855 mm)  | 73.0 in (1855 mm)  |
| Overall vehicle height | 57.2 in (1454 mm)  | 57.2 in (1454 mm)                                                                      | 57.2 in (1454 mm)  | 57.4 in (1457 mm)  |
| Wheelbase              | 116.7 in (2965 mm) | 121.5 in (3085 mm)                                                                     | 121.5 in (3085 mm) | 121.5 in (3085 mm) |
| Track, front           | 62.0 in (1574 mm)  | 62.0 in (1574 mm)                                                                      | 62.1 in (1578 mm)  | 62.0 in (1574 mm)  |
| Track, rear            | 62.0 in (1574 mm)  | 62.0 in (1574 mm)                                                                      | 62.1 in (1578 mm)  | 62.0 in (1574 mm)  |

##### Weights

|                 |                  |
|-----------------|------------------|
| Max. roof load  | 220 lbs (100 kg) |
| Max. trunk load | 220 lbs (100 kg) |

## Technical data

### Fuels, coolants, lubricants, etc.

#### ▼ Fuels, coolants, lubricants, etc.

##### Capacities

Vehicle components and their respective lubricants must match. Therefore use only brands tested and approved by us.

Please refer to the Factory Approved Service Products pamphlet, or inquire at your Mercedes-Benz Center.

|                                        | Model                        | Capacity                   | Fuels, coolants, lubricants, etc.          |
|----------------------------------------|------------------------------|----------------------------|--------------------------------------------|
| <b>Engine with oil filter</b>          | S 430                        | 8.5 US qt. (8.0 l)         | Approved engine oils                       |
|                                        | S 500                        | 8.5 US qt. (8.0 l)         |                                            |
|                                        | S 55 AMG                     | 7.9 US qt. (7.5 l)         |                                            |
|                                        | S 600                        | 9.5 US qt. (9.0 l)         |                                            |
| <b>Automatic transmission</b>          | S 600                        | 9.1 US qt. (8.6 l)         | MB Automatic Transmission Oil              |
|                                        |                              | 8.1 US qt. (7.7 l)         |                                            |
| <b>Rear axle</b>                       | S 55 AMG<br>S 600            | 1.7 US qt. (1.6 l)         | Hypoid gear oil SAE 85 W 90                |
|                                        |                              | 2.1 US qt. (2.0 l)         |                                            |
|                                        |                              | 2.1 US qt. (2.0 l)         |                                            |
| <b>Front axle</b>                      | S 430 4MATIC<br>S 500 4MATIC | 0.63 US qt. (0.6 l)        | Hypoid gear oil SAE 85 W 90                |
|                                        |                              |                            |                                            |
| <b>Transfer case</b>                   | S 430 4MATIC<br>S 500 4MATIC | 0.62 US qt. (0.585 l)      | MB Transfer Case Oil                       |
| <b>Hydraulic system for ADS or ABC</b> |                              | 4.2 US qt. (4.0 l)         | MB Hydraulic Fluids                        |
| <b>Power steering</b>                  |                              | approx. 1.1 US qt. (1.0 l) | MB Power Steering Fluid (Pentosin CHF 11S) |



## Technical data

### Fuels, coolants, lubricants, etc.

|                                                        | Model                              | Capacity                                                                                    | Fuels, coolants, lubricants, etc.                                                   |
|--------------------------------------------------------|------------------------------------|---------------------------------------------------------------------------------------------|-------------------------------------------------------------------------------------|
| <b>Front wheel hubs</b>                                |                                    | approx. 3.5 oz. (100 g) each                                                                | High-temperature roller bearing grease                                              |
| <b>Brake system</b>                                    |                                    | 0.7 US qt. (0.7 l)                                                                          | MB Brake Fluid (DOT 4+)                                                             |
| <b>Cooling system</b>                                  | S 430, S 500<br>S 55 AMG<br>S 600  | approx. 12.1 US qt. (11.5 l)<br>approx. 14.3 US qt. (13.5 l)<br>approx. 15.85 US qt. (15 l) | MB 325.0 Anticorrosion / Antifreeze                                                 |
| <b>Low temperature cooling system</b>                  | S 600                              | 2.3 US qt. (2.2 l)                                                                          | MB 325.0 Anticorrosion / Antifreeze                                                 |
| <b>Fuel tank including a reserve of</b>                | S 430, S 500,<br>S 55 AMG<br>S 600 | 23.2 US gal. (88.0 l)<br>2.9 US gal. (11.0 l))                                              | Premium unleaded gasoline:<br>Minimum Posted Octane 91<br>(Avg. of 96 RON / 86 MON) |
| <b>Air conditioning system</b>                         |                                    |                                                                                             | R-134a refrigerant and special PAG lubricant oil (never R-12)                       |
| <b>Windshield washer</b>                               |                                    | 3.2 US qt. (3.0 l)                                                                          | MB Windshield Washer Concentrate <sup>1</sup>                                       |
| <b>Windshield washer and headlamp cleaning system:</b> |                                    | 7.1 US qt. (6.7 l)                                                                          | MB Windshield Washer Concentrate <sup>1</sup>                                       |

<sup>1</sup> Use MB Windshield Washer Concentrate "S" and water for temperatures above freezing or MB Windshield Washer Concentrate "S" and commercially available pre-mixed windshield washer solvent / antifreeze for temperatures below freezing point. Follow suggested mixing ratios (▷ page 398).

#### Engine oils

Engine oils are specifically tested for their suitability in our engines. Therefore, only use engine oils approved by Mercedes-Benz. Information on approved brands is available in the Factory Approved Service Products pamphlet, or at an authorized Mercedes-Benz Center.



Always check the oil filler cap (▷ page 277) for important information pertaining to the engine oil needing to meet a specific Mercedes-Benz specification (e.g. MB 229.5). If such information is printed on the oil filler cap, only use an engine oil from the list of approved engine oils in the Factory Approved Service Products pamphlet that meets the specification indicated on the oil filler cap.

Using engine oils of other specification may cause the FSS to incorrectly determine the next service interval and will result in engine damage not covered by the Mercedes-Benz Limited Warranty.

Please follow FSS recommendations for scheduled oil changes. Failure to do so could result in engine damage not covered by the Mercedes-Benz Limited Warranty.

#### Engine oil additives

Do not blend oil additives with engine oil. They may damage the engine.

Damage or malfunctions resulting from blending oil additives are not covered by the Mercedes-Benz Limited Warranty.

#### Air conditioning refrigerant

R-134a (HFC) refrigerant and special PAG lubricating oil is used in the air conditioning system.

Never use R-12 (CFC) or mineral-based lubricating oil. Otherwise damage to the system will occur.

## Technical data

### Fuels, coolants, lubricants, etc.

#### Brake fluid

During vehicle operation, the boiling point of the brake fluid is continuously reduced through the absorption of moisture from the atmosphere. Under extremely strenuous operating conditions, this moisture content can lead to the formation of bubbles in the system, thus reducing the system's efficiency.

Therefore, the brake fluid must be replaced every two years, preferably in the spring.

Only brake fluid approved by Mercedes-Benz is recommended. Your authorized Mercedes-Benz Center will provide you with additional information.

#### Premium unleaded gasoline



To maintain the engine's durability and performance, premium unleaded gasoline must be used. If premium unleaded gasoline is not available and low octane fuel is used, follow these precautions:

- Have the fuel tank only partially filled with unleaded regular and fill up with premium unleaded as soon as possible.
- Avoid full throttle driving and abrupt acceleration.
- Do not exceed an engine speed of 3000 rpm if the vehicle is loaded with a light load such as two persons and no luggage.
- Do not exceed 2 / 3 of maximum accelerator pedal position if the vehicle is fully loaded or operating in mountainous terrain.

#### Fuel requirements

Use only premium unleaded fuel:

- The octane number (posted at the pump) must be 91 min. It is an average of both the Research (R) octane number and the Motor (M) octane number:  $(R+M) / 2$ . This is also known as the ANTI-KNOCK INDEX.

Unleaded gasoline containing oxygenates such as Ethanol, IPA, IBA and TBA can be used provided the ratio of any one of these oxygenates to gasoline does not exceed 10%; MTBE must not exceed 15%.

The ratio of Methanol to gasoline must not exceed 3% plus additional co-solvents.

Using mixtures of Ethanol and Methanol is not allowed. Gasohol, which contains 10% Ethanol and 90% unleaded gasoline, can be used.

These blends must also meet all other fuel requirements, such as resistance to spark knock, boiling range, vapor pressure, etc.

#### Gasoline additives

A major concern among engine manufacturers is carbon build-up caused by gasoline. Mercedes-Benz recommends only the use of quality gasoline containing additives that prevent the build-up of carbon deposits.

After an extended period of using fuels without such additives, carbon deposits can build up especially on the intake valves and in the combustion area, leading to engine performance problems such as:

- Warm-up hesitation
- Unstable idle
- Knocking / pinging
- Misfire
- Power loss

Do not blend any specific fuel additives with fuel. This only results in unnecessary cost and may be harmful to the engine operation.

Damage or malfunctions resulting from poor fuel quality or from blending specific fuel additives are not covered by the Mercedes-Benz Limited Warranty.

#### Coolants

The engine coolant is a mixture of water and anticorrosion / antifreeze, which provides:

- Corrosion protection
- Freeze protection
- Boiling protection (by increasing the boiling point)

The cooling system was filled at the factory with a coolant providing freeze protection to approximately  $-22^{\circ}\text{F}$  ( $-30^{\circ}\text{C}$ ) and corrosion protection.

If the antifreeze mixture is effective to  $-22^{\circ}\text{F}$  ( $-30^{\circ}\text{C}$ ), the boiling point of the coolant in the pressurized cooling system is reached at approximately  $266^{\circ}\text{F}$  ( $130^{\circ}\text{C}$ ).

## Technical data

### Fuels, coolants, lubricants, etc.

The coolant solution must be used year-round to provide the necessary corrosion protection and increase boil-over protection. Refer to Service Booklet for replacement interval.

Coolant system design and coolant used stipulate the replacement interval. The replacement interval published in the Service Booklet is only applicable if MB 325.0 anticorrosion/antifreeze solution or other Mercedes-Benz approved products of equal specification (see Factory Approved Service Products pamphlet) are used to renew the coolant concentration or bring it back up to the proper level.

To provide important corrosion protection, the solution must be at least 45% anticorrosion / antifreeze [equivalent to freeze protection to approximately - 22°F (-30°C)]. If you use a solution that is more than 55% anticorrosion / antifreeze [freeze protection to approximately - 49°F (-45°C)], the engine temperature will increase due to the lower heat transfer capa-

bility of the solution. Therefore, do not use more than this amount of anticorrosion / antifreeze.

If the coolant level is low, water and MB 325.0 Anticorrosion / Antifreeze should be used to bring it up to the proper level (have cooling system checked for signs of leakage).

The water in the cooling system must meet minimum requirements, which are usually satisfied by normal drinking water. If you are not sure about the water quality, consult an authorized Mercedes-Benz Center.

### Anticorrosion / antifreeze

Your vehicle contains a number of aluminum parts. The use of aluminum components in motor vehicle engines necessitates that anticorrosion/ antifreeze coolant used in such engines be specifically formulated to protect the aluminum parts. (Failure to use such anticorrosion/antifreeze coolant will result in a significantly shortened service life.)

Therefore, the following product is strongly recommended for use in your vehicle:  
Mercedes-Benz 325.0  
Anticorrosion / Antifreeze Agent.

Before the start of the winter season (or once a year in hot southern regions), you should have the anticorrosion / antifreeze concentration checked. The coolant is also regularly checked each time you bring your vehicle to an authorized Mercedes-Benz Center for service.

*Anticorrosion/antifreeze quantity*

| Model                                         | Approx. freeze protection |                     |
|-----------------------------------------------|---------------------------|---------------------|
|                                               | - 35°F (- 37°C)           | - 49°F (- 45°C)     |
| <b>S 430, S 500</b>                           | 6.1 US qt. (5.75 l)       | 6.7 US qt. (6.3 l)  |
| <b>S 600 (main cooling system)</b>            | 7.9 US qt. (7.5 l)        | 8.7 US qt. (8.25 l) |
| <b>S 600 (low temperature cooling system)</b> | 1.2 US qt. (1.1 l)        | 1.3 US qt. (1.2 l)  |
| <b>S 55 AMG</b>                               | 7.1 US qt. (6.75 l)       | 7.8 US qt. (7.4 l)  |

## Technical data

### Fuels, coolants, lubricants, etc.

#### Windshield and headlamp washer system

Both the windshield and headlamp washer systems are supplied from the windshield washer fluid reservoir.

The washer fluid reservoir has a capacity of approximately:

- 3.2 US qt. (3.0 l) in vehicles without headlamp cleaning system\*
- 7.4 US qt. (7.0 l) in vehicles with headlamp cleaning system\* or heated reservoir

- ▶ Refill the reservoir with MB Windshield Washer Concentrate and water (or concentrate and commercially available premixed windshield washer solvent / antifreeze, depending on ambient temperatures).

#### Warning



Washer solvent / antifreeze is highly flammable. Do not spill washer solvent / antifreeze on hot engine parts, because it may ignite and burn. You could be seriously burned.

#### Windshield and headlamp washer fluid mixing ratio

For temperatures above freezing point, use MB Windshield Washer Concentrate “S” and water:

- 1 part “S” to 100 parts water  
[40 ml “S” to 1 gallon (4 liters) water].

For temperatures below freezing point, use MB Windshield Washer Concentrate “S” and commercially available premixed windshield washer solvent / antifreeze:

- 1 part “S” to 100 parts solvent  
[40 ml “S” to 1 gallon (4 liters) solvent].

### ▼ Consumer information

The following text is published as required of all manufacturers of passenger cars under Title 49, Code of U.S. Federal Regulations, Part 575 pursuant to the “National Traffic and Motor Vehicle Safety Act of 1966.”

#### Uniform tire quality grading

Quality grades can be found, where applicable, on the tire sidewall between tread shoulder and maximum section width. For example:

| Tread wear | Traction | Temperature |
|------------|----------|-------------|
| 200        | AA       | A           |

All passenger car tires must conform to federal safety requirements in addition to these grades.

#### Tread wear

The tread wear grade is a comparative rating based on the wear rate of the tire when tested under controlled conditions on a specified government test course. For example, a tire graded 150 would wear one and one-half (1½) times as well on the government course as a tire graded 100. The relative performance of tires depends upon the actual conditions of their use, however, and may depart significantly from the norm due to variations in driving habits, service practices and differences in road characteristics and climate.

## Technical data

### Consumer information

#### Traction

The traction grades - from highest to lowest - are AA, A, B, and C. Those grades represent the tire’s ability to stop on wet pavement as measured under controlled conditions on specified government test surfaces of asphalt and concrete. A tire marked C may have poor traction performance.

#### Warning



The traction grade assigned to this tire is based on straight-ahead braking traction tests, and does not include acceleration, cornering, hydroplaning, or peak traction characteristics.



## Technical data

### Consumer information

#### Temperature

The temperature grades are A (the highest), B, and C, representing the tire's resistance to the generation of heat and its ability to dissipate heat when tested under controlled conditions on a specified indoor laboratory test wheel. Sustained high temperature can cause the material of the tire to degenerate and reduce tire life, and excessive temperature can lead to sudden tire failure. Grade C corresponds to a level of performance which all passenger car tires must meet under the Federal Motor Vehicle Safety Standard No. 109. Grades B and A represent higher levels of performance on the laboratory test wheel than the minimum required by law.

#### Warning



The temperature grade for this tire is established for a tire that is properly inflated and not overloaded. Excessive speed, underinflation, or excessive loading, either separately or in combination, can cause excessive heat build-up and possible tire failure.

**ABC**

(Active Body Control)

Active, computer-controlled system that hydraulically adjusts the suspension at all four wheels in response to various driving situations.

**ABS**

(Antilock Brake System)

Prevents the wheels from locking up during braking so that the vehicle can continue to be steered.

**Alignment bolt**

Metal pin with thread. The centering pin is an aid used when changing a tire to align the wheel with the wheel hub.

**BabySmart™ airbag deactivation system**

This system detects if a special system compatible child restraint seat is installed on the front passenger seat. The system will automatically deactivate the passenger front airbag when such a seat is properly installed (indicator lamp PASSENGER AIRBAG OFF in the center console comes on). See an authorized Mercedes-Benz Center for availability.

**BabySmart™ compatible child seats**

Special restraint system for children. The sensor system for the passenger seat prevents deployment of the passenger front airbag if a BabySmart™ compatible child seat is installed.

**BAS**

(Brake Assist System)

System for potentially reducing braking distances in emergency braking situations. The system is activated when it senses an emergency based on how fast the brake is applied.

**Bi-xenon headlamps**

Headlamps which use an electric arc as the light source and produce a more intense light than filament headlamps. Bi-xenon headlamps produce low beam and high beam.

## Technical terms

### **CAC**

(Customer Assistance Center)  
Mercedes-Benz customer service center, which can help you with any questions about your vehicle and provide assistance in the event of a breakdown.

### **CAN system**

(Controller Area Network)  
Data bus network serving to control vehicle functions such as door locking or windshield wiping.

### **Cockpit**

All instruments, switches, buttons and indicator/warning lamps in the passenger compartment needed for vehicle operation and monitoring.

### **COMAND**

(Cockpit Management and Data System)  
Information and operating center for vehicle sound and communications systems, including the radio and navigation system, as well as other optional equipment (CD changer, telephone, etc.).

### **Control system**

The control system is used to call up vehicle information and to change component settings. Information and messages appear in the multifunction display. The driver uses the buttons on the multifunction steering wheel to navigate through the system and to adjust settings.

### **Cruise control**

Driving convenience system for automatically maintaining the vehicle speed set by the driver.

### **Distronic\***

A driving convenience cruise control system which helps the driver maintain a pre-selected speed:

- If there is no vehicle directly ahead, the system operates in the same way as conventional ->cruise control.
- If a slower moving vehicle is ahead, Distronic will reduce your vehicle speed to the extent permitted by reduced throttle and up to 20% braking power to maintain the preset minimum following distance.

### **Engine number**

The number set by the manufacturer and stamped on the cylinder block to uniquely identify each engine produced.

### **Engine oil viscosity**

Measurement for the inner friction (viscosity) of the oil at different temperatures. The higher the temperature an oil can tolerate without becoming thin, or the lower the temperature it can tolerate without becoming viscous, the better the viscosity.

### **ESP**

(Electronic Stability Program)  
Improves vehicle handling and directional stability.

### **ETD**

(Emergency Tensioning Device)  
Device which deploys in certain frontal and rear collisions exceeding the system's threshold to tighten the seat belts.  
->SRS

### **FSS**

(Flexible Service System)  
Service indicator in the multifunction display that informs the driver when the next vehicle maintenance service is due.

### **Gear range**

Number of gears which are available to the automatic transmission for shifting. The automatic gear shifting process can be adapted to specific operating conditions using the selector lever.

### **GPS**

(Global Positioning System)  
Satellite-based system for relaying geographic location information to and from vehicles equipped with special receivers. Employs DVD digital maps for navigation.

### **Instrument cluster**

The displays and indicator/warning lamps in the driver's field of vision, including the tachometer, speedometer, engine temperature and fuel gauge.

### **KEYLESS-GO\***

System for entering and operating the vehicle without the use of a SmartKey.

### **Kickdown**

Depressing the accelerator past the point of resistance shifts the transmission down to the lowest possible gear. This very quickly accelerates the vehicle and should not be used for normal acceleration needs.

### **Lock button**

Button on the door which indicates whether the door is locked or unlocked. Pushing the lock button down on an individual door from inside will lock that door.

### **Memory function\***

Used to store three individual seat, steering wheel and exterior mirror positions for each SmartKey or SmartKey with KEYLESS-GO\*.

## Technical terms

### **MON**

(Motor Octane Number)

The Motor Octane Number for gasoline as determined by a standardized method. It is an indication of a gasoline's ability to resist undesired detonation (knocking). The average of both the MON (Motor Octane Number) and ->RON (Research Octane Number) is posted at the pump, also known as ANTI-KNOCK INDEX.

### **Multifunction display**

Display field in the speedometer used to present information provided by the control system.

### **Multifunction steering wheel**

Steering wheel with buttons for operating the control system.

### **Overspeed range**

Engine speeds within the red marking of the tachometer dial. Avoid this engine speed range, as it may result in serious engine damage that is not covered by the Mercedes-Benz Limited Warranty.

### **Parktronic\***

System which uses visual and acoustic signals to assist the driver during parking maneuvers.

### **Poly-V-belt drive**

Drives engine components (alternator, AC compressor, etc.) from the engine.

### **Power train**

Collective term designating all components used to generate and transmit motive power to the drive axles, including:

- Engine
- Clutch/torque converter
- Transmission
- Transfer case
- Drive shaft
- Differential
- Axle shafts/axles

### **Program mode selector switch**

Used to switch the automatic transmission between standard operation **S** and comfort operation **C**.

S 55 AMG with steering wheel gearshift control and manual shift program: in addition to **S** and **C** (see above), you can use **M** for manual operation

**Remote Vehicle Diagnostics**

Transmission of vehicle data and current location to the Mercedes-Benz Customer Assistance Center for subscribers to the Tele Aid service.

**REST**

(Residual engine heat utilization)  
Feature that uses the engine heat stored in the coolant to heat the vehicle interior for a short time after the engine has been turned off.

**Restraint systems**

Seat belts, belt tensioners, airbags and child restraint systems. As independent systems, their protective functions complement one another.

**RON**

(Research Octane Number)  
The Research Octane Number for gasoline as determined by a standardized method. It is an indication of a gasoline's ability to resist undesired detonation (knocking). The average of both the  $\rightarrow$ MON (Motor Octane Number) and RON (Research Octane Number) is posted at the pump, also known as ANTI-KNOCK INDEX.

**Shift lock**

When the vehicle is parked, this lock prevents the transmission selector lever from being inadvertently moved out of position **P** without the SmartKey turned and the brake pedal depressed.

**SRS**

(Supplemental Restraint System)  
Seat belts, emergency tensioning device and airbags. Though independent systems, they are closely interfaced to provide effective occupant protection.

**Tele Aid System**

(Telematic Alarm Identification on Demand)  
The Tele Aid system consists of three types of response: automatic and manual emergency, Roadside Assistance and information. Tele Aid is initially activated by completing a subscriber agreement and placing an acquaintance call.  
The Tele Aid system is operational provided that the vehicle's battery is charged, properly connected, not damaged and cellular and GPS coverage is available.

**Telematics\***

A combination of the terms "telecommunications" and "informatics."

**Tightening torque**

Force times lever arm (e.g. a lug wrench) with which threaded fasteners such as wheel bolts are tightened.

## Technical terms

### **Tire speed rating**

Part of a tire designation; indicates the speed range for which a tire is approved.

### **Traction**

Force exerted by the vehicle on the road via the tires.

### **VIN**

(Vehicle Identification Number)

The number set by the manufacturer and stamped on the body to uniquely identify each vehicle produced.

### **Voice control system\***

Voice control system for car phones, portable cell phones and audio systems (radio, CD, etc.).

**A**

- ABC 220, 401
  - Messages in display 313, 318
  - Setting vehicle level 219, 221
- ABS 77, 401
  - Malfunction indicator lamp 304
  - Messages in display 314
  - Warning lamp 304
- Accelerator position, automatic transmission 170
- Accident
  - In case of 50
- Activating
  - Air conditioner (cooling) 191
  - Air conditioning 190
  - Air recirculation mode 187
  - Anti-theft alarm system 84
  - Central locking (control system) 159
  - Charcoal filter 188
  - Distance warning function\* 215
  - Distronic\* 211
  - Easy-entry/exit feature 160
  - ESP 81
  - Exterior lamps 125
  - Exterior rear view mirror parking position 175
  - Front and rear fog lamp 126, 127
  - Hazard warning flasher 129
  - Headlamps 47
  - High beams 128
  - Ignition 31
  - Ignition with KEYLESS-GO\* start/stop button 33
  - Immobilizer 53, 83
  - Limiting opening height of trunk lid\* 159
  - Rear window defroster 189
  - Residual heat 191
  - Seat heater 114, 116
  - Seat ventilation\* 117
  - Tow-away alarm 85
  - Windshield wipers 48
- Activating steering wheel gearshift control
  - Downshifting 169, 172
  - Upshifting 169, 172
- Adding
  - Coolant 279
  - Engine oil 277
- Additional turn signals 353
- Adjustable air vents, rear passenger compartment 192
- Adjusting 34
  - Air distribution 184
  - Air volume 186
  - Backrest tilt 35
  - Drive-dynamic seat 163
  - Exterior rear view mirror 38
  - Head restraint height 36
  - Head restraint tilt 36
  - Instrument cluster illumination 131
  - Interior rear view mirror 38
  - Lumbar support 112
  - Mirrors 38
  - Multicontour backrest\* 112
  - Power seat bench\* 118
  - Seat cushion depth 35, 112
  - Seat cushion tilt 35
  - Seat fore and aft adjustment 35
  - Seat height 35
  - Seat in the lumbar region 113
  - Seat in the shoulder region 112
  - Seats 34
  - Steering column height 37
  - Steering column in or out 37



## Index

- Steering column up or down 37
- Steering wheel 37
- Air conditioning
  - Turning off 190
  - Turning on 190
- Air pressure see Tire inflation pressure 283
- Air recirculation mode 187
  - Activating 187
  - Deactivating 188
- Air vents, rear passenger compartment
  - Adjustable 192
- Air volume
  - Adjusting 186
- AIRBAG OFF indicator lamp 311
- Airbags 59
  - BabySmart™ airbag deactivation system 71, 401
  - Children 60
  - Front 63
  - Passenger 63
  - Safety guidelines 62
  - Side impact 63
  - Window curtain 63
- AIRMATIC 218
- Alarm
  - Audible 76, 84
  - Canceling 84
  - Visual 83
- Alarm system
  - Anti-theft 83
- Alignment bolt 364
- Alignment bolt (vehicle tool kit) 345, 401
- Antiglare
  - Automatic 174
- Antilock brake system (ABS) 401
- Anti-theft alarm system
  - Arming 84
  - Canceling alarm 84
  - Disarming 84
- Anti-theft systems 83
  - Anti-theft alarm system 83
  - Immobilizer 83
  - Tow-away alarm 85
- Aquaplaning see Hydroplaning 263
- Armrest
  - Storage compartment in front of 232, 233, 234
- Ashtray 238
- At the gas station 269
- ATF (Automatic Transmission Fluid) 278
- AUDIO menu 139
  - Operating
    - Cassette player 141
    - Selecting radio station 140
    - Selecting satellite radio\* station (USA only) 140
- Audio system
  - CD mode 142
- Automatic antiglare for rear view mirror 174
- Automatic central locking
  - Activating/deactivating (control system) 159
- Automatic climate control 180
  - Air recirculation mode 187
  - Defrosting 187
  - Rear window defroster 189
  - Setting the temperature 183
- Automatic headlamp mode 125

- Automatic lighting control
  - Activating 129
  - Deactivating 130
- Automatic locking when driving 106
- Automatic transmission 164
  - Accelerator position 170
  - Comfortable program mode 170
  - Deactivating steering wheel gearshift control 173
  - Emergency operation (Limp Home Mode) 173
  - Fluid level 278
  - Gear ranges 166
  - Gear selector lever position 167
  - Gear shifting malfunctions 173
  - Kickdown 170
  - One-touch gearshifting 165
  - Program mode selector switch 170
  - Selector lever position 164
  - Starting the engine 43
  - Steering wheel gearshift control (Speedshift) S 55 AMG 168
  - Transmission fluid 278
  - Winter program mode 171
- Auxiliary fuse box 374
  
- B**
- BabySmart™
  - Airbag deactivation system 71
  - Compatible child seats 71, 401
  - Self-test 71
- BabySmart™ airbag deactivation system 401
- Backrest supports
  - Lumbar region 113
  - Shoulder region 112
- Backup lamps 354, 358
  - Bulbs 354
- BAS 78, 401
  - Messages in display 315
- Batteries, SmartKey
  - Changing 350
  - Check lamp 90, 91
  - Replacing 349
- Battery discharged
  - Jump starting 369
- Battery, SmartKey with KEYLESS-GO\*
  - Changing 351
  - Check lamp 95
  
- Battery, vehicle 280, 366
  - Charging 367
  - Disconnecting 367
  - Reconnecting 368
  - Reinstalling 367
  - Removing 367
- Bi-Xenon headlamps 401
- Block heater (Canada only) 293
- Blocking
  - Rear window operation 74
- Brake assist system (BAS) 401
- Brake fluid 270, 394
- Brake lamp bulbs 354
- Brake lamp, high mounted 354
- Brake pads
  - Message in display 321
- Brakes 260
  - Warning lamp 305
- Break-in period 258
- Bulbs, replacing 353
  - Additional turn signals 353
  - Backup lamps 354
  - Brake lamps 354

## Index

- Fog lamps 353
  - Front lamps 353
  - High beam 353
  - High mounted brake lamp 354
  - License plate lamps 354, 358
  - Low beam 353
  - Parking and standing lamps 353
  - Parking lamps 354, 357
  - Rear fog lamp 354
  - Rear fog lamps 358
  - Side marker lamps 353, 357
  - Standing lamps 353, 354, 357
  - Tail lamp assemblies 354, 358
  - Turn signal lamps 353, 354
- C**
- CAC (Customer Assistance Center) 402
  - Calling up
    - Distronic\* settings 147
    - Range (distance to empty) 150
    - Service indicator 295
  - CAN system 402
  - Cargo tie-down hooks 230
  - Cassette player
    - Operating 141
  - Catalytic converter 267
  - CD changer\* 142
  - CD mode 142
  - CD player
    - Operating 141
  - Center console 25
    - AIRBAG OFF indicator lamp 311
  - Centigrade
    - Setting temperature units 154
  - Central locking
    - Automatic 106
    - From inside 107
    - Switch 107
    - Switching on/off (control system) 159
    - Unlocking from inside 107
  - Changing
    - Batteries (SmartKey) 350
    - Battery (SmartKey with KEYLESS-GO\*) 351
  - CDs 142
  - SmartKey setting 160
    - Vehicle level 219, 222
  - Charcoal filter 188
    - Activating 188
    - Deactivating 189
  - Charging
    - Vehicle battery 367
  - CHECK ENGINE malfunction indicator lamp 306
  - Checking
    - Brake fluid 270
    - Coolant level 278
    - Oil level 271, 273
    - Oil level via control system 274
    - Tire inflate pressure 271
    - Vehicle lighting 271
  - Child safety 69
    - Airbags 60
    - Infant and child restraint systems 64, 69
    - LATCH child seat anchors 73
  - Cigarette lighter 239

- Cleaning
  - Cup holder 301
  - Distronic\* system sensor cover 299
  - Gear selector lever 301
  - Hard plastic trim items 301
  - Headlamps 177
  - Headliner and shelf below rear window 301
  - Instrument cluster 301
  - Leather upholstery 302
  - Light alloy wheels 301
  - Nubuck leather upholstery 302
  - Parktronic\* system sensor 299
  - Plastic and rubber parts 302
  - Seat belts 301
  - Steering wheel 301
  - Upholstery 302
  - Windows 300
  - Windshield 49
  - Wiper blades 299
  - Wood trims 302
- Clock 23
- Closing
  - Cup holder 237
  - Glove box 231
  - Hood 273
  - Power windows with KEYLESS-GO\* 198
  - Side windows 196
  - Sliding/pop-up roof 199, 352
  - Sliding/pop-up roof with KEYLESS-GO\* 202
  - Sliding/pop-up roof with SmartKey 201
  - Trunk lid 98
  - Windows 195
  - Windows with SmartKey 197
- Closing from the inside
  - Trunk 100
- Closing sliding/pop-up roof
  - In an emergency 352
- Cockpit 20, 402
- Cockpit management and data system (COMAND) 402
- COMAND 402
- COMAND\* see separate operating instructions
- Combination switch 128
  - High beam flasher 48, 128
  - Turn signals 47
  - Windshield wipers 48
- Comfortable driving
  - Transmission program mode 170
- Consumer information 399
- Control and operation of radio transmitters 266
- Control system 134, 402
  - AUDIO menu 139
  - Checking oil level 274
  - Convenience submenu 160
  - Display digital speedometer 139
  - Distronic\* menu 147
  - Functions 136, 138
  - Instrument cluster submenu 154
  - Lighting submenu 155
  - Malfunction memory menu 150

## Index

- Menus 137, 138
  - Multifunction display 134
  - Multifunction steering wheel 135
  - NAVI menu 147
  - Settings menu 151
  - Standard display menu 139
  - Submenus 136, 138
  - TEL\* menu 144
  - Trip computer menu 148
  - Vehicle submenu 159
  - Convenience submenu 160
    - Activating easy-entry/exit feature 160
    - Adjusting drive-dynamic seat 163
    - Setting Key-dependency 160
    - Setting parking position for exterior rear view mirror 162
  - Coolant 278
    - Adding 279
    - Checking level 278
    - Messages in display 322, 323
    - Temperature 268
    - Temperature gauge 132
    - Warning lamp 323
  - Coolant level
    - Checking 278
  - Coolant temperature gauge 23
  - Courtesy lighting 130
  - Cruise control 203, 402
    - Canceling 204
    - Driving downhill 204
    - Driving uphill 204
    - Fine adjustment 205
    - Lever 210
    - Setting current speed 204
    - Setting to last stored speeds 205
  - Cruise control lever 203
  - Cup holder
    - Cleaning 301
    - Closing 237
    - In front seat armrest 236
    - In rear seat armrest 237
    - Opening 237
  - Customer Assistance Center (CAC) 402
- D**
- Daytime running lamp mode 126
    - Setting 156
  - Deactivating
    - Air conditioner (cooling) 190
    - Air recirculation mode 188
    - Alarm 84
    - Anti-theft alarm system 84
    - Automatic climate control 190
    - Central locking (control system) 159
    - Charcoal filter 189
    - Cruise control 204
    - Defrost 187
    - Distance warning function\* 215
    - DISTRONIC\* 213
    - Engine with the SmartKey 53
    - ESP 80
    - Exterior lamps 125
    - Hazard warning flasher 129
    - Headlamps 53
    - Immobilizer 83
    - Interior illumination delayed switch-off 158

- Limiting opening height of
  - trunk lid\* 159
- Rear window defroster 189
- Residual heat 191
- Seat heater 115, 116
- Seat ventilation\* 117
- Tow-away alarm 85
- Deactivating steering wheel gearshift control 173
- Deceleration
  - With Distronic\* 209
- Deep water see Standing water 265
- Defrosting 187
- Delayed switch-off
  - Interior illumination 158
- Dialing
  - A number (telephone) 145
- Difficulties
  - While driving see Problems while driving 50
- Digital clock 23
- Digital speedometer 139
- Direction of rotation (tires) 283
- Discharged battery
  - Jump starting 369
- Disconnecting
  - Vehicle battery 367
- Displays
  - Digital speedometer 139
  - Distronic\* 208
  - Messages 275, 312
  - Service indicator 294
  - Showing malfunctions 150
- Distance
  - Decreasing in Distronic\* 214
  - Increasing in Distronic\* 214
  - Setting in Distronic\* 213
  - Warning function 214
- Distance to empty (range)
  - Calling up 148
- Distance warning function\* 214
  - Activating 215
  - Deactivating 215
  - DTR\* warning lamp 214
  - Intermittent warning sound 214
  - Symbol in multifunction display 147
- Distronic\* 206, 402
  - Activated 210
  - Activating 211
  - Calling up settings 147, 209
  - Cleaning system sensor 299
  - Cruise control lever 210
  - Deactivated 210
  - Deactivating 213
  - Deceleration 209
  - Decreasing distance 214
  - Decreasing time interval 213
  - Displays in the speedometer dial 208
  - Distance warning function 214
  - Driving hints 215
  - Fine adjustment 212
  - Increasing distance 214
  - Increasing time interval 213
  - Intermittent signal tone 208
  - Menu 209
  - Messages in display 315
  - Sensor cover 299
  - Setting a higher speed 211
  - Setting a slower speed 212

## Index

- Setting following distance 213
  - Setting the current speed 211
  - Setting to last stored speed ("Resume" function) 212
  - Warning and indicator lamps 208
  - Door control panel 19, 28
  - Door unlock
    - With Tele Aid\* 249
  - Doors
    - Message in display 325
    - Opening from inside vehicle 96
    - Opening from outside 89
  - Downhill driving
    - Cruise control 204
  - Downshifting 165, 169, 172
  - Drink holder see Cup holder 236
  - Drinking and driving 259
  - Drive-dynamic seat
    - Adjusting 163
  - Drive-dynamic seat\* 113
  - Driving
    - Abroad 266
    - General instructions 40, 259
    - Hydroplaning 263
    - In winter 264
    - Problems 50
    - Safety systems 77
      - Through standing water 265
      - With DISTRONIC\* 215
  - Driving abroad 266
  - Driving instructions 259
  - Driving off 261
  - Driving safety systems
    - 4MATIC 82
    - ABS 77
    - BAS 78
    - ESP 79
  - Driving systems 203
    - ABC 220
    - AIRMATIC 218
    - Cruise control 203
    - DISTRONIC\* 206
    - Driving safety systems 77
    - Parktronic\* 224
    - Vehicle level control 219, 221
- ## E
- Easy-entry/exit feature 108
    - Activating 160
    - Interrupting movement 161
  - Electrical fuses 374
  - Electrical system 389
  - Electrically folding exterior rear view mirrors 176
  - Electronic Stability Program see ESP 79, 403
  - Emergency call system\* 242
  - Emergency calls
    - Initiating an emergency call 245
    - With Tele Aid\* 244
  - Emergency engine shut-down 376
  - Emergency operation (Limp Home Mode) 173
  - Emergency operations
    - Closing sliding/pop-up roof 352
    - Locking the vehicle 349
    - Opening sliding/pop-up roof 352
    - Remote door unlock 249
    - Unlocking the trunk lid 349
    - Unlocking the vehicle 348

- Emergency tensioning device see ETD 67, 403
  - Emission control 267
  - Ending
    - A call (telephone) 145
  - Engine 382
    - Compartment 272
    - Message in display 306
    - Starting 43
    - Starting with KEYLESS-GO\* 44
    - Starting with the SmartKey 43
    - Turning off with the SmartKey or the SmartKey with KEYLESS-GO\* 53
  - Engine cleaning 298
  - Engine compartment 272
    - Fuse box in 375
    - Hood 272
  - Engine malfunction indicator lamp 306
  - Engine number 402
  - Engine oil 273
    - Adding 277
    - Additives 393
    - Checking level 273
    - Consumption 273
  - Display messages 326
  - Filler neck 277
  - Messages in display 275, 326
  - Viscosity 403
  - Engine oil level see Oil level 271
  - Engine shut down in an emergency 376
  - Entry position
    - Messages in display 328
  - ESP 79, 403
    - Four wheel electronic traction system with ESP 82
    - Switching off 80
    - Switching on 81
    - Synchronizing 316
    - Warning lamp 307, 308
  - ETD 403
    - Safety guidelines 62
  - ETD (Emergency tensioning device) 67
  - Exterior lamp switch 124
  - Exterior rear view mirrors
    - Adjusting 38
    - Folding electrically 176
    - Parking position for 162
- F**
- Fahrenheit
    - Setting temperature units 154
  - Fastening the seat belts 40
  - Fine adjustment
    - Cruise control 205
    - Distronic\* 212
  - First aid kit 344
  - Flat tire 361
    - Lowering the vehicle 365
    - Mounting the spare wheel 361
    - Preparing the vehicle 361
  - Flexible Service System (FSS) 294, 403
  - Fog lamp, rear 127, 354
  - Fog lamps
    - Replacing bulbs 353
  - Fog lamps, front
    - Messages in display 330
    - Replacing bulbs 354
    - Switching on 127
  - Folding electrically
    - Exterior rear view mirrors 176



## Index

Four wheel electronic traction system  
(4MATIC)  
  with ESP 82  
4MATIC 82  
Front airbags 63  
Front lamps  
  Messages in display 330–333  
  Replacing bulbs 353, 355  
  Switching on 124  
Front seat head restraints  
  Installing 109  
  Power seat 109  
  Removing 109  
FSS (Flexible Service System) 294, 403  
Fuel 270  
  Fuel reserve warning lamp 308  
  Premium unleaded gasoline 270  
Fuel consumption statistics  
  After start 148  
  Since last reset 149

Fuel filler flap 269  
  Locking 269  
  Opening 351  
  Unlocking 269  
Fuel tank  
  Filler flap 269  
Fuels, coolants, lubricants etc. 391  
Functions (control system) 136, 138  
  Resetting 152  
Fuse box 374, 375  
Fuse chart 345  
Fuses 374  
  Auxiliary fuse box in trunk 374  
  Fuse box in engine compartment 375  
  Fuse box in passenger  
    compartment 374  
  Fuse boxes in the engine  
    compartment 376  
  Fuse chart 345  
  Fuse extractor 345  
  Spare fuses 345

## G

Garage door opener 250  
  Erasing in remote control 255  
  Integrated remote control 252  
  Rolling code programming 253  
Gasoline see Fuel 270  
Gear range 403  
  Automatic transmission 166  
  Limiting 166  
  Shifting into optimal 165  
Gear range limit  
  Canceling 165  
Gear selector lever  
  Cleaning 301  
  Position 167  
Glasses  
  Storage compartment in front of  
    armrest 234  
Global  
  Locking 89  
  Unlocking 89

- Global Positioning System (GPS) 403
- Glove box 231
  - Closing 231
  - Locking 231
  - Opening 231
  - Unlocking 231
- Gloves (vehicle tool kit) 345
- Good visibility 174
- GPS 243, 403
- H**
- Hand-held transmitter
  - Programming integrated remote control 252
- Hands-free microphone 27
- Hard plastic trim items
  - Cleaning 301
- Hazard warning flasher 128
  - Switching off 129
  - Switching on 129
- Head restraint folding 119
- Head restraints 109
- Headlamp cleaning system\* 281
- Headlamps
  - Automatic control 125
  - Bi-Xenon 401
  - Cleaning 298
  - Cleaning system\* 177, 281
  - Refilling washer fluid 281
  - Switching off 53
  - Switching on 47
- Headliner
  - Cleaning 301
- Heated steering wheel\* 240
- Height adjustment
  - Head restraints 36
  - Steering wheel 37
- Height adjustments
  - Vehicle level 219, 221
- High beam
  - Replacing bulbs 353
- High beam flasher 48, 128
- High beam headlamps
  - Messages in display 330
  - Switching on 128
- High mounted brake lamp 354
- Hood 272
  - Closing 273
  - Message in display 328
  - Opening 272
- Hydroplaning 263
- I**
- Identification labels 380
- Ignition 31, 33
  - Switching on 43, 44
- Immobilizer 83
  - Activating 83
  - Deactivating 83
- Indicator lamps see Lamps, indicator and warning
- Individual seats\* 118
- Infant and child restraint systems 69
  - Installing 72
  - LATCH child seat anchors 73
- Information
  - About service and warranty 10
  - Button for Tele Aid\* 247
- Infrared reflecting windshield 256

## Index

- Inside rear view mirror
    - Antiglare 174
  - Installing
    - Infant and child restraint systems 72
    - Towing eye bolt 373
    - Wiper blades 360
  - Instrument cluster 22, 131, 403
    - Cleaning 301
    - Coolant temperature gauge 132
    - Illumination 131
    - Multifunction display 134
    - Outside temperature indicator 133
    - Selecting language 155
  - Integrated remote control
    - Canadian programming 254
    - Erasing memory 255
    - Hand-held transmitter 252
    - Operating 255
    - Rolling code programming 253
  - Interior illumination
    - Delayed switch-off 158
  - Interior lighting 129
    - Activating automatic control 129
    - Deactivating automatic control 130
    - Manual operation 130
  - Interior rear view mirror
    - Adjusting 38
  - J**
  - Jump starting 369
  - K**
  - Key see SmartKey 30, 53
  - Key, mechanical 348
  - Key, SmartKey
    - Positions in starter switch 31
  - Key, SmartKey, SmartKey with KEYLESS-GO\*
    - Replacing the battery 349
  - Key-dependency memory
    - Settings 160
  - KEYLESS-GO\* 403
    - Activating ignition with 33
    - Closing power windows 198
    - Closing sliding/pop-up roof 202
  - Locking the vehicle 95
  - Loss of SmartKey with KEYLESS-GO 96
  - Messages in display 328
  - Starting the engine 44
  - Turning off engine 54
- Kickdown 170, 403
  - Kilometers/miles in speedometer 154
  - Km/h or mph in speedometer 154
- L**
- Lamp bulbs, exterior 353
- Lamps, exterior
  - Front 353
  - Light sensor 331
  - Messages in display 331
  - Rear 354
- Lamps, indicator and warning
  - ABS 304
  - Airbag Off 63
  - Battery (SmartKey with KEYLESS-GO\*) 94
  - Battery (SmartKey) 89
  - Brakes 305

- CHECK ENGINE 306
- Coolant 322
- DTR\* 208
- Engine diagnostics 306
- ESP 307, 308
- Fuel reserve 308
- Instrument cluster 308
- Seat belts 308
- Service indicator 294
- SRS 59
- Language
  - Multifunction display 155
  - Setting 155
- LATCH child seat anchors 73
- Layout of poly-V-belt drive 381
- Leather upholstery
  - Cleaning 302
- Lever
  - For cruise control 210
- License plate lamps
  - Replacing bulbs 354, 358
- Light alloy wheels
  - Cleaning 301
- Light sensor 331
- Lighter see Cigarette lighter 239
- Lighting 124
  - Automatic headlamp mode 125
  - Combination switch 128
  - Daytime running lamp mode 126
  - Exterior lamp switch 124
  - Front fog lamps 127
  - High beam flasher 128
  - High beams 128
  - Instrument cluster illumination 131
  - Interior 129
  - Locator lighting 126
  - Low beam 124
  - Manual headlamp mode 125
  - Night security illumination 126
  - Parking lamps 124
  - Rear fog lamp 127
  - Settings (control system) 155
- Limiting the gear range 166
- Limp Home Mode 173
- Loading 229
  - Cargo tie-down hooks 230
  - Instructions 229
  - Roof rack 229
- Locator lighting 126
  - Setting 156
- Lock button 403
- Lock buttons
  - Door handle (KEYLESS-GO\*) 55
- Locking 51, 88
  - Fuel filler flap 269
  - Global (SmartKey with KEYLESS-GO\*) 94
  - Global, SmartKey 89
  - Glove box 231
  - The vehicle with KEYLESS-GO\* 95
  - Trunk lid, separately 105
  - Vehicle in an emergency 349
- Loss of SmartKey 91
- Loss of Smartkey with KEYLESS-GO\* 96
- Low beam headlamps
  - Messages in display 330, 331
  - Replacing bulbs 353
- Lowering
  - Vehicle 365
- Lumbar support adjustment 112

## Index

### M

- Main 390
- Main Dimensions 390
- Maintenance 12, 294
- Malfunction
  - Displaying 150
- Malfunction memory 150
  - Calling up 150
- Manual headlamp mode 125
- Manual operations
  - Fuel filler flap 351
  - Interior lighting control 130
  - Locking the vehicle 349
  - Sliding/pop-up roof 352
  - Unlocking the driver's door 348
  - Unlocking the trunk lid 349
- Massage function 113
- MAXCOOL
  - Maximum cooling 186
- Mechanical key 348
- Memory function 121, 403
  - Recalling positions from memory 122
  - Storing exterior rear view mirror parking positions 122
- Storing key dependent settings 122
- Menus 136
  - AUDIO 139
  - Distronic\* 147, 209
  - In control system 137, 138
  - Malfunction memory 150
  - NAVI 147
  - Settings menu 151
  - Standard display 139
  - Submenus 136
  - TEL\* 144
  - Trip computer 148
- Microphone
  - Hands-free microphone 27
- Miles/kilometers in speedometer
  - Setting 154
- Mirrors
  - Activating exterior rear view mirror parking position 175
  - Adjusting 38
  - Automatic antiglare for rear view mirror 174
  - Exterior rear view mirror 38
  - Exterior rear view mirror parking position 162
  - Interior rear view mirror 38
  - Storing exterior rear view mirror parking position 122
- MON 270
- MON (Motor Octane Number) 404
- Mph or km/h in speedometer 154
- Multicontour backrest\* 112
- Multifunction display 134, 404
  - Selecting language 155
  - Standard display 138
- Multifunction display messages
  - ABC 313, 318
  - ABS 314
  - BAS 315
  - Brake fluid 321
  - Brake pads 321
  - Check engine 306
  - Coolant 323
  - Coolant level 322
  - Distronic\* 315
  - Doors 325
  - Engine 306
  - Engine oil level 326

Entry position 328  
 Hood 328  
 Lamps 331  
 Parking brake 321  
 Selector lever 317  
 SmartKey 328  
 SmartKey with KEYLESS-GO\* 328  
 TeleAid 334  
 Telephone\* 334  
 Tires 336, 339  
 Trunk 334  
 Washer fluid 334  
 Multifunction steering wheel 24, 135, 404  
   Buttons 135  
**N**  
 Navigation system  
   Operating 147  
   See separate COMAND\* operating instructions  
 Night security illumination 126  
 Nubuck leather upholstery  
   Cleaning 302

**O**  
 Occupant safety 58  
   Airbags 59  
   Children and airbags 60  
   Children in the vehicle 69  
   Fastening the seat belt 40  
   Infant and child restraint systems 69  
   LATCH child seat anchors 73  
   Seat belts 40, 62  
 Oil  
   Adding 277  
   Consumption 273  
   Dipstick 273  
   Filler neck 277  
   Viscosity 403  
 Oil level  
   Checking 271  
 Oil level via control system  
   Checking 274  
 One-touch gearshifting 165  
   Canceling gear range limit 165  
   Downshifting 165  
   Upshifting 165

Opening  
   Ashtray 238  
   Cup holder 237  
   Doors from the inside 96  
   Fuel filler flap 269  
   Fuel filler flap manually 351  
   Glove box 231  
   Hood 272  
   Side windows 196  
   Sliding/pop-up roof 199, 352  
   Sliding/pop-up roof in an emergency 352  
   Sliding/pop-up roof with SmartKey 201  
   Storage compartment in the center console 232  
   Storage compartments in the armrest 233  
   Storage compartments in the center console 233, 234  
   Trunk 97  
   Trunk lid from the inside 97  
   Windows 195  
   Windows with SmartKey 197

## Index

- Opening from the inside
  - Trunk 99
- Operating
  - Cassette player 141
  - CD player 141
  - COMAND\* see separate operating instructions
  - Garage door opener 255
  - Integrated remote control 255
  - Navigation system 147
  - Radio 140
  - Radio transmitters 266
  - Telephone\* 144
  - Vehicle outside the USA and Canada 13
- Operator's Manual 10
- Ornamental moldings 298
- Outside temperature indicator 133
- Overdue service 294
- Overhead control panel 27
  - Garage door opener 27
  - Reading lamp 27
  - Rear view mirror 27
  - Tele Aid button 27
- Override switch see Blocking of rear window operation 74
- Overspeed range 404
- P**
- Paintwork 297
- Panic alarm 76
  - Panic button on SmartKey 76
- Parcel net in front passenger footwell 237
- Parcel net in trunk 238
- Parking 51, 261
- Parking and standing lamps
  - Replacing bulbs 353
- Parking assist see Parktronic\* 224
- Parking brake 45, 52
  - Engaging 52
  - Message in display 321
  - Releasing 45
  - Warning sound 46
- Parking lamps
  - Replacing bulbs 354, 357
  - Switching on 124
- Parking position
  - Exterior rear view mirrors 122, 162, 175
- Parktronic 224
- Parktronic\* 224, 404
  - Malfunctioning 228
  - Sensor 299
- Passenger compartment 266
  - Fuse box in 374
  - Interior lighting 129
  - Interior rear view mirror 38
  - Parcel net in front passenger footwell 237
- Passenger safety see Occupant safety 58
- Passenger seat fore and aft adjustment 120
- Passenger seat head restraint height 120
- Passenger seat height 120
- Pedals 259
- Phone book\*
  - Loading 146
  - Quick search 146

- Phone number\*
  - Dialing 145
  - Redialing 146
- Plastic and rubber parts
  - Cleaning 302
- Poly-V-belt drive 404
- Positions (Memory function)
  - Recalling from memory 122
- Positions (Memory function\*)
  - Storing into memory 122
- Power assistance 259
- Power seat
  - Adjusting backrest tilt 35
  - Adjusting head restraint height 36
  - Adjusting head restraint tilt 36
  - Adjusting seat cushion depth 35
  - Adjusting seat cushion tilt 35
  - Adjusting seat height 35
  - Front seat head restraints 109
  - Seat fore and aft adjustment 35
- Power seat bench\* 118
- Power train 404
- Power washer 297
- Power windows 195
  - Blocking of rear window operation 74
  - Closing with KEYLESS-GO\* 198
  - Side windows 195
  - Synchronizing 198
- Practical hints
  - First aid kit 344
  - Fuses 374
  - Lamp in center console 311
  - Lamps in instrument cluster 304
  - Messages in the display 312
  - Towing the vehicle 371
  - Vehicle tool kit 344
- PRE-SAFE see Preventive occupant safety 68
- Preventive occupant safety (PRE-SAFE) 68
- Problems
  - While driving 50
  - With vehicle 17
- Product information 9
- Program mode selector switch 404
  - Automatic transmission 170
- PULSE function (Massage function) 113
- Q**
  - Quick search
    - Phone book\* 146
- R**
  - Radio
    - Selecting satellite radio\* stations 140
    - Selecting stations 140
  - Radio transmitters, control and operation 266
  - Range (distance to empty)
    - Calling up 150
  - Rear fog lamp 354
    - Bulb 354
    - Switching on 127
  - Rear lamp bulbs
    - Replacing 358
  - Rear lamps see Tail lamps
  - Rear passenger compartment
    - Adjustable air vents 192
  - Rear seat head restraints
    - Folding back with switch 110
    - Placing upright 110
  - Rear seats 110



## Index

- Rear seats 118
  - Fore and aft adjustment 119
  - Head restraint folding 119
  - Individual seats\* 118
  - Passenger seat fore and aft adjustment 120
  - Passenger seat head restraint height 120
  - Passenger seat height 120
  - Rear seat head restraints 110
  - Seat height 119
  - Setting front passenger seat position from rear\* 119
- Rear view mirror 27
- Rear view mirror automatic antiglare 174
- Rear view mirrors see Mirrors
- Rear window
  - Blocking operation 74
- Rear window defroster 189
  - Activating 189
  - Deactivating 189
- Rear window sunshade\* 179
- Reconnecting
  - Vehicle battery 368
- Refueling 269
- Regular checks 270
- Regular driving style 221
- Reinstalling vehicle battery 367
- Remote controls
  - Integrated 252
  - SmartKey 88, 92
- Remote door unlock
  - With Tele Aid\* 249
- Remote Vehicle Diagnostics 405
- Removing
  - Vehicle battery 367
  - Wheel 364
  - Wiper blades 359
- Replacing
  - Backup lamp bulbs 358
  - Brake fluid 394
  - Brake lamp bulbs 358
  - Bulbs 353
  - Front lamp bulbs 355
  - License plate lamp bulbs 358
  - Parking lamp bulbs 357
  - Rear fog lamp bulbs 358
  - Rear lamp bulbs 354, 358
- Rear turn signal bulbs 358
- Side marker lamp bulbs 357
- Standing lamp bulbs 357
- Wiper blades 359
- Reporting
  - Safety defects 18
- Reset button in the instrument cluster 151
- Resetting
  - All functions (control system) 151
  - All functions of a submenu 152
  - Fuel consumption 149
  - Service indicator (FSS) 295
  - Trip odometer 132
- Residual heat utilization 191, 405
- Residual ventilation 191
- REST (Residual engine heat utilization) 405
- Restraint system see Infant and child restraint systems 69, 72
- Rims and Tires 384
- Roadside assistance 12
  - Tele Aid\* 246
- Rolling code programming 253

- RON 270
- RON (Research Octane Number) 405
- Roof rack 229
- Rotating wheels 291
- Rubber parts
  - Cleaning 302
- S**
- Safety
  - Occupant 58
  - Safety belts see Seat belts 40
  - Safety defects
    - Reporting 18
  - Safety systems
    - Driving 77
  - Screwdriver (vehicle tool kit) 345
  - Seat belt force limiter 67
  - Seat belts 64
    - Cleaning 301
    - Fastening 40
    - Proper use of 42, 66
    - Safety guidelines 62
    - Warning lamp 308
  - Seat cushion depth
    - Adjusting 112
  - Seat for and aft adjustment 119
  - Seat heater
    - Switching off 115
    - Switching on 114
  - Seat height 119
  - Seat ventilation\*
    - Switching off 117
    - Switching on 117
  - Seats 108
    - Adjusting 34
    - Adjusting lumbar support 113
    - Adjusting shoulder support 112
    - Easy entry/exit feature 108
    - Heater 114
    - Massage function 113
    - Multicontour backrest\* 112
    - Rear power seat bench\* 118
    - Rear seats 118
  - Securing cargo
    - Cargo tie-down hooks 230
  - Selector lever
    - Lock 43
    - Message in display 317
    - Position 164
- Self-test
  - BabySmart™ airbag deactivation system 71
  - Tele Aid\* 243
- Service
  - Calling up the service indicator 295
  - Major service (Service B) 294
  - Minor service (Service A) 294
  - Overdue 294
  - Types 294
  - When due 294
- Service (maintenance) 294
- Service and warranty information 10
- Service indicator 294
  - Calling up 295
  - Clearing 294, 295
- Service life (tires) 283
- Service System see FSS 294
- Setting
  - Convenience functions 160
  - Cruise control 204
  - Daytime running lamp mode 156
  - Digital clock 23
  - Distronic\* time interval 213
  - Following distance in Distronic\* 213

## Index

- Higher speed in cruise control 205
- Higher speed in Distronic\* 211
- Individual vehicle settings 151
- Interior illumination delayed switch-off 158
- Lamps and lighting (control system) 155
- Language, multifunction display 155
- Locator lighting 156
- Lower speed in cruise control 205
- Lower speed in Distronic\* 212
- Miles/kilometers in speedometer 154
- Parking position for exterior rear view mirrors 162
- Slower speed in cruise control 205
- Slower speed in Distronic\* 212
- SmartKey dependent memory 160
- Speed in cruise control 205
- Speed in Distronic\* 211
- Speedometer display mode 154
- Suspension tuning 220
- Temperature (interior) 183
- Temperature indicator 154
- Time 23
- To last stored speed in Distronic\* ("Resume" function) 212
- Units
  - Speedometer 154
  - Temperature 154
  - Vehicle level control 219, 221
- Setting current speed 204
- Setting front passenger seat position from rear\* 119
- Settings
  - Calling up Distronic\* 147, 209
  - Convenience functions 160
  - Factory, SmartKey 89
  - Individual (SmartKey) 160
  - Lighting (control system) 155
  - Menus and submenus 136
  - Resetting all (control system) 151
  - Resetting in the submenu 152
  - Selective 89, 94
- Settings menu
  - Functions in 151
  - Individual vehicle settings 151
  - Submenus 152
- Shift lock 405
- Shifting
  - Gear selector lever positions 167
  - Into optimal gear range (automatic transmission) 165
- Shoulder support
  - Seat adjustment 112
- Side impact airbags 63
- Side marker lamps
  - Replacing bulbs 353, 354, 357
- Side windows
  - Automatic closing 196
  - Automatic opening 196
  - Cleaning 300
  - Closing 195, 196, 197
  - Closing fully (Express-close) 196
  - Closing with SmartKey 197
  - Opening 195, 196, 197
  - Opening fully (Express-open) 196
  - Opening with SmartKey 197
  - Stopping 197
  - Synchronizing power windows 198

- Simultaneous wiping and washing
  - Windshield wipers 49
- Single wipe 49
- Sliding/pop-up roof 199
  - Closing 199, 352
  - Closing with KEYLESS-GO\* 202
  - Closing with SmartKey 201
  - Messages in display 333
  - Opening 199, 352
  - Opening with SmartKey 201
  - Stopping 200
  - Synchronizing 202
- SmartKey 30, 88
  - Battery check lamp 89, 94
  - Changing the batteries 350
  - Checking the batteries 91
  - Factory setting 89
  - Global locking 89
  - Global locking and unlocking 89
  - Global unlocking 89
  - Locking and unlocking 88
  - Loss of 91
  - Opening and closing the sliding/pop-up roof with 201
  - Opening and closing windows with 197
  - Remote controls 88, 92
  - Replacing the batteries 349
  - Restoring to factory setting 90
  - Selective setting 89
  - Starting the engine 43
  - Turning off the engine 53
  - Unlocking with 30
- SmartKey positions in starter switch 31
- SmartKey with KEYLESS-GO
  - Checking the battery 95
- SmartKey with KEYLESS-GO\* 91
  - Changing the battery 351
  - Factory setting 94
  - Global locking 94
  - Global unlocking 94
  - Loss of 96
  - Messages in display 328
  - Replacing the battery 349
  - Selective setting 94
  - Unlocking 91
  - Unlocking with 32
- Snow chains 293
- Spare fuses 345
- Spare parts service 378
- Spare wheel
  - Mounting 361
- Speed
  - Setting current 204
  - Setting to last stored speed in Distronic\* ("Resume" function) 212
- Speed settings
  - Cruise control 205
  - Distronic\* 211, 212
- Speedometer
  - Displaying gear range 166
  - Displays 208
  - Settings units 154
- Speedometer display mode
  - Selecting 154
- Sporty driving style 221
- SRS 66, 405
  - Indicator lamp 310
- SRS indicator lamp 58
- Standing lamps 124
  - Replacing bulbs 353, 354, 357

## Index

- Standing water
  - Driving instructions 265
- Starter switch 31
  - Positions 31
- Starting difficulties 44
- Starting position 31
- Starting the engine 43
- Steering column
  - Height adjustment 37
  - Length adjustment 37
- Steering wheel
  - Adjusting 37
  - Adjustment 37
  - Cleaning 301
  - Heated steering wheel\* 240
- Steering wheel adjustment 37
- Stolen vehicle
  - Tracking services 250
- Stopping
  - Sliding/pop-up roof 200
  - Windows 197
- Storage compartments 231
  - Armrest 232, 233, 234
  - Cup holder 236, 237
  - Glove box 231
  - In front of armrest 234
  - Parcel net 237
  - Storage compartment in front of armrest 232, 233
  - Storage tray 232, 233, 234
  - Under the front seats 235
- Storing (Memory function\*)
  - Positions into memory 122
- Submenus
  - Convenience 160
  - For settings 136
  - In control system 138
  - Instrument cluster 154
  - Lighting 155
  - Resetting functions in Control system 152
  - Selecting 152
  - Settings menu 152
  - Vehicle 159
- Sun visors 178
- Supplemental Restraint System (SRS) 405
- Suspension tuning
  - For regular driving style 221
  - For sporty driving style 221
  - Setting 220
- Switching off
  - Automatic central locking (control system) 159
  - Engine 53
  - ESP 80
  - Hazard warning flasher 129
  - Headlamps 53
- Switching on
  - Automatic central locking (control system) 159
  - ESP 81
  - Front fog lamps 127
  - Front lamps 124
  - Hazard warning flasher 129
  - Headlamps 47
  - High beams 128
  - Parking lamps 124
  - Rear fog lamp 127
  - Windshield wipers 48

- Symbol (Distronic\*)
  - Distance warning function\* 147
- Synchronizing
  - ESP 316
  - Power windows 198
  - Sliding/pop-up roof 202
- T**
- Tachometer 133
  - Overspeed range 133
- Tail lamps
  - Cleaning 298
  - Replacing bulbs 354, 358
- Tar stains 297
- Tele Aid
  - Information 247
  - Initiating an emergency call manually 245
  - Roadside assistance 246
  - Tele Aid System 242
- Tele Aid button 27
- Tele Aid System 405
- Tele Aid\* 242
  - Emergency calls 244
  - Remote door unlock 249
- Stolen vehicle tracking services 250
- System self-check 243
- Upgrade signals 248
- TeleAid
  - Messages in display 334
- Telematics\* 405
- Telephone holder\*
  - Storage compartment in front of armrest 234
- Telephone\* 241
  - Answering a call 145
  - Dialing a number from the phone book 145
  - Ending a call 145
  - Hands-free microphone 27
  - Loading phone book\* 146
  - Messages in display 334
  - Operating 144
  - Redialing 146
- Temperature
  - Display mode 154
  - Setting interior temperature 183
  - Setting units in display 154
  - Tires 284
- Tie-down hooks (Trunk) 230
- Tightening torque 405
- Tightening torque (Wheel bolts) 365
- Time
  - Setting digital clock 23
- Tire inflation pressure
  - Checking 271, 283
- Tire inflation pressure see the placard on the fuel filler flap
- Tire speed rating 263, 406
- Tire traction 263
- Tires 282, 399
  - Direction of rotation 283
  - Driving instructions 262
  - Messages in display 336, 339
  - Retreads 282
  - Service life 283
  - Temperature 284
  - Tire pressure monitor warning lamp\* 309
  - Tread depth 292
  - Wear pattern 291
  - Winter 292
- Tools 344

## Index

- Tow-away alarm 85
  - Arming 85
  - Disarming 85
  - Disarming for transport 85
- Towing eye bolt (vehicle tool kit) 345
  - Installing 373
- Towing the vehicle 371
- Tracking services
  - For stolen vehicle 250
- Traction 170, 406
- Transmission see Automatic transmission 278
- Tread depth (tires) 292
- Trip computer 148
- Trip odometer
  - Resetting 132
- Trunk
  - Auxiliary fuse box 374
  - Closing from the inside 100
  - Lock button, KEYLESS-GO\* 95
  - Locking separately 105
  - Message in display 334
  - Opening 97
  - Opening from inside vehicle 97
  - Opening from the inside 99

- Parcel net 238
- Tie-down hooks 230
- Trunk lid 97, 99, 100
- Trunk lock 349
- Unlocking in an emergency 349
- Unlocking separately 105, 106
- Unlocking with SmartKey 90
- Trunk lid
  - Closing 98
- Trunk lid emergency release 104
- Trunk lid opening/closing system\* 99
- Turn signal lamps
  - Replacing bulbs 353, 354
- Turn signals 47
  - Additional in mirrors 353
  - Cleaning lenses 298
  - Front bulbs 353, 356
  - Rear bulbs 354, 358
- Turning off
  - Engine 53
- Turning off the engine 54

## U

- Units
  - Setting speedometer units 154
  - Setting temperature units 154
- Unlocking 30, 88
  - Driver's door in an emergency 348
  - Fuel filler flap 269
  - Global 89
  - Global (SmartKey with KEYLESS-GO\*) 94
  - Glove box 231
  - In an emergency 348
  - Selective settings 89, 94
  - Trunk in an emergency 349
  - Trunk lid with SmartKey 90
  - Trunk lid, separately 105, 106
  - Vehicle in an emergency 249
  - With the SmartKey 30
  - With the SmartKey with KEYLESS-GO\* 32, 91
- Upgrade signals
  - Tele Aid\* 248
- Uphill driving
  - Cruise control 204

- Upholstery
  - Cleaning 302
- Upshifting 165, 169, 172
- Useful features 231
  - Ashtrays 238
  - Cigarette lighter 239
  - Garage door opener 250
  - Heated steering wheel\* 240
  - Storage compartments 231
  - Tele Aid\* 242
  - Telephone\* 241
- V**
- Vehicle
  - Individual settings 151, 153
  - Locking in an emergency 349
  - Lowering 365
  - Service battery 366
  - Towing 371
  - Unlocking in an emergency 348
- Vehicle battery 366
- Vehicle care 296
  - Cup holder 301
  - Distronic\* system sensor cover 299
  - Engine cleaning 298
- Gear selector lever 301
- Hard plastic trim items 301
- Headlamps 298
- Instrument cluster 301
- Leather upholstery 302
- Light alloy wheels 301
- Nubuck leather upholstery 302
- Ornamental moldings 298
- Paintwork 297
- Parktronic\* system sensor 299
- Plastic and rubber parts 302
- Power washer 297
- Seat belts 301
- Side markers 298
- Steering wheel 301
- Tail lamps 298
- Tar stains 297
- Turn signals 298
- Upholstery 302
- Vehicle washing 298
- Window cleaning 300
- Wiper blades 299
- Wood trims 302
- Vehicle level 219, 221
  - Changing 219, 222
  - Setting 219, 222
    - Automatic 219, 222
    - Manual 219, 222
- Vehicle lighting
  - Checking 271
- Vehicle submenu
  - Limiting opening height of trunk lid\*(Control system) 159
- Vehicle tool kit 344, 345
  - Alignment bolt 345
  - Fuse chart 345
  - Fuse extractor 345
  - Gloves 345
  - Screwdriver 345
  - Spare fuses 345
  - Wheel wrench 345
- Vehicle washing 298
- Ventilated storage compartment 192
- Ventilation
  - Storage compartment 192
- VIN (Vehicle Identification Number) 406
- Voice control system\* 406
  - Hands-free microphone 27



## Index

### W

Warning lamps see Lamps, indicator and warning

Warning sounds

Distance warning function\* 214

DISTRONIC\* 208

Drivers seat belts 64

Parking brake 46

Warranty coverage 379

Washing the vehicle 296

Wear pattern (tires) 291

Weights 390

Wheel change

Tightening torque 365

Wheels

Rotating 291

Tires and wheels 282

Window curtain airbags 63

Windows see Side windows

Windshield

Refilling washer fluid 281

Replacing wiper blades 359

Washer fluid 281

Windshield washer fluid

Message in display 334

Refilling 281

Wiping with 49

Windshield wipers 48, 177

Fast wiper speed 48

Intermittent wiping 48

Replacing wiper blades 359

Single wipe 49

Switching on 48

Wiping with windshield washer fluid 49

Winter driving 292

Block heater (Canada only) 293

Snow chains 293

Tires 292

Transmission program mode 171

Winter driving instructions 264

Winter tires 292

Wiper blades

Cleaning 299

Installing 360

Removing 359

Replacing 359

Wiping

And washing simultaneously 49

Interval 48

With windshield washer fluid 49

Wood trims

Cleaning 302

Wrench, wheel (vehicle tool kit) 345

### X

Xenon headlamps

Bi-Xenon 401

### Service and Literature

Your authorized Mercedes-Benz Center has trained technicians and original Mercedes-Benz parts to service your vehicle properly. For expert advice and quality service, see an authorized Mercedes-Benz Center.

If you are interested in obtaining service literature for your vehicle, please contact an authorized Mercedes-Benz Center. We consider this the best way for you to obtain accurate information for your vehicle.

For further information you can find us on the Mercedes-Benz web-site [www.mbusa.com](http://www.mbusa.com) or [www.mercedes-benz.ca](http://www.mercedes-benz.ca).

#### Warning



To help avoid personal injury, be extremely careful when performing any service work or repairs. Improper or incomplete service or the use of incorrect or inappropriate parts or materials may damage the vehicle or its equipment, which may in turn result in personal injury.

If you have any questions about carrying out any type of service, turn to the advice of an authorized Mercedes-Benz Center.

We reserve the right to modify the technical details of the vehicle as given in the data and illustrations of this Operator's Manual. Re-printing, translation and copying, even of excerpts, is not permitted without our prior authorization in writing.

Title illustration no. P00.01-2396-31

Press time 01 / 09 / 04

GSP / TIP

Printed in Germany

Order No. 6515 2164 13 Part No. 220 584 87 96 USA Edition B 2004